

ARCHITECTURAL IRONMONGERY



DOOR CONTROLS



DOOR CONTROLS

SURFACE MOUNTED DOOR CLOSER



Suitable for doors up to 50kg
Double spring closing
For 30-minute fire resistant doors if used in conjunction with a lock or latch mechanism

Product code: 510011

CONCEALED DOOR CLOSER



For doors up to 50kg (two can be fitted to doors over 50kg)
Suitable for 30-minute fire resistant doors
Tested to BS 476 PT22: 1987
Finishes in stock:
Satin chrome
Electro brass

Product code: SC: 510012 EB: 510013

ZOO OVERHEAD DOOR CLOSER: LIGHT DUTY

BEST SELLER



Fixed power size 3
For inward and outward opening doors
Suitable for doors up to 60kg and 950mm wide
Adjustable closing speed and latch speed
10-year manufacturer's warranty
Certifire Rated
Tested to BS EN 1154
Finish: Silver

Product code: 510009

DORMA OVERHEAD DOOR CLOSER: LIGHT DUTY



Power size 2 - 4
For inward and outward opening doors
Suitable for doors up to 1100mm width
Adjustable closing speed and reliable latching action
Certifire approved
Tested to BS EN 1154
Finish: Silver

Product code: 510005

ZOO OVERHEAD DOOR CLOSER: MEDIUM DUTY WITH OPTIONAL DELAYED ACTION FACILITY

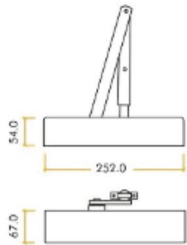

Power size 2-4 adjustable by spring
For inward and outward opening doors
Semi-radiused cover & adjustable flat arm
Latching action and adjustable power by spring
Adjustable Delayed Action facility
Suitable for doors up to 80Kg in weight and 1100mm in width
10-year manufacturer's warranty
Tested to BS EN 1634-1
Tested to BS EN 1154
Certifire rated

Product code:

Finish:

510017

Silver

510018

SSS

510019

PVD Gold



CAM ACTION DOOR CLOSER



Power size 2-4 adjustable by valve
Adjustable closing power, speed, latch action and backcheck
Certifire rated
Tested to BS EN 1634-1: 2-hour timber fire doors
Tested to BS EN 1154
Capable of meeting the opening force requirements of ADM and BS8300

Product code:

Finish:

Fitting side:

006584

SSN

Pull side

510004

Silver

Pull side

006561

SSN

Push side

510003

Silver

Push side

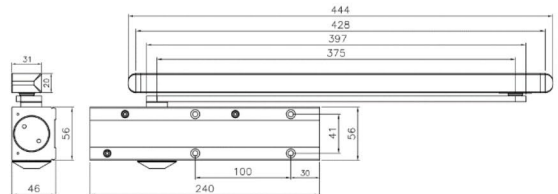

NHN OVERHEAD DOOR CLOSER: MEDIUM DUTY



Power size 2-4 adjustable by spring
For inward and outward opening doors
Latching action and adjustable power
Suitable for doors 40-80Kg in weight and 850-1100mm in width
10-year manufacturers guarantee
Tested to BS EN 1634-1: 2-hour timber fire doors
Tested to BS EN 1154
Finish: Silver

Product code: 510010

SYNERGY OVERHEAD DOOR CLOSER: MEDIUM DUTY



Power size 2 - 4 adjustable by template
For inward and outward opening doors
Suitable for doors up to 80Kg and 1100mm width
Adjustable closing speed and latch action
Certifire rated
Tested to BS EN 1634-1: 2-hour timber fire doors
Tested to BS EN 1154
Finish: Silver

Product code: 510000

ARCHITECTURAL IRONMONGERY

DOOR CONTROLS



DOOR CONTROLS

SYNERGY OVERHEAD DOOR CLOSER: MEDIUM DUTY



Power size 2 - 4 adjustable by spring
Suitable for inward and outward opening doors
Suitable for doors up to 80kg and 1100mm width
Adjustable closing speed, latch action and backcheck
Elegant radiused cover
Certifire rated
Capable of meeting the requirements of BS8300 and Approved Document M
Tested to BS EN 1634-1: 2-hour timber fire doors
Tested to BS EN 1154
Finishes in stock: Silver, Satin nickel & Polished brass

Product code: S: 510001, SN: 510002, PB: 006981

DORMA OVERHEAD DOOR CLOSER: MEDIUM DUTY

BEST SELLER



Power size 2-4 adjustable by valve
For inward and outward opening doors
For doors up to 80KG and up to 1100mm in width
Adjustable closing force, closing speed and latching action
Certifire rated
Tested to 1634-1: 2-hour timber doors and 4-hour steel fire doors
Tested to BS EN 1154
Finish: Silver

Product code: 510006

BRITON OVERHEAD DOOR CLOSER: HEAVY DUTY



Power size 1-4 adjustable by valve
For inward and outward opening doors
Suitable for doors up to 1100mm width and 80Kg in weight
Adjustable latch action, closing action and backcheck
Tested to BS EN 1634-1: 2-hour timber fire doors and 4-hour steel fire doors
Certifire rated
Tested to BS EN 1154
Capable of meeting the low opening forces required to meet BS 8300:2001
Finish: Silver

Product code: 510008

DORMA OVERHEAD DOOR CLOSER: HEAVY DUTY



Power size 2-5 adjustable by valve
For inward and outward opening doors
To suit doors up to 100kg and 1250mm in width
Adjustable power, "thinking" backcheck and delayed action
Tested to BS EN 1634-1: 2-hour timber fire doors and 4-hour steel fire doors
Certifire rated
Tested to BS EN 1154
Finish: Silver

Product code: 510007

ELECTRO-MAGNETIC DOOR CLOSER



Power size 4
For inward and outward opening doors
Suitable for doors up to 80Kg and 1100mm in width
Adjustable latching and sweep speed
Hold open and swing free functions
2-year guarantee
Tested to BS EN 1634-1: 2-hour timber fire doors and 4-hour metal fire doors
Certifire rated
Tested to BS EN 1155
Finish: Silver

Product code: 510015

DORMA FLOOR SPRING



Power size 1 - 4
Universally handed
Suitable for doors up to 120Kg and 1100mm in width
Adjustable closing force, mechanical backcheck and hold open at 90 and 105 degrees
Requires either a double action or single action accessory pack to operate
Tested to BS EN 1634-1: 1-hour timber fire doors and 4-hour metal fire doors
Tested to BS EN 1154

Product code: 006921

DORGARD

BEST SELLER



Holds open fire doors, allowing them to close automatically on the sound of a fire alarm
Installed at the bottom of a door in under 5 minutes
Listens for a continuous alarm for 14 seconds
Adheres to
BS EN 61000-6-3:2007
BS EN 50130-4:2011
BS EN 1155:1997
BS EN 1634-1:2008

Product code: 510016

DOUBLE ACTION FLOOR SPRING KIT



Complete with arms and cover plate
Allows door to swing in both directions
Finish: SSS

Product code: 006397

SINGLE ACTION FLOOR SPRING KIT



Includes arms and cover plate
Allows door to swing in one direction
Finish: SSS

Product code: 006194

DOOR SELECTOR



Finish: SAA
Ensures correct door closing sequence
To suit rebated double doors
Designed to be fitted to the first opening leaf
Adheres to BS EN 1158
Suits timber doors up to 1220mm width

Product code: 510014

SURFACE LIMITING STAY



Finish: Matt silver
Limits opening angle of door/window to 90 degrees
FD30/60 rated

Product code: 008822



DOOR CONTROLS

POWERMATIC CONCEALED DOOR CLOSER

Power size 3

Suitable for doors up to 80Kg and 950mm in width

Adjustable closing speed and power latching action

Can be used with electronically powered hold open devices

10-year guarantee

Certifire rated

Tested to BS EN 1634-1:
1-hour and 30-minute
timber fire doors

Tested to BS EN 1154

Contributes to achievement
of BS 8300: 2009

Finishes available:

SC: 006898

PB: 006879

SSS: 006898

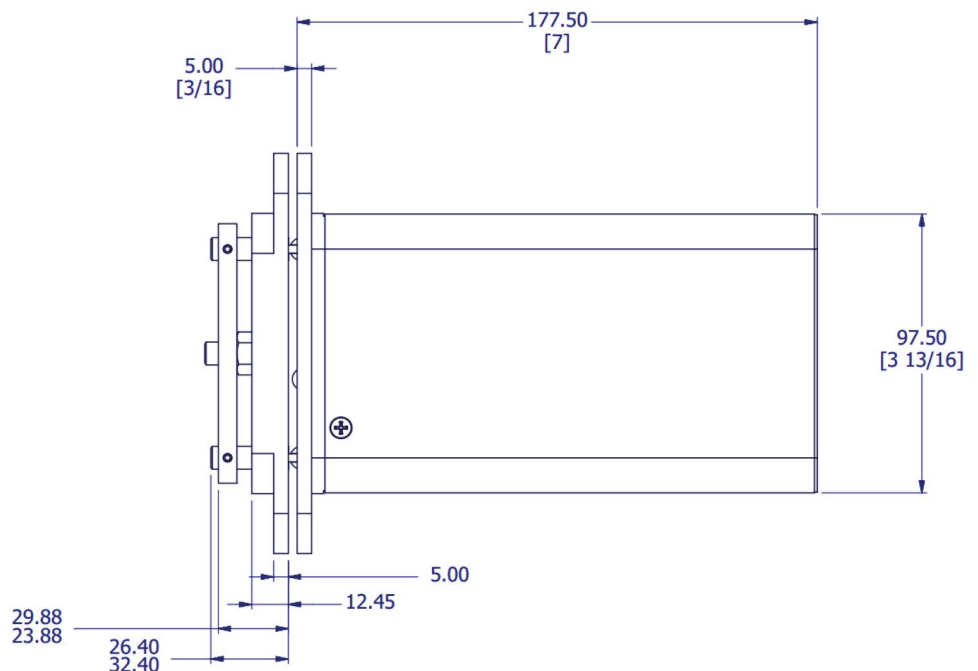
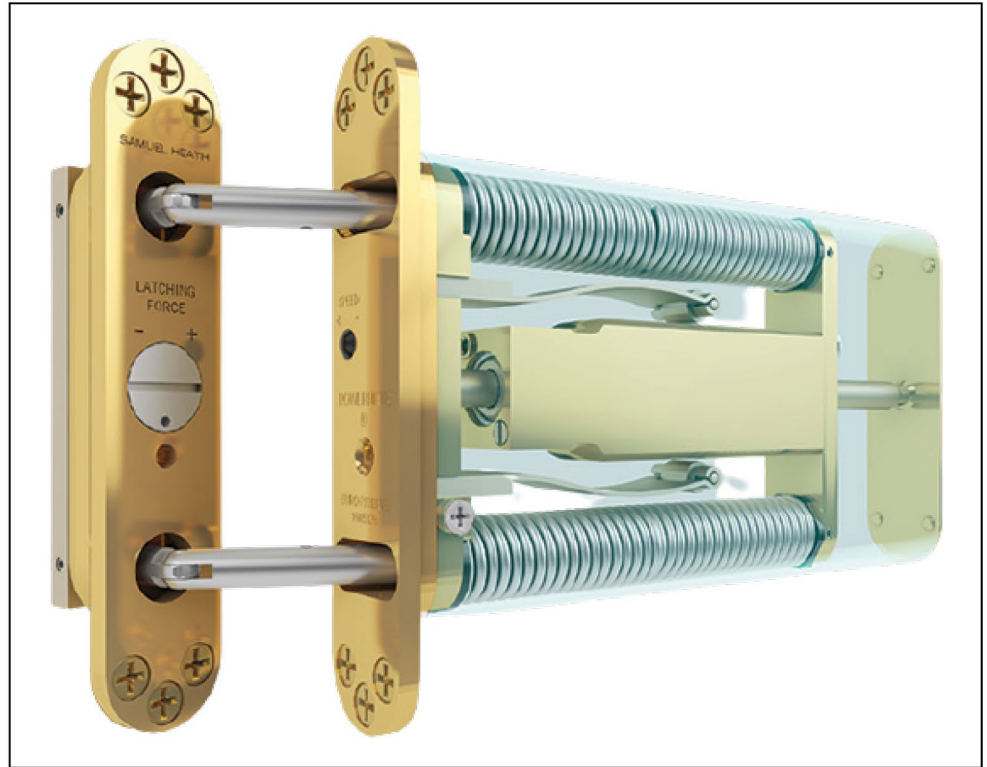

ARCHITECTURAL IRONMONGERY

DOOR HANDLES



DOOR HANDLES

ARCHITECTURAL LEVER ON ROSE - SSS

BEST SELLER

Finish: SSS
 Sold as a pair
 Rose diameter: 52mm
 Handle thickness: 19mm
 Sprung
 Grade 304 satin stainless
 Supplied with screws & back to back fixings
 Suitable for FD30 & FD60 doors
 Complies to the design requirements of BS8300
 Tested to BS EN 1906 Grade 3
 10 year mechanical guarantee



Product code: 550000

ARCHITECTURAL LEVER ON ROSE - SAA

Finish: SAA
 Sold as a pair
 Rose diameter: 52mm
 Handle thickness: 19mm
 Sprung rose
 Supplied with screws & back to back fixings
 Suitable for FD30 & FD60 doors
 Complies to the design requirements of BS8300
 Tested to BS EN 1906 Grade 3
 10 year mechanical guarantee



Product code: 550007

CONTRACT LEVER ON ROSE - SAA

Finish: SAA
 Sold as a pair
 Rose diameter: 52mm
 Handle thickness: 19mm
 Sprung rose with push on cover
 Supplied with screws & back to back fixings
 Complies to the design requirements of BS8300
 Tested to BS EN 1634-1
 10 year mechanical guarantee

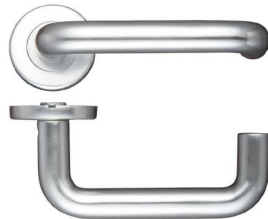

Product code: 550053

FACILITY INDICATOR LOCK

Grade 304 satin stainless steel
 Reversible handing
 Supplied with keeps for both hinged & sliding door
 Suitable for FD30 & FD60 doors
 Complies to the design requirements of BS8300
 10 year mechanical guarantee



Product code: 520050

'RADAR' NATIONAL KEY SYSTEM LOCK

Lever operated
 Often used to access facilities reserved for less able customers
 Can be operated by all NKS (RADAR) Keys
 Set includes a mortice lock, key, strike plate & handle set
 Complete with fixing screws & bolts



Product code: 520061 * Extra Keys with large head - 001988

ARCHITECTURAL IRONMONGERY



DOOR HANDLES

We Cut Keys!

DOOR HANDLES

CONTRACT LEVER ON BACKPLATE - SAA



Finish: SAA
Sold as a pair
Supplied with screws
Tested to BS EN 1634-1

Product code:	Type:	Size (mm):
550042	Latch	102 x 40
550043	Euro Profile	154 x 40
550044	Bathroom Privacy	154 x 40
550045	Standard Keyway	154 x 40
550260	Oval Profile	154 x 40

ARCHITECTURAL LEVER ON BACKPLATE



Thickness of lever: 19mm
Sprung
Push on covers
Sold as a pair
Supplied with screws
Suitable for FD30 & FD60 doors
Complies to the design requirements of BS8300
Tested to BS EN 1906 Grade 3
10 Year mechanical guarantee
Grade 304 SSS

Product code:	Type:	Size (mm)	Finish:
550014	Latch	180 x 45	SSS
550015	Euro Profile	180 x 45	SSS
550017	Bathroom Turn & Release	180 x 45	SSS
550019	Standard Keyway	180 x 45	SSS
550020	Oval Profile	180 x 45	SSS
550016	Euro DIN lock	180 x 45	SSS
550018	Bathroom DIN lock	180 x 45	SSS
550021	Latch	178 x 44	SAA
550022	Euro Profile	178 x 44	SAA
550023	Bathroom Turn & Release	178 x 44	SAA
550024	Standard Keyway	178 x 44	SAA
550025	Oval Profile	178 x 44	SAA
550259	Euro DIN lock	178 x 44	SAA
550258	Bathroom DIN lock	178 x 44	SAA

COMMERCIAL ESCUTCHEONS & TURNS



Push on rose

Product code:	Type:	Size (mm)	Finish:
550004	Blank	52 x 8	SSS
550001	Euro profile	52 x 8	SSS
550002	Standard keyway	52 x 8	SSS
550003	Oval profile	52 x 8	SSS
550005	Turn & indicator release	52 x 8	SSS
550006	Large Turn & indicator release	52 x 8	SSS
550011	Blank	52 x 8	SAA
550008	Euro profile	52 x 8	SAA
550009	Standard keyway	52 x 8	SAA
550010	Oval profile	52 x 8	SAA
550054	Turn & indicator release	52 x 8	SAA
550013	Large turn & indicator release	52 x 8	SAA

ARCHITECTURAL IRONMONGERY

DOOR HANDLES



DOOR HANDLES

DOMESTIC BRASS LEVERS ON BACKPLATE

Finish: Dual finish

Sold as a pair

Backplate size: 180 x 48mm

Supplied with woodscrews

10- year mechanical guarantee

BS EN 1634-1



Product code:	Type:	Finish:
550106	Euro Profile	Satin Brass/Polished Brass
550107	Euro Profile	Satin Chrome/Polished Chrome
550108	Standard Keyway	Satin Brass/Polished Brass
550109	Standard Keyway	Satin Chrome/Polished Chrome
550110	Latch	Satin Brass/Polished Brass
550111	Latch	Satin Chrome/Polished Chrome
550112	Bathroom	Satin Brass/Polished Brass
550113	Bathroom	Satin Chrome/Polished Chrome

VICTORIAN LEVER HANDLES

Sold as a pair



Product code:	Type:	Finish:
003614	Lock	Brass
003615	Latch	Brass
003616	Bathroom	Brass
003617	Privacy	Brass
003724	Lock	Chrome
003725	Latch	Chrome
003726	Bathroom	Chrome
003727	Euro lock	Chrome

ARCHITECTURAL IRONMONGERY

DOOR HANDLES



DOOR HANDLES

VICTORIAN SCROLL LEVER HANDLES

VICTORIAN SCROLL LEVER HANDLES			
Sold as a pair	Product code:	Type:	Finish:
	003618	Lock	Brass
	003619	Latch	Brass
	003620	Bathroom	Brass
	003621	Privacy	Brass
	003720	Lock	Chrome
	003721	Latch	Chrome
	003722	Bathroom	Chrome
	003723	Privacy	Chrome

	VICTORIAN OVAL MORTICE KNOBSET	Size: 65mm Sold as a pair	Finish:	Product code:
			Brass	003625
			Polished chrome	003730

	VICTORIAN CENTRE DOOR KNOB	Size: 75mm Sold individually	Finish:	Product code:
			Brass	003640
			Polished chrome	003728

	VICTORIAN ROUND MORTICE KNOBSET	Size: 60mm Sold as a pair	Finish:	Product code:
			Brass	003622
			Polished chrome	003729





	PLASTIC MORTICE KNOBSET	Size: 60mm	Colour:	Product code:
			White	003799
			Brown	003800

ARCHITECTURAL IRONMONGERY

DOOR HANDLES



DOOR HANDLES

	GEORGIAN MORTICE KNOBSET	Size: 65mm Sold as a pair	Product code: 003599
	ANTIQUE SPRUNG MORTICE KNOBSET	Sold as a pair Size: 55mm	Product code: 003812
	ANTIQUE CENTRE DOOR KNOB	Sold individually Size: 63mm	Product code: 003813
	VICTORIAN RIM KNOBSET	Size: 50mm Finish: Brass	Product code: 003626

PASSAGE KNOBSETS

Product code:	Knobset type:	Backset (mm)	Finish:
009883	Entrance	60 / 70	Brass
003742	Privacy	60 / 70	Brass
003743	Passage	60 / 70	Brass
003744	Entrance	60 / 70	SSS
003745	Privacy	60 / 70	SSS
003746	Passage	60 / 70	SSS



	FLEUR DE LYS HANDLES	Sold as a pair Size: 190mm	Types in stock:	Products code:
			Lever latch	003808
			Lever lock	003807

ARCHITECTURAL IRONMONGERY



DOOR HANDLES

We Cut Keys!

ZOO
ARCHITECTURAL HARDWARE







DOOR HANDLES

	GEORGIAN LEVER HANDLES	Sold as a pair	Types in stock:	Product code:
			Lever lock	003595
			Lever latch	003596
			Bathroom	003597
			Privacy	003598
	ANTIQUE LEVER HANDLES	Sold as a pair Backplate height: 150mm	Types in stock:	Product code:
			Lever latch	003811
			Lever lock	003809
			Bathroom	003810
	TAYLOR SPINDLE	For face fixing lever or knob into position	Product code: 550295	

DOMESTIC LEVERS ON ROSE

Rose diameter: 50mm
Rose thickness: 8mm
Sold as a pair
Screw-on outer rose

Supplied with screws & back to back fixings
Suitable for use on FD30 & FD60 doors
Tested to BS EN 1634-1

		
Finish: Polished chrome	Finish: Satin chrome	Finish: Satin chrome
Product code: 550081	Product code: 550084	Product code: 550088
		
Finish: Satin chrome	Finish: Polished chrome/Black aluminium	Finish: Polished chrome
Product code: 550082	Product code: 550085	Product code: 550089

ARCHITECTURAL IRONMONGERY

DOOR HANDLES



DOOR HANDLES



Finish: Polished chrome

Product code: 550083



Finish: Polished chrome/SSS

Product code: 550086



Finish: Satin chrome

Product code: 550090



Finish: Polished chrome

Product code: 550087



Finish: Polished chrome

Product code: 550091



Finish: Polished chrome

Product code: 550105



Finish: Satin chrome

Product code: 550092



Finish: Polished chrome

Product code: 550097



Finish: Polished chrome/SSS

Product code: 550101



Finish: Satin chrome/Polished chrome

Product code: 550093

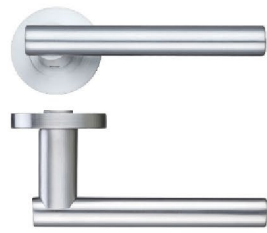

Finish: Satin chrome

Product code: 550098



Finish: Satin chrome/Polished chrome

Product code: 550102

ARCHITECTURAL IRONMONGERY

DOOR HANDLES



DOOR HANDLES



Finish: Satin chrome

Product code: 550095



Finish: Satin chrome/Polished chrome

Product code: 550099



Finish: Satin chrome/Polished chrome

Product code: 550103



Finish: Satin chrome/Polished chrome

Product code: 550096



Finish: Polished chrome/Satin nickel

Product code: 550100



Finish: Polished chrome/SSS

Product code: 550104

DOMESTIC ESCUTCHEONS & TURNS



Product code:	Type:	Finish:
550075	Euro profile escutcheon	PC
550076	Euro profile escutcheon	SC
550077	Standard keyway escutcheon	PC
550078	Standard keyway escutcheon	SC
550079	Turn & release	PC
550080	Turn & release	SC

ARCHITECTURAL IRONMONGERY

DOOR HANDLES



DOOR HANDLES

FIXING PACK

Back to back fixing pack



Product code: 550052

HALF SPINDLES

Allows each side to operate independently

For use with split spindle lock cases with an 8mm follower

Supplied as a pair

Shorter spindle to suit external side



Product code: 550297

SPLIT SPINDLE FOR DIN ESCAPE LOCKS

Size: 120 x 8mm

To suit split follower DIN escape cases with passthrough followers only

Crimped stop on inside/sprung pin on outside



Product code: 550298

SPINDLE - 8MM

Length: 140mm
Sold individually



Product code: 003626

SPINDLE - 5MM

Length: 120mm
Sold individually



Product code: 006395

SPINDLE ADAPTOR SLEEVE

Changes 5mm spindle to 8mm
30mm Long



Product code: 550299

ARCHITECTURAL IRONMONGERY

HINGES



HINGES

BALL BEARING BUTT HINGES

Tested to BS EN 1935
Grade 201 Stainless Steel
Sold in Pairs
500003 & 500006 available in pack of 3 hinges
Suitable for FD30/60 fire doors when fitted
with intumescent hinge pads (590010)

**BEST
SELLER**



Product code:	Leaf height (mm)	Total width (mm)	Knuckle width (mm)	Leaf thickness (mm)	Finish:	Corners:	Grade:
500003	102	76	14.5	3	SSS	S	13
500004	102	76	14.5	3	PSS	S	13
500005	102	76	14.5	3	PVD	S	13
500006	102	76	14.5	3	SSS	R	13
500000	76	50	11.5	2	SSS	S	7
500001	76	50	11.5	2	PSS	S	7
500002	76	50	11.5	2	PVD	S	7

STEEL BUTT HINGES

Zinc plated steel butt hinges
Unsuitable for fire doors
Sold in pairs



Product code:	Leaf height (mm)	Total width (mm)	Leaf thickness (mm)	Finish:	Corners:	Light duty/ Heavy duty:
500025	63	45	2	ZP	S	L
500009	75	50	2	ZP	S	L
500010	100	70	2	ZP	S	L
500011	75	64	3	ZP	S	H
500012	100	75	3	ZP	S	H

ARCHITECTURAL IRONMONGERY

HINGES

FRELAN
HARDWARE

The name of quality
architectural hardware



DOUBLE PRESSED STEEL BUTT HINGES

Sold in pairs
Leaf consists of a double steel layer
Often used in welding applications
Available with or without holes
Unsuitable for fire doors

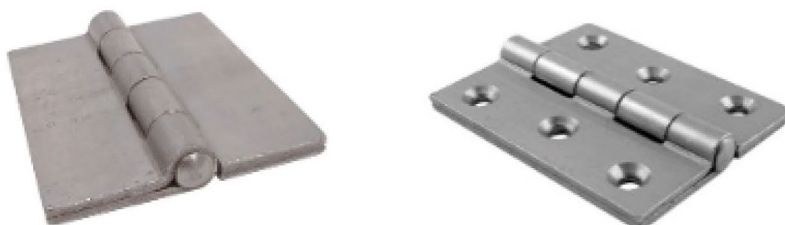

Product code:	Leaf height (mm)	Total width (mm)	Leaf thickness (mm)	Holes:	Finish:	Corners:
500013	100	75	4	Y	ZP	S
500014	100	75	4	N	S/C	S

BRASS BUTT HINGES

Sold in pairs



Product code:	Leaf height (mm)	Finish:	Corner:
003867	25	EB	S
003868	38	EB	S
003869	63	EB	S

RISING HINGES

Rising hinges are held together by a door's weight

They allow doors to self-close and to rise above any obstacles a door may face during its opening cycle

Finish: Zinc plated

Size: 75 x 72mm

Sold in pairs only – pair & half sets NOT to be fitted as it may affect closing cycle



Product code:

Right-handed: 500030

Left-handed: 500029

DOUBLE STAINLESS STEEL WASHERED HINGES

Sold in pairs



Product code:	Leaf height (mm)	Total width (mm)	Leaf thickness (mm)	Finish:	Corners:
500038	76	50	2.5	PB	S
500037	102	67	4	PB	S

SINGLE ACTION SPRING HINGE

Act as door closing devices in situations where an overhead door closer would be unsuitable

Sold in packs of 3

30-minute fire tested

Suitable for doors up to 60Kg

6 adjustable settings

Finish: SC

Dimensions: 102 x 75 x 3mm



Product code:

500032

ARCHITECTURAL IRONMONGERY



We Cut Keys!

HINGES

DOUBLE ACTION SPRING HINGES

Allow doors to swing in both directions
Ideal for commercial kitchens
Sold in pairs

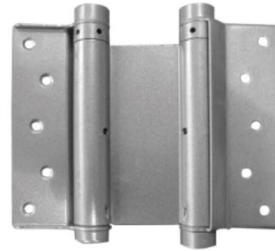

Product code:	Leaf height (mm)	Total hinge width (mm)	Mid-section height (mm)	Mid-section width (mm)	Knuckle thickness (mm)	Door thickness (mm)	Door weight (Kg)	Finish:
500008	150	176	136	48	26	35 - 40	40kg	Silver
500007	100	129	87	35	20	25 - 30	22kg	Silver

FLUSH HINGES

Sold in pairs



Product code:	Leaf height (mm)	Finish:	Corners:
003874	40	EB	S
003875	50	EB	S
006389	60	EB	S
003876	75	EB	S
003877	40	ZP	S
003878	50	ZP	S
003879	60	ZP	S
003880	75	ZP	S

STORM-PROOF HINGES

Sold in pairs
Leaf height: 63mm
Finish: Zinc plated



Product code:
500031

CRANKED FLUSH HINGE

Leaf height: 50mm
Finish: Electro Brass
Sold in pairs



Product code:
006159

ARCHITECTURAL IRONMONGERY

HINGES

FRELAN
HARDWARE

The name of quality
architectural hardware



PARLIAMENT HINGES

Utilised when a door needs to avoid any obstructive door facings

Sold in packs of 3



Product code:	Leaf height (mm)	Total width (mm)	Leaf thickness (mm)	Total central gap (mm)	Finish:
003870	100	130	4	80	PB
003872	100	130	4	80	SC
003871	100	130	4	80	PC

BACKFLAP HINGES

Finish: ZP

Sold in pairs

Total width: 60mm

Leaf height: 25mm



Product code:

003873

COUNTER FLAP HINGES

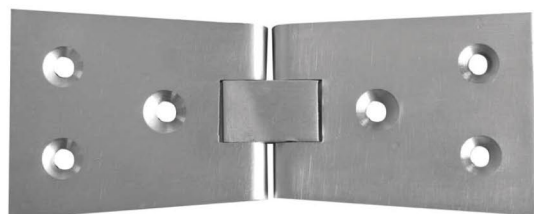

Product code:	Leaf height (mm)	Total width (mm)	Finish
500035	40	100	SC
500033	40	100	PB
500034	40	100	PC

CABINET HINGES

Sold individually

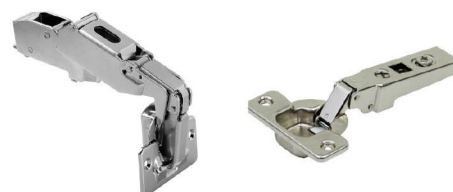

Product code:	Fitting	Opening angle (degrees)
500020	Inset	100
500019	Half overlay	100
500018	Full overlay	100
500022	Half overlay	170
500021	Full overlay	170

MOUNTING PLATE



Sold individually
To suit Mitchells cabinet hinges

Product code: 500023

SOFT CLOSING HINGE



Sold as a pair

Product code: 003882

EASY-ON CABINET HINGE



Length: 105mm
Sold as a pair

Product code: 003881

ARCHITECTURAL IRONMONGERY

HINGES



HINGES

PIANO HINGES

Sold individually
Can be cut to size

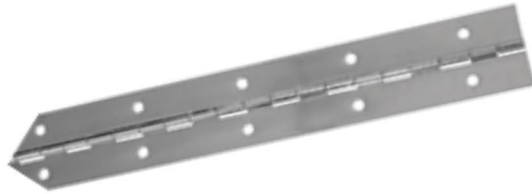

Product code:	Total leaf width (mm)	Total length (mm)	Finish:
500015	32	1830	NP
500016	32	1830	EB
500017	35	1830	SS

HINGE REPAIR PLATE



Sold in pairs

Product code: 500024

DOUBLE ACTION PIVOT HINGE SET

Grade 304 stainless steel
Designed to allow door to open outwards in case of emergency
Maximum door weight: 80Kg
For use with 500028 emergency release door stop



Product code: 500027

PIVOT EMERGENCY RELEASE DOOR STOP

Grade 304 stainless steel
Designed to allow the door to open outwards in case of emergency
For use with 500027 square pivot hinge set
Maximum door weight: 80Kg



Product code: 500028

STEEL HINGE BOLTS



Finish: Zinc plated
Sold in pairs

Product code: 003452

ANTIQUE DUMMY HINGES



Size: 400mm
Sold as a pair

Product code: 003818

CABINET HINGE DAMPENER



Sold as a pair

Product code: 003901

HEAVY ANTIQUE HINGES



Size: 300mm
Sold as a pair

Product code: 003816

ANTIQUE HINGES



Size: 290mm
Sold as a pair

Product code: 003817

SMALL ANTIQUE HINGES



Size: 100mm
Sold as a pair

Product code: 003824

ARCHITECTURAL IRONMONGERY

LOCKS



EURO PROFILE DOUBLE CYLINDERS

Tested to BS EN 1303
30/60-minute fire door rated
Anti-drill
Anti-pick
Break off system



EURO PROFILE OFFSET DOUBLE CYLINDERS

Tested to BS EN 1303
30/60-minute fire door rated
Anti-drill
Anti-pick
Break off system

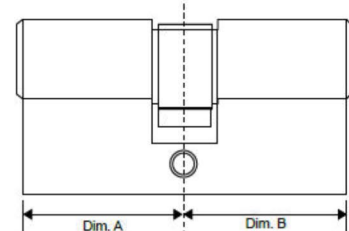

Product code:	Total Length (mm)	Finish:	Thumb turn:
530000	60	SC	No
530001	70	SC	No
530002	80	SC	No
530003	90	SC	No
530004	100	SC	No
530005	60	SC	Yes
530006	70	SC	Yes
530007	80	SC	Yes
530008	90	SC	Yes
530009	100	SC	Yes

Product Code:	Length A (mm)	Length B (mm)	Finish	Thumb turn
530011	30	40	SC	No
530012	30	50	SC	No
530013	30	70	SC	No
530014	35	40	SC	No
530015	35	45	SC	No
530016	35	50	SC	No
530017	35	55	SC	No
530018	40	45	SC	No
530019	40	50	SC	No
530020	40	55	SC	No
530021	40	60	SC	No
530022	45	50	SC	No
530023	45	55	SC	No
530024	30	50T	SC	Yes
530025	30	70T	SC	Yes
530026	35	40T	SC	Yes
530027	35	45T	SC	Yes
530028	35	55T	SC	Yes
530029	40	35T	SC	Yes
530030	40	45T	SC	Yes
530031	40	50T	SC	Yes
530032	40	60T	SC	Yes
530033	45	35T	SC	Yes
530034	45	40T	SC	Yes
530035	50	30T	SC	Yes
530036	50	40T	SC	Yes
530037	60	40T	SC	Yes
530038	70	30T	SC	Yes

KEYED ALIKE CYLINDERS

Tested to BS EN 1303
30/60-minute fire door rated
Anti-drill
Anti-pick
Break off system
All sizes and types available on special order



Product code:	Type:	Size (mm)	Finish:
008765	Euro double	70	SC
008923	Euro cylinder and turn	70	SC
008364	Euro single	45	SC

ARCHITECTURAL IRONMONGERY



LOCKS

MASTER KEYED CYLINDERS

Tested to BS EN 1303
30/60-minute fire door rated
Anti-drill
Anti-pick
Break off system
All sizes and types available on special order



RIM CYLINDER

Tested to BS EN 1303
Break off system



Product codes: SC: 530043 PB: 530042

SCREW-IN CYLINDER SET

Supplied complete with trim rings
Fitted with rear cam for use with mortice type metal door locks
Supplied in keyed-alike pairs complete with 3 keys
Single cylinders also available to special order



Product Code: 530046

Product code:	Type:	Size (mm)	Finish:
008833	Euro double	70	SC
008378	Euro cylinder and turn	70	SC
008912	Euro single	45	SC

DIN STANDARD LOCKS

Tested to BS EN 12209 2003: Grade 3
Larger distance between the spindle and the lock mechanism to increase user comfort
Finish: SSS
'Grip tight' follower
Anti-rattle strike
Bathroom lock contains an 8mm-5mm spindle adaptor
Escape locks allow a door to be unlocked from the inside by a single motion of the door furniture, without the need to turn a bolt
Suitable for 30/60-minute fire doors



Product code:	Lock type:	Backset (mm)	Spindle to lock (mm)	Case width (mm)	Case height (mm)	Forend Type:
520000	Latch	60	-	90	165	S
520075	Latch	60	-	90	165	R
520003	Deadlock	60	-	90	165	S
520074	Deadlock	60	-	90	165	R
520001	Sashlock	60	72	90	165	S
520072	Sashlock	60	72	90	165	R
520004	Escape sashlock	60	72	90	165	S
520076	Escape sashlock	60	72	90	165	R
520002	Bathroom lock	60	78	90	165	S
520073	Bathroom lock	60	78	90	165	R

ARCHITECTURAL IRONMONGERY

LOCKS



BULLET LOCK

To suit the most popular size of roller shutters

Keyed alike

Body length: 35mm

Pin length: 55mm

Profile dimensions: 22 x 15mm



Product Code: 530044

HOUSING FOR BULLET LOCK



Product Code: 530045

UK STANDARD LOCKS

Tested to BS EN 12209:2003 Grade 2
Solid Brass latch and deadbolt
Sintered steel follower
Short travel latch function
Grip tight spring follower
Includes plastic back box
Suitable for 30/60-minute fire doors



Product code:	Lock type:	Backset (mm)	Case width (mm)	Case height (mm)	Spindle to lock (mm)	Finish:
520006	Euro sashlock	44.5	67.5	112	47.5	SSS
520091	Euro sashlock	44.5	67.5	112	47.5	PVD
520007	Euro sashlock	57	79.5	112	47.5	SSS
520092	Euro sashlock	57	79.5	112	47.5	PVD
520008	Euro deadlock	44.5	67.5	80	-	SSS
520093	Euro deadlock	44.5	67.5	80	-	PVD
520009	Euro deadlock	57	79.5	80	-	SSS
008883	Euro deadlock	57	79.5	80	-	PVD
520010	Bathroom lock	44.5	65.5	102	57	SSS
520012	Bathroom lock	44.5	65.5	102	57	PVD
520011	Bathroom lock	57	78	102	57	SSS
520013	Bathroom lock	57	78	102	57	PVD
520014	Oval sashlock	44.5	67.5	112	47.5	SSS
520095	Oval sashlock	44.5	67.5	112	47.5	PVD
520015	Oval sashlock	57	79.5	112	47.5	SSS
520096	Oval sashlock	57	79.5	11.2	47.5	PVD
520016	Oval deadlock	44.5	67.5	80	-	SSS
520097	Oval deadlock	44.5	67.5	80	-	PVD
520017	Oval deadlock	57	79.5	80	-	SSS
520098	Oval deadlock	57	79.5	80	-	PVD
520020	3 lever sashlock	44.5	65.5	102	57	SSS
520022	3 lever sashlock	44.5	65.5	102	57	PVD
520021	3 lever sashlock	57	78	102	57	SSS
520023	3 lever sashlock	57	78	102	57	PVD
520024	3 lever deadlock	44.5	65.5	72	-	NP
520026	3 lever deadlock	44.5	65.5	72	-	PB
520025	3 lever deadlock	57	78	72	-	NP
520027	3 lever deadlock	57	78	72	-	PB



We Cut Keys!

LOCKS

BRITISH STANDARD 5 LEVER LOCKS

BEST SELLER

Complies with BS 3621:2007

Meets the demands of insurance companies and the police

5 lever mechanism

The deadbolt has hardened steel plates to resist drilling and saw attack

Supplied with 2 keys



Product code:	Lock type:	Backset (mm)	Spindle to lock (mm)	Case width (mm)	Case height (mm)	Finish:
520028	Sashlock	44.5	47.5	67.5	110	SC
520029	Sashlock	57	47.5	79.5	110	SC
520032	Deadlock	44.5	-	67.5	90	SC
520033	Deadlock	57	-	79.5	90	SC
520030	Sashlock	44.5	47.5	67.5	110	PB
520031	Sashlock	57	47.5	79.5	110	PB
520034	Deadlock	44.5	-	67.5	90	PB
520035	Deadlock	57	-	79.5	90	PB

UNION MORTICE LOCKS

3 lever locks

Reversible latch bolts

Pierced to accept bolt through furniture (except 50mm sash lock case)

Suitable for use with unsprung lever handles (except 50mm sash lock case)

10 year Guarantee

Tested to BS EN 1634-1

Supplied with 2 Keys



Product code:	Lock type:	Backset (mm)	Case width (mm)	Case height (mm)	Spindle to lock (mm)	Finish:
520054	Sashlock	32	56	109	57	SC
520055	Sashlock	44.5	65	109	57	SC
520056	Sashlock	57	78	109	57	SC
520057	Deadlock	44.5	65	70	-	SC
520058	Deadlock	57	80	70	-	SC

ARCHITECTURAL IRONMONGERY

LOCKS



	<h3>REBATED SASHLOCK</h3>	<p>2 lever lock Reversible latch bolt To suit 13mm rebated wooden doors Universally handed 5 year Guarantee Tested to BS EN 1634-1 Finish: SE Supplied with 2 Keys Backset sizes in stock:</p>	<p>Product code: 44.5mm: 520059 57mm: 520060</p>
	<h3>ASSA ESCAPE NIGHTLATCH</h3>	<p>Suitable for entrance and exit doors which must lock automatically when the door is closed. The lever handle gives fast, safe exit in an emergency. These locks are also ideal for use with electric strikes in access control applications</p> <p>Uses either Euro or UK Oval profile cylinders</p> <p>Supplied as standard with security box striking plate and square faceplate</p> <p>Hardened steel 13mm latchbolt deadlocks automatically when door is closed</p> <p>Latchbolt reversible without opening lock case</p> <p>Available with 57mm backset</p>	<p>Product code: 520077</p>
	<h3>ASSA COMPACT ESCAPE SASH LOCK</h3>	<p>Escape sash locks are ideal for residential entrance doors, and comply with BS 5588 Part 1, section 1882 (a) Their simple operation makes them ideal for use by the elderly</p> <p>Uses either Euro or UK Oval profile cylinders</p> <p>Supplied as standard with security box striking plate and square faceplate</p> <p>Hardened steel deadbolt thrown 16mm by internal lever handle or by 360° turn of key. Latch bolt reversible without opening lock case</p> <p>Available with 57mm backset</p> <p>Lock case must be used with a double action handle eg ASSA 3350</p>	<p>Product code: Right hand: 520078 Left hand: 520079</p>
	<h3>ASSA SASH LOCK WITH HOOK BOLT</h3>	<p>Lock case for classrooms, hotels, technical areas, offices, etc where high security demands and quick and convenient exiting are top priorities</p> <p>Features 50mm backset</p> <p>Complies with the requirements of Swedish Standard SS 3522, class 2</p> <p>With deadlocking lever latch and hook bolt</p> <p>Latch bolt deadlocks automatically when it is extracted 14mm and the deadlocking latch is depressed</p> <p>Handing of the lever latch is reversible</p> <p>Can be fitted with or without outside handle</p> <p>Options in stock:</p>	<p>Product code: Right hand: 520080 Left hand: 520081</p> <p>Outside: Deadbolt is operated with key Latch is retracted with handle</p> <p>Inside: Deadbolt is operated with thumb turn Latch and deadbolt are retracted with the lever handle</p>

ARCHITECTURAL IRONMONGERY



LOCKS

REBATE KITS

Rebate kits allow locking mechanisms to be fitted correctly on rebated double doors

They are brand specific, therefore a rebate kit for a specific lock will not necessarily work with a different lock. The rebate kits we supply suit the locks we also supply



Product code:	Suitable locks	Rebate size (mm)	Finish:
520018	UK standard sashlocks	13	SSS
520019	UK standard deadlocks	13	SSS
520005	DIN standard locks	13	SSS
520036	BS 5 lever sashlocks	13	SC
520037	BS 5 lever sashlocks	13	PB
520038	BS 5 lever deadlocks	13	SC
520039	BS 5 lever deadlocks	13	PB
520082	Union 3L deadlocks	13	SC
520083	Union 3L sashlocks	13	SC

STANDARD TUBULAR LATCH

BEST SELLER

Suitable for commercial and residential use

Bolt through fixings holes to suit lever on rose furniture



Product code:	Backset (mm)	Finish:
520046	45	SZ
520062	45	PB
520047	57	SZ
520063	57	PB

ARCHITECTURAL TUBULAR LATCH



Tested to BS EN 1634-1
Tubular bolt through latch
Guided latch bolt
Adjustable strike
Finish: SSS
Backset sizes in stock:

Product code:
45mm: 520068 57mm: 520069

REBATED TUBULAR LATCH



To suit double doors with rebated meeting edges
Rebate size: 13mm
Finish: SC
Backset sizes in stock:

Product code:
44mm: 520087 57mm: 520088

REBATE KITS TO SUIT TUBULAR LATCHES



To suit double doors with rebated meeting edges
Rebate size: 13mm
To suit our standard tubular latch range
Finishes in stock:

Product code:
SC: 520065 PB: 520064

ARCHITECTURAL IRONMONGERY

LOCKS



BRASS FACEPLATE FOR ARCHITECTURAL TUBULAR LATCH



Product code: 520084

RADIUS ACCESSORY PACK FOR ARCHITECTURAL TUBULAR LATCH



Product code:
SS: 520085 PVD: 520099

UNION EXTENDED TUBULAR LATCH



Finish: SE
Backset: 71.5mm
Total length: 91.5mm

Product code: 520086

UNION TUBULAR LATCH REBATE KIT



Rebate size: 13mm
To suit Union tubular latches & digital locks
Finish: SC

Product code: 520089

ARCHITECTURAL TUBULAR DEAD BOLT



Standalone deadbolt for locking doors
Finish: SSS
Tested to BS EN: 1634-1
Backset sizes in stock:

Product code:
44mm: 520070 57mm: 520071

BRASS COVER PLATES



To suit architectural tubular deadbolt

Product code: 520090

EXTENDED STRIKE PLATE

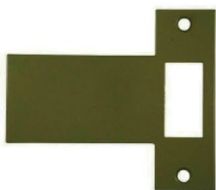

Total length: 100mm

Product code: 009636

ADJUSTABLE ROLLER BOLT CATCHES

Suitable for push/pull doors

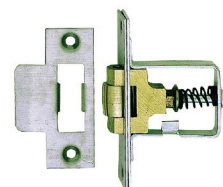

Product code:

Size (mm)

Finish:

570029

59 x 25

SN

570030

59 x 25

PB

570031

45 x 32

SSS

570032

45 x 32

SB

ARCHITECTURAL IRONMONGERY



LOCKS

FLAT LATCH					
Finish: SSS 	Product code	Backset (mm)	Case width (mm)	Case height (mm)	Forend length (mm)
	520066	44.5	67.5	60	125
	520067	57	79.5	60	125

RIM NIGHTLATCH				
Non-deadlocking nightlatch Bolt can be locked from inside with snib Supplied with 5-pin cylinder and 3 keys Suitable for timber doors 35-55mm thick 	Product code:	Finish:	Backset (mm)	Case Size (mm)
	520040	SCP	40	62 x 70
	520041	Electro-Brass	40	62 x 70
	520042	SCP	60	92 x 70
	520043	Electro Brass	60	92 x 70

STANDARD NIGHTLATCH
 <p>Finish: Champagne Sizes in stock:</p>
<p>Product code: 40mm: 003586 60mm: 003585</p>

STANDARD NIGHTLATCH
 <p>Finish: Polished chrome Size: 60mm</p>
<p>Product code: 003587</p>

UNION MORTICE NIGHTLATCH
 <p>Reversible latch bolt Accepts UK Oval single cylinder (supplied separately) Case width's in stock:</p>
<p>Product code: 64mm: 520051 76mm: 520052</p>

OPERATING KNOB
 <p>To suit Union mortice nightlatch</p>
<p>Product code: 520053</p>

ARCHITECTURAL IRONMONGERY

LOCKS



DOUBLE LOCKING NIGHTLATCH



Product code:	Finish:	Backset (mm)
003579	PB	60
003580	PB	40
003577	PC	60
003578	PC	40
003581	Silver	60
003582	Silver	40
003583	White	60
003584	White	40

PRESS LOCK



Size: 75mm

Product code: 003592

RIM LATCH WITH SNIB



Size: 100mm

Product code: 003593

DOUBLE HANDED RIM LOCK



Size: 140mm

Product code: 003590

DOUBLE HANDED RIM LOCK - WITH FLANGE



Size: 150mm
Finishes in stock:

Black: 003589
PB: 003588 PC: 003594

DOUBLE HANDED RIM DEADLOCK



Size: 100mm

Product code: 003591

DOUBLE HANDED RIM LOCK



Size: 100mm
Finish: Brass

Product code: 003449

ARCHITECTURAL IRONMONGERY



We Cut Keys!

LOCKS

CAMLOCK

Nut fixed
Supplied with 2 keys
180 degree clockwise movement
5-pin mechanism
Rose diameter: 22.5mm
Body height 18mm
Cam bar 35mm

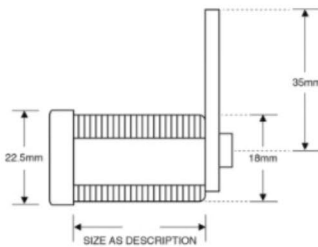

Product code:	Keying type:	Body length (mm)
520100	To Differ	16
520101	Keyed Alike	16
520102	To Differ	20
520103	Keyed Alike	20
520104	To Differ	22
520105	Keyed Alike	22
520106	To Differ	27
520107	Keyed Alike	27
520108	To Differ	32
520109	Keyed Alike	32

DRAWER/CABINET LOCK - TWIN FIXING BACKPLATE

Pedestal lock for drawers/cabinets
180 degree lock/unlock
Supplied with 2 keys



Product code: 520110

DRAWER/CABINET LOCK - SINGLE FIXING BACKPLATE

Pedestal lock for drawers/cabinets
180 degree lock/unlock
Supplied with 2 keys



Product code: 520111

FURNITURE LOCK



Furniture lock for wooden furniture
Supplied with 2 keys
Body diameter: 38mm
Cylinder diameter: 16.3mm
Cylinder length: 19mm

Product code: 520112

DRAWER LOCK



Size: 63mm
Finish: Brass
2 keys included

Product code: 003575

CUPBOARD LOCK



Size: 63mm
Finish: Brass
2 keys included

Product code: 003574

ARCHITECTURAL IRONMONGERY

LOCKS



BEST SELLER		<h3>STANDARD DIGITAL LOCK</h3>	<p>1000+ combinations Internal and external applications Simple installation Optional hold-back Suitable for 35-60mm thick doors Supplied with tubular latch and fittings Finish: SC</p>	<p>Product code: 520045</p>
-------------	---	--------------------------------	--	---

	<h3>PREMIUM DIGITAL LOCK</h3>	<p>Reversible latch Optional hold-back Fire rated when fitted with suitable intumescent packing Protective clutch mechanism Suits 35 - 65mm thick doors Weather resistant PVD Supplied with mortice latch and fittings Finish: SSS</p>	<p>Product code: 520044</p>
--	-------------------------------	--	---

	<h3>RIM BUDGET LOCK</h3>	<p>Can be used for securing panels, meter cupboards, store cupboards, lamp post panels and other applications Locking device for securing doors where high security is not required Can also be used in multiple quantities for securing all types of doors Finish: BZP T-Key required for opening Dimensions: 80 x 20mm</p>	<p>Product code: 540027</p>
---	--------------------------	--	---

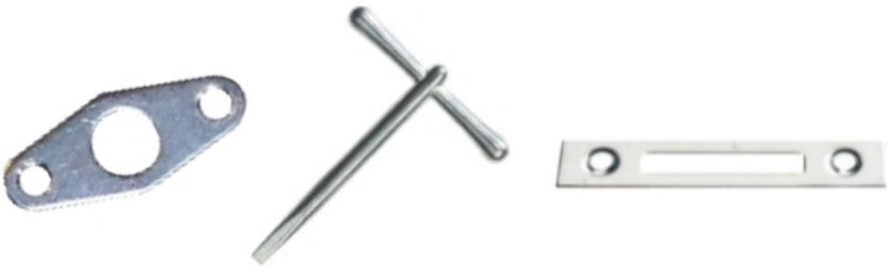
BUDGET LOCK ACCESSORIES		
		
Product code:	Description:	Finish:
540028	T-Key	BZP
540029	Slotted flat keep plate	BZP
540030	Escutcheon plate	BZP

DORMAKABA DIGITAL LOCK

<p>Reversible latch Non-handed unit Protective clutch mechanism Fast code change whilst unit fitted Suits doors 35 - 57mm thick Adjustable backset Weather resistant Finish: SC</p>
<p>Product code: 008146</p>

ARCHITECTURAL IRONMONGERY

PANIC HARDWARE



PANIC HARDWARE

REVERSIBLE PANIC LATCH



Tested to BS EN: 1255
Universally handed
Surface mounted
Adapter supplied for operating with a rim cylinder
Certifire rated
Finish: Silver

Product code: 560002

REVERSIBLE PANIC BOLT



Tested to BS EN: 1255
Universally handed
Surface mounted
Adapter supplied for operating with a rim cylinder
Certifire rated
Finish: Silver

Product code: 560001

REBATED DOUBLE DOOR ESCAPE SET



Tested to BS EN: 1255
Universally handed
Surface mounted
Adapter supplied for operating with a rim cylinder
Certifire rated
Finish: Silver

Product code: 560000

REVERSIBLE PUSH PAD PANIC LATCH



Tested to BS EN: 1255
Universally handed
Surface mounted
Adapter supplied for operating with a rim cylinder
Certifire rated
Finish: Silver

Product code: 560003

LEVER OPERATED OUTSIDE ACCESS DEVICE

Universally handed
Meets the dimensional
requirements of BS 8300
and approved Document M

Lever is supplied with
special shear screw designed
to break under excessive force

Surface mounted on the
outside of the door using
three concealed machine screws

Same fixing points as the knob operated
OAD - easy retro fit

Supplied as standard for doors up to 55mm thick

Longer spindles available on request for door
thicknesses over 55mm

Finish: Silver



Product code: 560004

KNOB OPERATED OUTSIDE ACCESS DEVICE

Universally handed

Fire rated for use on
timber and steel doors

Surface mounted on the
outside of the door using
concealed machine screws

Supplied as standard for
doors up to 45mm thick

Longer spindles and screws
are available on request for
door thicknesses over 45mm

Finish: Silver



Product code: 560005

REDLAM BREAK GLASS BOLT

Designed to produce no sharp
edges when smashed
Breaking the Ceramtube results
in the bolt sliding back automatically
and unlocking the door

Designed for interconnecting
emergency exit doors

Supplied complete with
hammer and chain



Product code: 560007
Extra ceramic tubes available: 560008

DOUBLE DOOR STRIKE PLATE



For use on panic hardware for double rebated doors

Product code: 008887

ARCHITECTURAL IRONMONGERY

IRONMONGERY ACCESSORIES

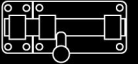

IRONMONGERY
ACCESSORIES

STANDARD DOOR BOLT

	Product code:	Size (mm)	Finish:
	003537	38	PB
003538	50	PB	
003539	63	PB	
003540	75	PB	
003541	100	PB	
003542	150	PB	
003546	38	PC	
003547	50	PC	
003548	63	PC	
003549	75	PC	
003550	100	PC	
003551	150	PC	
003556	38	SAA	
003557	50	SAA	
003558	63	SAA	
003559	75	SAA	
003560	100	SAA	
003561	150	SAA	

HEAVY DOOR BOLT

	Product code:	Size (mm)	Finish:
	003534	100	PB
003535	150	PB	
003536	200	PB	
003553	100	PC	
003554	150	PC	

NECKED DOOR BOLT

	Product code:	Size (mm)	Finish:
	003543	75	PB
003544	100	PB	
003545	150	PB	
003552	75	PC	
003562	75	SAA	
003563	100	SAA	

ARCHITECTURAL STRAIGHT BARREL BOLT

	Product code:	Size (mm)	Finish:
	540007	152 x 32	SC
540008	152 x 38	SC	
540011	200 x 32	SC	
540012	200 x 38	SC	
540005	152 x 25	PB	
540006	152 x 32	PB	
540032	152 x 38	PB	

ARCHITECTURAL NECKED BOLT

	Product code:	Size (mm)	Finish:
	540009	152 x 32	SCP
540010	152 x 38	SCP	
540031	152 x 32	PB	
540026	152 x 38	PB	

ARCHITECTURAL SLIDE BOLT

	Product code:	Size (mm)	Finish:
	540003	152 x 35	SC
540004	152 x 35	PB	

BRASS FLUSH BOLT

Sizes in stock:	
Product code: 100mm: 003686 150mm: 003687	

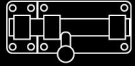

ARCHITECTURAL IRONMONGERY

IRONMONGERY ACCESSORIES



IRONMONGERY
ACCESSORIES

BEST SELLER 	FLUSH BOLT	Grade 304 SSS Bolt diameter: 11mm Bolt throw: 15mm Supplied with screws & flat receiver plate - Easyclean socket available separately	Product Code:	Size (mm)	Finish
			540000	150 x 20	SSS
			540001	200 x 20	SSS
			540002	13 (Easyclean Socket)	SC

SECURITY BOLT					WHITE SECURITY BOLT
	Product Code:	Length (mm)	Backset (mm)	Finish	 Size: 55mm Product code: 003475
	540013	37	17	EB	
	540014	37	17	PC	
	540015	37	17	SC	
	540016	61	32	EB	
	540017	61	32	PC	
	540018	61	32	SC	

OVAL THUMBTURN FOR SECURITY BOLT		
 Suitable for 61mm security bolt	Product Code:	Finish:
	540019	PB
	540020	PC
	540021	SC

SECURITY BOLT KEY
 Product code: 540022

SECURITY BOLT KEY
 Product code: 003478

INDICATOR BOLT			
	Product Code:	Size(mm)	Finish:
	540023	65 x 40mm	PB
	540024	65 x 40mm	PC
	540025	65 x 40mm	SC

ANTIQUE DOOR BOLT
 Sizes in stock: Product code: 150mm: 003825 200mm: 003826

ANTIQUE DOOR BOLT - CURLY TAILED
 Size: 100mm Product code: 009624

ARCHITECTURAL IRONMONGERY

IRONMONGERY ACCESSORIES

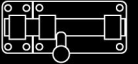

IRONMONGERY
ACCESSORIES

LOCKING DOOR CHAIN
 <p>Size: 110mm Finishes in stock:</p>
<p>Product code: Brass: 003566 PC: 003567</p>

NARROW DOOR CHAIN
 <p>Size: 44mm Finishes in stock:</p>
<p>Product code: Brass: 003568 PC: 003569</p>

LION HEAD KNOCKER
 <p>Sizes in stock:</p>
<p>Product code: 100mm: 003456 150mm: 003639</p>

	<p>STANDARD DOOR CHAIN</p>	<p>Plate size: 84 x 35mm Chain retainer size: 52 x 20mm Chain length: 200mm</p>	<p>Product Code:</p>	<p>Finish</p>
			570021	PB
			570022	PC
			570023	SC

VICTORIAN URN DOOR KNOCKER	Product Code:	Finish:	Size (mm)
	003637	Brass	125
	003638	Brass	150
	003735	PC	150

DOOR VIEWER - 160 DEGREES
 <p>Viewing angle: 160 degrees Finishes in stock:</p>
<p>Product code: Brass: 003570 PC: 003571</p>

VICTORIAN SLIM KNOCKER
 <p>Size in stock: 200mm</p>
<p>Product code: 003649</p>

DOOR VIEWER - 180 DEGREES	Product Code:	Finish:
 <p>Diameter: 14mm Suitable for door thickness 35 - 55mm</p>	570024	PB
	570025	PC
	570026	SC

FOX HEAD KNOCKER
 <p>Size in stock: 150mm</p>
<p>Product code: 003646</p>

ARCHITECTURAL IRONMONGERY

IRONMONGERY ACCESSORIES

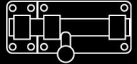

IRONMONGERY
ACCESSORIES

**We Cut
Keys!**

GEORGIAN URN KNOCKER



Sizes in stock:

Product code:
165mm: 003607 200mm: 003608

ANTIQUE LION DOOR KNOCKER



Size: 150mm

Product code: 003819

ANTIQUE RING HANDLE KNOCKER



Size: 125mm

Product code: 003820

VICTORIAN CYLINDER PULL



Size: 75mm
Finishes in stock:

Product code:
Brass: 003641 PC: 003736

ANTIQUE CYLINDER PULL



Size: 125mm

Product code: 003821

ALUMINIUM ESCUTCHEON



Size: 30mm

**Product code: Open: 008574
Covered: 008575**

COMMERCIAL CYLINDER PULL



Product Code:	Type:
550046	Standard keyway
550047	Euro profile
550048	Round rim cylinder
550049	Blank pull

VICTORIAN ESCUTCHEON



Product code:	Type:	Finish:
003644	Open	Brass
003643	Covered	Brass
003739	Open	PC
003738	Covered	PC

ARCHITECTURAL IRONMONGERY

IRONMONGERY ACCESSORIES

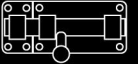

IRONMONGERY
ACCESSORIES

VICTORIAN BELL PUSH



Size: 75mm
Finishes in stock:

Product code:
PB: 003642 PC: 003737

ANTIQUE ESCUTCHEON



Sold as a pair
Size: 75mm

Product code: 003823

ANTIQUE BELL PUSH



Size: 120mm

Product code: 003820

GEORGIAN BELL PUSH



Size: 75mm

Product code: 003611

INTERNAL LETTER FLAP



Size: 280 x 75mm
Finishes in stock:

Product code:
Brass: 003634 PC: 003734

GEORGIAN LETTER PLATE



Sizes in stock:

Product code:
250mm: 003604 275mm: 003605

VICTORIAN GRAVITY LETTER PLATE



Size: 250 x 75mm

Product code: 003633

VICTORIAN LETTER PLATE WITH KNOCKER



Size: 250 x 75mm
Finishes in stock:

Product code:
Brass: 003632 PC: 003732

SHAPED LETTER PLATE



Size: 300mm
Finish: PC

Product code: 003733

ARCHITECTURAL IRONMONGERY

IRONMONGERY ACCESSORIES

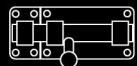

IRONMONGERY
ACCESSORIES

VICTORIAN LETTER PLATE

	Product code:	Size (mm)	Finish
	003629	250 x 76	Brass
	003731	250 x 76	PC
	003630	254 x 100	Brass
	003631	355 x 115	Brass

BRUSH LETTER BOX COVER



Size: 300mm
Colours in stock:

Product code:
White: 003444 Brown: 003445

ANTIQUE LETTER PLATE



Size: 250mm

Product code: 003814

ANTIQUE LETTER PLATE - PATTERNED



Size: 350mm

Product code: 003815

DOUBLE SIDED LETTER PLATE



Product code:	Door Thickness	Colour:
003773	20 - 40	Silver
003774	20 - 40	Gold
003775	20 - 40	White
003776	40 - 80	Silver
003777	40 - 80	Gold
003778	40 - 80	White



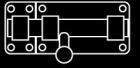

ARCHITECTURAL IRONMONGERY

IRONMONGERY ACCESSORIES





IRONMONGERY
ACCESSORIES

DOOR NUMBERS & LETTERS

	Product code:	Number/letter	Height (mm)	Finish:	
	003657	0	50	Brass	
	003658	1	50	Brass	
	003659	2	50	Brass	
	003660	3	50	Brass	
	003661	4	50	Brass	
	003662	5	50	Brass	
	003663	6	50	Brass	
	003664	7	50	Brass	
	003665	8	50	Brass	
	003666	9	50	Brass	
	003667	A	50	Brass	
	003668	B	50	Brass	
	003669	0	75	Brass	
	003670	1	75	Brass	
	003671	2	75	Brass	
	003672	3	75	Brass	
	003673	4	75	Brass	
	003674	5	75	Brass	
	003675	6	75	Brass	
	003676	7	75	Brass	
	003677	8	75	Brass	
	003678	9	75	Brass	
	003679	A	75	Brass	
	003680	B	75	Brass	
					

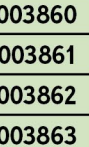
DOOR NUMBERS & LETTERS

	Product code:	Number/letter	Height (mm)	Finish:
	003855	0	50	PC
	003856	1	50	PC
	003857	2	50	PC
	003858	3	50	PC
	003859	4	50	PC
	003860	5	50	PC
	003861	6	50	PC
	003862	7	50	PC
	003863	8	50	PC
	003864	9	50	PC
	003865	A	50	PC
	003866	B	50	PC
	003749	0	75	PC
	003750	1	75	PC
	003751	2	75	PC
	003752	3	75	PC
	003753	4	75	PC
	003754	5	75	PC
	003755	6	75	PC
	003756	7	75	PC
	003757	8	75	PC
	003758	9	75	PC
	003747	A	75	PC
	003748	B	75	PC

ANTIQUÉ NUMERALS

	Product code:	Number/letter	Height (mm)
	003830	0	75
	003831	1	75
	003832	2	75
	003833	3	75
	003834	4	75
	003835	5	75
	003836	6	75
	003837	7	75
	003838	8	75
	003839	9	75

SILENT CABIN HOOK

	Product code:	Size (mm)	Finish:
	003688	75	Brass
	003689	100	Brass
	003690	150	Brass
	003691	200	Brass
	003692	250	Brass
	003759	100	PC
	003760	150	PC

ARCHITECTURAL IRONMONGERY

IRONMONGERY ACCESSORIES

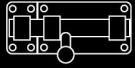

IRONMONGERY
ACCESSORIES

BRASS SUFFOLK LATCH SET



Size: 200mm

Product code: 003684

ANTIQUE SUFFOLK LATCH



Size: 200mm

Product code: 006478

BRASS CABIN HOOK



Sizes in stock:

Product code:
75mm: 003693
100mm: 003694

PROJECTION DOOR STOP



Product code:	Size (mm)	Finish:
003702	63	Brass
003703	75	Brass
003767	63	PC

CONCEALED PROJECTION DOOR STOP



Size: 63mm

Product code: 003704

OVAL DOOR STOP



Size: 50mm
Finishes in stock:

Product code:
Brass: 003700 PC: 003766

BRASS SHIELDED DOOR STOP



Size: 38mm

Product code: 003699

SPRING DOOR STOP



Size: 75mm

Product code:
Brass: 003701 Chrome: 003768

COMMERCIAL OVAL DOOR STOP

BEST
SELLER



Finish: SSS
Diameter: 40mm
Height: 24mm

Product code: 570011

BLACK RUBBER DOOR STOP



Diameter: 32mm
Height: 27mm

Product code: 570014

ARCHITECTURAL IRONMONGERY

IRONMONGERY ACCESSORIES

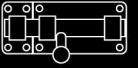

IRONMONGERY
ACCESSORIES

COMMERCIAL PROJECTION DOOR STOP

**BEST
SELLER**



Finish: SSS
Length: 75mm
Rose diameter: 37mm

Product code: 570012

COMMERCIAL SHIELDED DOOR STOP



Finish: SAA
Diameter: 35mm
Height: 30mm

Product code: 570013

ANTIQUE COAT HOOK



Sold as a pair
Size: 50mm

Product code: 003827

HAT AND TWIN ROBE HOOK



Size: 125mm
Finishes in stock:

Product code:
Brass: 003695 PC: 003762

HANDRAIL BRACKETS

Product code:	Size (mm)	Finish
003886	63	BZP
003779	63	Aluminium
003705	63	Brass
003761	63	PC
570019	63	White
570020	75	White
570017	63	SC
570018	75	SC

CHROME HOOKS ON PINE PLAQUE



Size: 220mm

Product code: 003923

COMMERCIAL HAT & COAT HOOK



Finish: SSS
Dimensions: 177 x 20mm
Projection: 42mm

Product code: 570000

COMMERCIAL ROBE HOOK



Finish: SSS
Dimensions: 70 x 20mm
Projection: 42mm

Product code: 570001

ARCHITECTURAL IRONMONGERY

IRONMONGERY ACCESSORIES

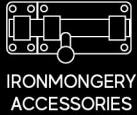

We Cut Keys!

BUFFERED HAT & COAT HOOK



Finish: SSS
Dimensions: 110 x 20mm
Projection: 44mm

Product code: 570002

CONTRACT HAT & COAT HOOK



Finish: SAA
Dimensions: 125 x 20mm

Product code: 570003

CONTRACT ROBE HOOK



Finish: SAA
Dimensions: 50 x 20mm

Product code: 570004

DOMESTIC ROBE HOOK



Product Code:	Size (mm)	Finish:
570005	44mm	PB
570008	44mm	PC

FANLIGHT CATCH



Size: 65mm
Finishes in stock:

Product Code:
Brass: 003709
PC: 003772

DOMESTIC HAT & COAT HOOK



Product Code:	Size (mm)	Finish:
570007	142mm	PB
570010	142mm	PC

CUPBOARD TURN



Size: 50mm
Finish: Brass plated

Product code:
003903

DOMESTIC DOUBLE ROBE HOOK



Product Code:	Size (mm)	Finish
570006	53mm	PB
570009	53mm	PC

CABINET BOLT



Size: 63mm
Finishes in stock:

Product Code:
PC : 003454
Brass: 003555

FLUSH RING HANDLE



Finish: Brass
Sizes in stock:

Product Code:
50mm: 003715
63mm: 003716

ARCHITECTURAL IRONMONGERY

IRONMONGERY ACCESSORIES

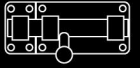



IRONMONGERY
ACCESSORIES

CLEAT HOOK			
	Product code:	Size (mm)	Finish:
	003769	75	Chrome
	003885	90	ZP
	003448	90	Black
	003884	110	Black

Sold individually

COUNTERFLAP CATCH		
	Product Code:	Finish:
	570033	PB
	570034	PC
	570035	SC

CHROME TUBE			
	Product Code:	Diameter (mm)	Length (mm)
	003915	19	600
	003916	19	900
	003917	19	1200
	003918	19	1500
	003919	19	1800
	003920	25	1200
	003921	25	1500
	003922	25	1800

RAIL BRACKETS - END SOCKET		
	Sold as pair Finish: Chrome Sizes in stock:	Product Code: 19mm: 003911 25mm: 003914

RAIL BRACKETS - END		
	Sold as a pair Finish: Chrome Sizes in stock:	Product Code: 19mm: 003910 25mm: 003913

RAIL BRACKETS - CENTRE		
	Finish: Chrome Sizes in stock	Product Code: 19mm: 003909 (sold as a pair) 25mm: 003912 (sold individually)

GEORGIAN BOW HANDLE		
	Sold individually Sizes in stock:	Product Code: 125mm: 003601 180mm: 003600

GEORGIAN PULL HANDLE		
	Sold individually Sizes in stock	Product Code: 125mm: 003602 165mm: 003603

VICTORIAN BOW HANDLE		
	Sold individually Sizes in stock:	Product Code: 150mm: 003623 175mm: 003624

ARCHITECTURAL IRONMONGERY

IRONMONGERY ACCESSORIES

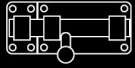



IRONMONGERY
ACCESSORIES

VICTORIAN PULL HANDLE		
	Sold individually Sizes in stock:	Product Code: 125mm: 003627 165mm: 003628

SHAKER HANDLE		
	Surface fixed Size: 96mm Sold as pair Finish: SC	Product Code: 003854

DRAWER PULL		
	Sold individually Size: 90mm Finish: Brass	Product Code: 003719

CUPBOARD D HANDLES		
	Sold as a pair Size: 95mm Surface fixed Finishes in stock:	Product Code: Brass: 003945 Chrome: 003946

ROUND CUPBOARD KNOB		
	Size: 30mm Sold as pair Finishes in stock:	Product Code: PC: 003848 SN: 003849

TOUCH LATCH		
	BZP	Product Code: 003902

VICTORIAN CUPBOARD KNOB			
	Product code:	Finish:	Size (mm)
	003710	Brass	20
	003711	Brass	25
	003712	Brass	30
	003713	Brass	35
Sold as pairs (003714 sold individually)			
003714	Brass	45	

OVAL CUPBOARD KNOB		
	Product Code:	Finish:
	003845	Polished chrome
	003846	Polished brass
Size: 35 mm Sold as pair		
003847	Brushed nickel	

BALL CUPBOARD KNOB		
	Product Code:	Finish:
	003842	PC
	003843	PB
Size: 25mm Sold as pair		
003844	SN	

PINE CUPBOARD KNOB		
	Product Code:	Size (mm)
	003850	30
	003851	35
	003852	40
Size: 35 mm Sold as pair		
003853	48	

ARCHITECTURAL IRONMONGERY

IRONMONGERY ACCESSORIES

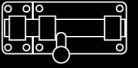



IRONMONGERY
ACCESSORIES



BALL BEARING DRAWER SLIDES		
	Sold as pair Size: 350mm BZP	Product Code: 003907

ROSE PACK FOR PULL HANDLES		
	Adapts commercial bolt-through pull handles to face-fixing Finishes in stock:	Product Code: SAA: 550293 SSS: 550050

ALUMINIUM PULL HANDLE		
	Sold individually Bolt through Sizes in stock:	Product Code: 100mm: 003782 150mm: 003783

BACK TO BACK FIXING KIT		
	Suitable for commercial pull handles Finish: SSS	Product Code: 550051

ALUMINIUM FLUSH PULL		
	Size: 90mm	Product Code: 003784

COMMERCIAL PULL HANDLE			
	Product code:	Size (mm)	Finish:
	550026	225 x 19	SSS
	550027	300 x 19	SSS
	550028	425 x 19	SSS
	550030	225 x 19	SAA
	550031	300 x 19	SAA
	550032	425 x 19	SAA
Sold individually Bolt through fixing BS EN1634-1 Grade 201 stainless steel			

COMMERCIAL FLUSH PULL		
	Finish: SSS Dimensions: 100 x 50mm Depth: 14mm	Product Code: 550041

BRASS FLUSH PULL		
	Size: 90mm	Product Code: 003718

ARCHITECTURAL IRONMONGERY

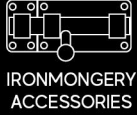



FRELAN
HARDWARE

The name of quality
architectural hardware

IRONMONGERY ACCESSORIES

OVAL GRIP PULL HANDLE			
	Product code:	Size (mm)	Finish:
	550035	225	SAA
	550036	300	SAA
	003682	225	PB

BOW HANDLE		
	Finish: SAA Size: 150mm	Product Code: 550296

COMMERCIAL PULL HANDLE ON BACKPLATE			
	Product code:	Back plate dimensions (mm)	Finish:
	550038	305 x 75	SAA
	550037	375 x 75	SAA
	550040	305 x 75	SSS
	550039	375 x 75	SSS

COMMERCIAL TOILET ROLL HOLDER		
	Finish: SSS Frame Size: 128 x 20mm Projection: 81.5mm	Product Code: 570036

CONTRACT TOILET ROLL HOLDER		
	Size: 135mm Colours in stock:	Product Code: Aluminium: 003780 White: 003781

GRAB RAIL			
	Product code:	Size (mm)	Finish:
	550300	305 x 35	Powder coated white
	550301	450 x 35	Powder coated white
	550302	600 x 35	Powder coated white

LOUVRED VENTS			
	Product Code:	Dimensions (inches)	Finish:
	003789	9 x 3	AL
	003790	9 x 6	AL
	003791	9 x 9	AL
	003792	24 x 3	AL
	003793	9 x 6	Gold
	003801	9 x 3	White plastic
	003802	9 x 6	White plastic
	003803	9 x 9	White plastic

COMMERCIAL FACE-FIXED PULL HANDLE			
	Product code:	Size (mm)	Finish:
	550033	225 x 19	SAA
	550034	305 x 19	SAA

ARCHITECTURAL IRONMONGERY

IRONMONGERY ACCESSORIES

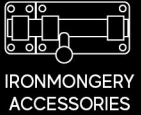

TWIN SLOT ROD BOOKEND



Supplied in pairs
Height: 120mm
Projection: 150mm

Product code: 570052

FINGER KEEPER



Length: 1960mm
Prevents finger trapping accidents in doors
Full fitting kit included
Easily removed and re-fitted to allow door maintenance
Colours in stock:

Product code: White: 570028 Brown: 570027

TWIN SLOT SHELVING

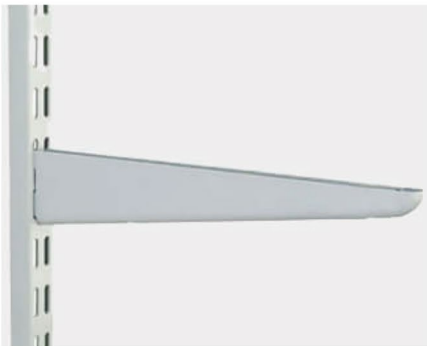

Strong and sturdy twin slot shelving system
Bacteria, fungus & mould resistant coating
Twinslot pitch: 32mm
Sold individually
Finish: White

UPRIGHTS

Product Code:	Height (mm)
570037	430
570038	710
570039	1000
570040	1220
570041	1600
570042	1980

SHELVING BRACKETS

Product Code:	Projection (mm)
570044	120
570045	170
570046	220
570047	270
570048	320
570049	370
570050	470

HIT AND MISS VENTS



Product Code:	Dimensions (inches)	Finish:
003794	9 x 3	AL
003795	9 x 6	AL
003796	9 x 9	AL
003797	9 x 3	Gold
003798	9 x 6	Gold
003801	9 x 3	White plastic
003802	9 x 6	White plastic
003803	9 x 9	White plastic

ARCHITECTURAL IRONMONGERY

SIGNAGE



SIGNAGE

**We Cut
Keys!**

STAINLESS STEEL SIGNAGE

Diameter: 76mm BS EN 1634-1 Screw fixing Finish: Satin stainless steel						
	Product Code: 580006	Product Code: 580004	Product Code: 580003	Product Code: 580005	Product Code: 580008	Product Code: 580007

STAINLESS STEEL SIGNAGE

Diameter: 76mm BS EN 1634-1 Screw fixing Finish: Satin stainless steel					
	Product Code: 580002	Product Code: 580001	Product Code: 580000	Product Code: 008885	Product Code: 008881

SELF-ADHESIVE PVC SIGNAGE

Size: 300 x 200mm					
	Product Code: 580010	Product Code: 580012	Product Code: 580009	Product Code: 580011	Product Code: 580013

RIGID PVC SIGNAGE

Non-adhesive			
	Product code: 580016 Size: 800 x 600mm	Product code: 006784 Size: 600 x 400mm	Product code: 006289 Size: 600 x 400mm

ARCHITECTURAL IRONMONGERY

SIGNAGE



SIGNAGE

RIGID PVC SIGNAGE					
Non-adhesive					
	Product code: 006279 Size: 200 x 300mm	Product code: 006198 Size: 200 x 300mm	Product code: 006315 Size: 200 x 300mm	Product code: 006312 Size: 200 x 300mm	

RIGID PVC SIGNAGE			
Non-adhesive			
	Product code: 006734 Size: 200 x 300mm	Product code: 580014 Size: 600 x 100mm	Product code: 006512 Size: 300 x 100mm

RIGID PVC SIGNAGE			
Non-adhesive			
	Product code: 009949 Size: 200 x 300mm	Product code: 009950 Size: 200 x 300mm	Product code: 009951 Size: 200 x 300mm

ARCHITECTURAL IRONMONGERY

SLIDING DOOR HARDWARE



SLIDING DOOR
HARDWARE

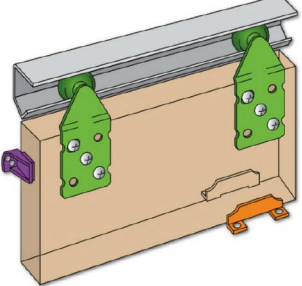
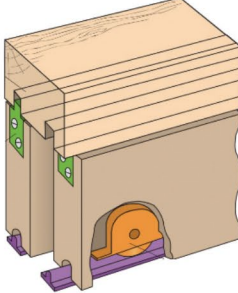
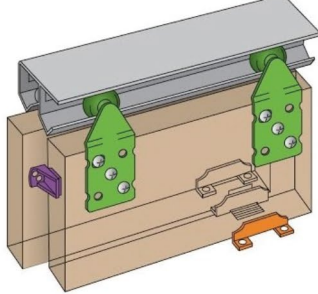
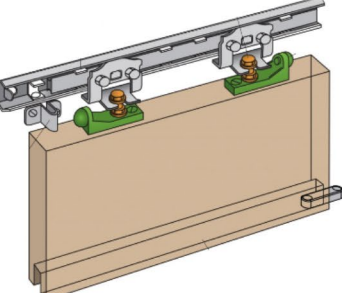

	<p>MORTICE HOOK LOCK</p>	<p>Suitable for 35-45mm thick doors Rose diameter: 60mm Edge pull diameter: 29mm Lock case width: 70mm Lock case backset: 50mm Hook bolt throw: 17mm</p>	<p>Product code:</p> <p>610000 610001 610002</p>	<p>Finish:</p> <p>PB PC SC</p>
	<p>SLIDING DOOR GEAR - SINGLE TRACK TOP HUNG</p>	<p>Single track for doors up to 45kg Max leaf width: 900mm Door thickness: 16-40mm Ideal for wardrobe doors</p>	<p>Product code: 610003</p>	
	<p>SLIDING DOOR GEAR - DOUBLE TRACK BOTTOM ROLLER</p>	<p>Double track for doors up to 23kg Max leaf width 900mm Door thickness 20-45mm Ideal for cupboards, bookcases and wardrobe doors</p>	<p>Product code: 1200mm track length: 610004 1800mm track length: 610005</p>	
	<p>SLIDING DOOR GEAR - DOUBLE TRACK TOP HUNG</p>	<p>Double track for doors up to 45kg Max leaf width 900mm Door thickness 16-40mm Ideal for bi-passing heavy duty cupboards, and wardrobe doors</p> <p>* Fittings kit available for additional door - Product Code: 610008</p>	<p>Product code: 1200mm track length: 610006 1800mm track length: 610007</p>	
	<p>TOP HUNG BALL BEARING GEAR</p>	<p>Single track for doors up to 55kg One-piece ball cage design Door thickness 16-40mm Smooth running and ideal for partitions</p> <p>Note: Unable to be cut down</p> <p>3 Sizes held in stock for various door widths</p>	<p>Product code: 750-900mm: 610009 900-1050mm: 610010 1050-1200mm: 610011</p>	

ARCHITECTURAL IRONMONGERY

UPVC DOOR HARDWARE

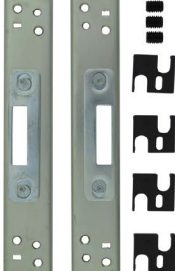

UPVC DOOR
HARDWARE

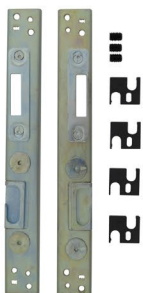
<p>BEST SELLER</p> 	<p>MULTIPOINT REPAIR LOCK - 2 HOOK & 2 ROLLER</p>	<p>This repair lock has the largest range of backsets on the market and has the greatest flexibility when replacing existing multipoint locks</p> <p>Supplied in 3 parts, this repair lock features 500mm of serrations to accept shoot bolts for added security</p> <p>Supplied with specific keeps designed to fit uPVC doors</p> <p>Features a non-handed gearbox with a latch that can be easily reversed</p> <p>Deadbolt throw: 20mm</p> <p>Adjustable roller cams optimise gasket compression for better heat and sound insulation</p> <p>Hooks with hardened steel inserts provide enhanced protection against attack</p>	<p>Product code:</p> <p>004395</p> <p>004396</p> <p>004393</p> <p>004394</p>	<p>Door material:</p> <p>Timber</p> <p>Timber</p> <p>uPVC</p> <p>uPVC</p>	<p>Lock backset (mm)</p> <p>35</p> <p>45</p> <p>35</p> <p>45</p>
	<p>UNIVERSAL HOOK KEEPS</p>	<p>An adjustable hookbolt keep set suitable for most types of multipoint locks</p> <p>Keeps are not profile specific as packers are supplied</p>	<p>Product code: 004390</p>		
	<p>UPVC LATCH & DEADBOLT KEEP</p>	<p>This adjustable latch/deadbolt centre keep is non-handed and is supplied with packers and grub screws to suit all profiles making it one of the most versatile keeps available</p> <p>A unique non-handed latch and deadbolt keep</p> <p>Supplied with packers and grub screws which allow the keep to suit any profile</p> <p>Also suitable for use with latch and hook gearboxes</p>	<p>Product code: 004388</p>		
	<p>HOOK AND ROLLER KEEP</p>	<p>A pair of hook and roller keeps suitable for a huge range of multipoint locks</p> <p>Supplied with packers and grub screws which allow the keep to suit any UPVC profile</p>	<p>Product code: 004389</p>		

ARCHITECTURAL IRONMONGERY

UPVC DOOR HARDWARE



UPVC DOOR
HARDWARE

SHOOT BOLT KIT

Contains reversible top or bottom shoot bolts with keeps suiting the Mitchells range of multipoint locks



Product code: 16mm faceplate: 004391
20mm faceplate: 004392

CONCEALED DOOR RESTRICTOR

A door restrictor, which features an adjustable stop position, creating an opening angle between 90 and 125 degrees

Prevents slamming or swinging of door

Designed to suit aluminium, UPVC and timber doors



Product code: 004397

SPLIT SPINDLE

These split spindles are split into two parts, with a central pin connecting them together, allowing each half to rotate independently



Product code: 004398

WINKHAUS OVERNIGHT LOCK GEARBOX

Lever operated latch and deadbolt

Centres: 92mm

Lock case height: 186mm

Euro profile

Single spindle

Faceplate: 16mm radiused



Product code:
Backset sizes in stock: 35mm: 008464 45mm: 008864

ERA MULTI-POINT GEARBOX

Lever operated latch and deadbolt

Split spindle

Centres: 92mm

Lock case height: 220mm

Universal handing



Product code:
Backset sizes in stock: 35mm: 008248 45mm: 008585

ADJUSTABLE UPVC LEVER HANDLES



Adjustable handle position to suit lock centres between 59 - 96mm
Adaptable backplate to accommodate a wide range of screw hole centres
Concealed external fixing head & outer plate for increased security
Double spring mechanism
Weather resistant finish
Sold as a pair
10 year mechanical guarantee

Product code:	Finish:	Size (mm):
550055	White	290 x 34
550056	Satin Silver	290 x 34
550057	Polished Silver	290 x 34
550058	Gold	290 x 34

ARCHITECTURAL IRONMONGERY

WINDOW HARDWARE



WINDOW HARDWARE

	WINDOW FRICTION HINGES	<p>A range of non-handed friction stays with metal ends Conveniently packaged in pairs with timber fixing screws 4mm packers provided so 13 and 17mm stack heights can be achieved</p> <p>Each stay can swing either way, so they are non-handed</p>	Product code:	Window material	Size (inches)
			004410	Timber	8
			004405	Timber	10
			004406	Timber	12
			004407	Timber	16
			004408	Timber	20
			004409	Timber	24
			004404	uPVC	8
			004399	uPVC	10
			004400	uPVC	12
			004401	uPVC	16
			004402	uPVC	20
			004403	uPVC	24

LOCKABLE CASEMENT FASTENER		
	Product Code:	Finish:
	600004	PB
	600005	PC
	600006	SC
	600007	White

INLINE LOCKING WINDOW HANDLE	
	<p>Handle spindle is turned in the espagnolette gearbox to throw locking points Locked and unlocked by key - push button to release</p> <p>Backplate: 62 x 17mm Screw centres: 43mm Supplied with 1 key Non-handed Suitable for UPVC windows Finishes in stock:</p>
	<p>Product code: White: 600012 PC: 600013</p>

	OFFSET LOCKING WINDOW HANDLE	<p>Handle spindle is turned in the espagnolette gearbox to throw locking points Locked and unlocked by key - push button to release</p> <p>Backplate: 67 x 17mm Screw centres: 43mm Spindle size: 40 x 7mm Supplied with 1 key, 2 bolts and 1 cover cap</p> <p>Handles are handed - (Right hand shown in picture) Suitable for UPVC windows</p>	Product Code:	Hand:	Finish:
			600014	L/H	White
			600015	R/H	White
			600016	L/H	PC
			600017	R/H	PC

ARCHITECTURAL IRONMONGERY

WINDOW HARDWARE



WINDOW HARDWARE

**We Cut
Keys!**

ALUMINIUM CASEMENT FASTENER



Size: 100mm

Product codes: 003788

ANTIQUE CASEMENT FASTENER



Size: 115mm

Product code: 003829

VICTORIAN CASEMENT FASTENER



Size: 105mm

Product code: 003654

VICTORIAN CASEMENT FASTENER



Size: 125mm

Product code: 003653

SASH FASTENER



Size: 65mm
Finish: Brass

Product code: 003708

QUADRANT ARM SASH WINDOW FASTENER



Architectural quality
Finish: SC

Product Code: 600010

VICTORIAN HOOK AND MORTICE FASTENER



Size: 100mm
Finishes in stock:

Product codes:
Brass: 003655 PC: 003741

FITCH SASH WINDOW FASTENER



Basic quality
Finishes in stock:

Product codes:
Zinc plated: 003469 Brass: 003470

FITCH SASH WINDOW FASTENER



Architectural quality
Finish: SC

Product Code: 600009

ARCHITECTURAL IRONMONGERY

WINDOW HARDWARE



WINDOW HARDWARE

SASH LIFT



Architectural quality
Finish: SC

Product Code: 600011

SASH LIFT



Basic quality
Size: 50mm
Finishes in stock:

Product codes:
Brass: 003706 PC: 003770

WINDOW/PATIO DOOR LOCK



Colours in stock:

Product Code: Silver: 003453
Brassed: 003455 White: 003471

SASH EYE



Size: 45mm
Finishes in stock:

Product code:
Brass: 003707 PC: 003771

BRIGHTON SASH WINDOW FASTENER



Basic quality
Finishes in stock:

Product Code:
Zinc plated: 003467 Brass: 003468

BRIGHTON SASH WINDOW FASTENER



Architectural quality
Finish: SC

Product Code: 600008

WINDOW STAY LOCK



Finish: Zinc plated

Product code: 003462

LOCKABLE CASEMENT STAY



Product Code:	Size (mm)	Finish:
600000	250	PB
600001	250	PC
600002	250	SC
600003	250	White

ARCHITECTURAL IRONMONGERY

WINDOW HARDWARE



WINDOW HARDWARE

ALUMINIUM CASEMENT STAY

	Product Code:	Size (mm)
	003785	200
	003786	250
	003787	300

WINDOW RESTRICTOR



Size: 90mm

Product code: 003465

VICTORIAN CASEMENT STAY - SPOON STYLE

	Product Code:	Size (mm)	Finish:
	003650	200	Brass
	003651	250	Brass
	003740	250	PC
	003652	300	Brass

BASIC CABLE WINDOW RESTRICTOR



Product code: 003466

ANTIQUE CASEMENT STAY



Size: 250mm

Product Code: 003828

BRASS SLIDING STAY



Size: 250mm

Product code: 003656

LOCKING CABLE WINDOW RESTRICTOR



Suitable for all window types
Limits the distance a window can open
Key holder can unlock the device to remove the cable which will then allow the window to fully open
Perfect for home, public and commercial applications
Cable length: 150mm Easy to install

Product Code: 600008

ARCHITECTURAL IRONMONGERY

KICK PLATES & FINGER PLATES



KICK & FINGER PLATES

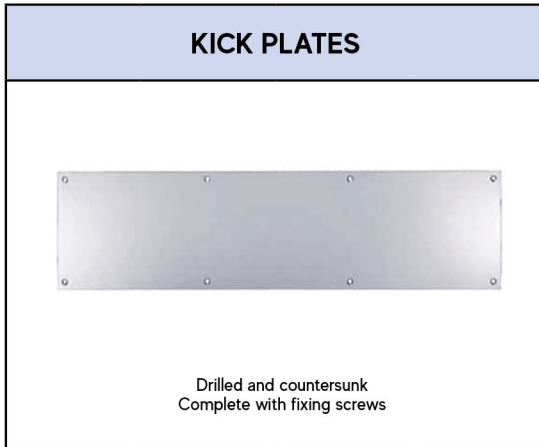

Product Code:	Length (mm)	Height (mm)	Finish:
550261	686	150	SAA
550262	700	150	SAA
550263	762	150	SAA
550071	800	150	SAA
550264	838	150	SAA
550265	864	150	SAA
550266	900	150	SAA
550267	686	200	SAA
550268	700	200	SAA
550269	762	200	SAA
550072	800	200	SAA
550270	838	200	SAA
550271	864	200	SAA
550272	900	200	SAA
550273	686	150	SSS
550274	700	150	SSS
550275	762	150	SSS
550073	800	150	SSS
550276	838	150	SSS
550277	864	150	SSS
550278	900	150	SSS
550279	686	200	SSS
550280	700	200	SSS
550281	762	200	SSS
550074	800	200	SSS
550282	838	200	SSS
550283	864	200	SSS
550284	900	200	SSS

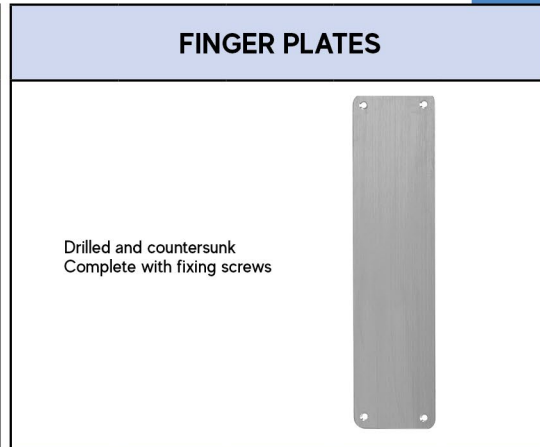

Product Code:	Height (mm)	Width (mm)	Finish:	Corners
550285	200	76	SAA	S
550286	250	76	SAA	S
550059	300	76	SAA	S
550061	350	76	SAA	S
550063	450	76	SAA	S
550287	200	76	SAA	R
550288	250	76	SAA	R
550060	300	76	SAA	R
550062	350	76	SAA	R
550064	450	76	SAA	R
550289	200	76	SSS	S
550290	250	76	SSS	S
550065	300	76	SSS	S
550067	350	76	SSS	S
550069	450	76	SSS	S
550291	200	76	SSS	R
550292	250	76	SSS	R
550066	300	76	SSS	R
550068	350	76	SSS	R
550070	450	76	SSS	R

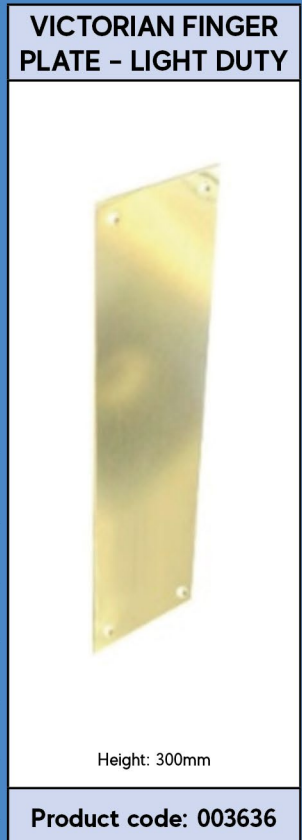

ARCHITECTURAL IRONMONGERY

INTUMESCENT PRODUCTS



INTUMESCENT
PRODUCTS

INTUMESCENT FIRE STRIP

Graphite based fire seal housed within PVC carrier
 Tested for 30 minutes with 10 & 15mm to BS 476 part 22 & 311
 Tested for 60 minutes with 20mm to BS 476 part 22 & 311
 Smoke seals tested to EN1634-3
 Tested to 100,000 open/close cycles

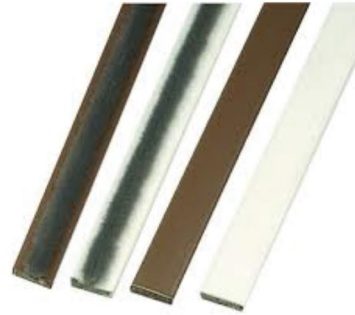

Product code:	Type:	Colour:	Profile Size: (mm)	Fire Rating:
590005	Fire only	White	10 x 4	30 mins
590000	Fire only	Brown	10 x 4	30 mins
590007	Fire only	White	15 x 4	30 mins
590002	Fire only	Brown	15 x 4	30 mins
590006	Fire & smoke	White	10 x 4	30 mins
590001	Fire & smoke	Brown	10 x 4	30 mins
590008	Fire & smoke	White	15 x 4	30 mins
590003	Fire & smoke	Brown	15 x 4	30 mins
590009	Fire & smoke	White	20 x 4	60 mins
590004	Fire & smoke	Brown	20 x 4	60 mins

INTUMESCENT PROTECTION FOR HARDWARE

Suitable for FD30 and FD60 applications
 Flexible 0.8mm thickness
 Self adhesive backed to assist fitting
 Will bend without cracking
 Unaffected by moisture, humidity & atmospheric pollution
 BS 476 part 22 : 1987 - 30 and 60 minute rating
 BS EN 1634-1 : 2008 - 30 and 60 minute rating

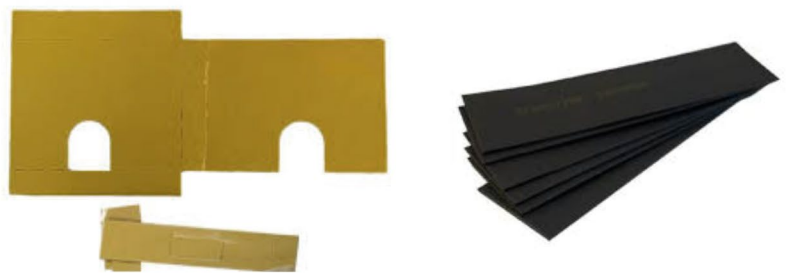

Product code	Application
590010	Hinge pads: 102 x 31mm - pack of 6
590011	Kit for flush bolt - max length 200mm
590012	Jacket & plate kit for DIN sized lock
590013	Jacket & plate kit for UK sized deadlock
590014	Jacket & plate kit for UK sized sashlock
590020	Jacket & plate kit for tubular latch
590015	Sheeting 500 x 500mm for general applications

ARCHITECTURAL IRONMONGERY

INTUMESCENT PRODUCTS



INTUMESCENT
PRODUCTS

	<p>INTUMESCENT LETTERBOX</p>	<p>Rated to FD30/FD30s Finish: SAA Tested to BS 476 part 22 & 311 Tested to EN 1634-3 30mins & BS EN13724 clause 665 Acoustic rating 32dB Adjustable to suit door thicknesses of 40mm to 80mm</p>	<p>Product code:</p>	<p>Aperture (mm)</p>	<p>Overall size (mm)</p>
			<p>590017</p>	<p>221 x 37.5</p>	<p>272 x 70</p>
			<p>590021</p>	<p>254.5 x 37.5</p>	<p>306 x 70</p>



INTUMESCENT THRESHOLD

FD60 Fire & smoke threshold

Finish: SAA

Suitable for inward & outward opening doors

Easy access for light wheeled traffic

Fitted with 60 min fire/smoke seal
NHBC approved
Tested to BS476 part 22 & 311

Seal is replaceable if damaged

Seals gaps of 12 – 15mm

Length: 914mm

Product code: 590019

	<p>FIRE RATED DOOR VIEWER</p>	<p>FD60 rated 120 degree viewing angle Suitable door thickness: 35 – 55mm Tested to BS 476 part 22 60 mins and EN 1634-1 30 mins Conforms to DHF TS002 : 2009 Specification Finish: PC</p>	<p>Product code: 590016</p>
---	--------------------------------------	--	--