

Mitchells

Ironmongers

...We've got it all covered



IRONMONGERY SCHEDULING

SPECIFICATION SERVICE

- Using your client's functional and aesthetic requirements, we will produce an ironmongery specification for your building project.
- We ensure all of our products are fit for purpose and achieve the relevant standards, including fire resistance and accessibility.
- Our extremely competitive pricing is partnered with high quality customer service, from specification stage through to after-sales service.
- Contractors will also benefit from our UK wide delivery service and the packing of the products into labelled 'door packs', so they know exactly which items are being fitted to each door.
- If you are an architect or contractor who is tired of being let down by your current ironmongery supplier, please get in touch by emailing sales@mitchellsironmongers.co.uk or give us a call on **01623 650065** and ask for contract ironmongery.

RECENT PROJECTS



Rufford Pastures - Edwinstowe
Residential housing



Wera distribution centre
Large commercial unit



The Evolve Trust - Mansfield
Education



Knights Close- NCHA
Housing association



Bicester Village - Oxford
Heritage / Retail



The Yews - Derby
Residential care home

CONTENTS

05 Architectural Ironmongery

62 Padlocks and Security

70 Hardware

102 Fixings

125 Sealants and Adhesives

131 Hand Tools

175 Landscaping Tools

187 Power Tools

193 Power Tool Accessories

242 Janitorial

251 Access

255 Site Electrical

260 Workwear and PPE

281 Bagged Aggregates

283 Calor Gas

ADDITIONAL SERVICES

Key Cutting



Calor Gas Stockist



Blade Sharpening



UK Wide Delivery



Special Orders for Products we don't Stock



LIST OF ABBREVIATIONS

FULL DESCRIPTION	ABBREVIATION	FULL DESCRIPTION	ABBREVIATION
Satin chrome	SC	Radiused corner	R
Satin chrome plated	SCP	Satin stainless steel	SSS
Polished chrome	PC	Satin anodised aluminium	SAA
Electro-brassed	EB	Black aluminium	BA
Polished brass	PB	Nickel plated	NP
Bright zinc plated	BZP	Keyed to differ	KTD
Satin nickel plated	SNP	Keyed alike	KA
White	WH	Physical vapor deposition	PVD
Black	BK	Satin stainless with satin nickel arm	SSN
Self-colour	S/C	Satin nickel	SN
Galvanised	GLV	Zinc plated	ZP
Silver	SE	Stainless steel	SS
Right-handed	R/H	Satin zinc	SZ
Left-handed	L/H	Aluminium	AL
Straight corner	S	Fire door rating	FD30/60

DOOR CLOSER TERMINOLOGY

Latch/latching action – Acceleration of the door in the final stages of the closing cycle.

Backcheck – Prevents the slamming of the door against its surround when forcibly thrown open.

Delayed action – Prolongs the closing time of a door when in an area of high traffic.

Closer size	Door width	Door weight
1	750mm	20Kg
2	850mm	40Kg
3	950mm	60Kg
4	1100mm	80Kg
5	1250mm	100Kg
6	1400mm	120Kg

LOCK TERMINOLOGY

Forend – The front faceplate of the lock.

Backset – The distance between a lock's spindle mechanism and its forend.

Centres – The distance between a lock's spindle mechanism and its lock piercing.



ARCHITECTURAL IRONMONGERY

DOOR CONTROLS ■

DOOR HANDLES ■

HINGES ■

LOCKS ■

PANIC HARDWARE ■

ACCESSORIES ■

SIGNAGE ■

SLIDING DOOR HARDWARE ■

UPVC DOOR HARDWARE ■

WINDOW HARDWARE ■

KICK PLATES & FINGER PLATES ■

INTUMESCENT PRODUCTS ■

Mitchells

Ironmongers

ARCHITECTURAL IRONMONGERY





DOOR CONTROLS





DOOR CONTROLS

SURFACE MOUNTED DOOR CLOSER	
	<p>Suitable for doors up to 50kg</p> <p>Double spring closing</p> <p>For 30-minute fire resistant doors if used in conjunction with a lock or latch mechanism</p>
Product code: 510011	

CONCEALED DOOR CLOSER	
	<p>For doors up to 50kg (two can be fitted to doors over 50kg)</p> <p>Suitable for 30-minute fire resistant doors</p> <p>Tested to BS 476 PT22: 1987</p> <p>Finishes in stock:</p> <ul style="list-style-type: none"> Satin chrome Electro brass
Product code: SC: 510012 EB: 510013	

ZOO OVERHEAD DOOR CLOSER: LIGHT DUTY	
BEST SELLER 	<p>Fixed power size 3</p> <p>For inward and outward opening doors</p> <p>Suitable for doors up to 60kg and 950mm wide</p> <p>Adjustable closing speed and latch speed</p> <p>10-year manufacturer's warranty</p> <p>Certifire Rated</p> <p>Tested to BS EN 1154</p> <p>Finish: Silver</p>
Product code: 510009	

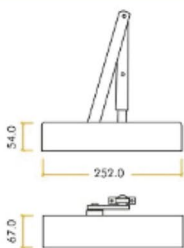
DORMA OVERHEAD DOOR CLOSER: LIGHT DUTY	
	<p>Power size 2 - 4</p> <p>For inward and outward opening doors</p> <p>Suitable for doors up to 1100mm width</p> <p>Adjustable closing speed and reliable latching action</p> <p>Certifire approved</p> <p>Tested to BS EN 1154</p> <p>Finish: Silver</p>
Product code: 510005	

ZOO OVERHEAD DOOR CLOSER: MEDIUM DUTY WITH OPTIONAL DELAYED ACTION FACILITY	
	<p>Power size 2-4 adjustable by spring</p> <p>For inward and outward opening doors</p> <p>Semi-radiused cover & adjustable flat arm</p> <p>Latching action and adjustable power by spring</p> <p>Adjustable Delayed Action facility</p> <p>Suitable for doors up to 80Kg in weight and 1100mm in width</p> <p>10-year manufacturer's warranty</p> <p>Tested to BS EN 1634-1</p> <p>Tested to BS EN 1154</p> <p>Certifire rated</p>
Product code:	Finish:
510017	Silver
510018	SSS
510019	PVD Gold
	

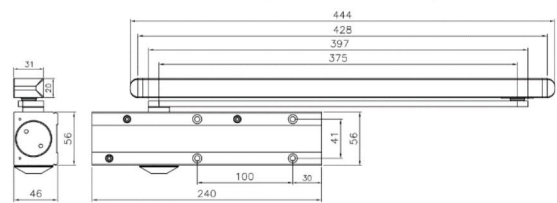
CAM ACTION DOOR CLOSER		
	<p>Power size 2-4 adjustable by valve</p> <p>Adjustable closing power, speed, latch action and backcheck</p> <p>Certifire rated</p> <p>Tested to BS EN 1634-1: 2-hour timber fire doors</p> <p>Tested to BS EN 1154</p> <p>Capable of meeting the opening force requirements of ADM and BS8300</p>	
Product code:	Finish:	Fitting side:
006584	SSN	Pull side
510004	Silver	Pull side
006561	SSN	Push side
510003	Silver	Push side
		

NHN OVERHEAD DOOR CLOSER: MEDIUM DUTY	
	<p>Power size 2-4 adjustable by spring</p> <p>For inward and outward opening doors</p> <p>Latching action and adjustable power</p> <p>Suitable for doors 40-80Kg in weight and 850-1100mm in width</p> <p>10-year manufacturers guarantee</p> <p>Tested to BS EN 1634-1: 2-hour timber fire doors</p> <p>Tested to BS EN 1154</p> <p>Finish: Silver</p>
Product code: 510010	

SYNERGY OVERHEAD DOOR CLOSER: MEDIUM DUTY	
	<p>Power size 2 - 4 adjustable by template</p> <p>For inward and outward opening doors</p> <p>Suitable for doors up to 80Kg and 1100mm width</p> <p>Adjustable closing speed and latch action</p> <p>Certifire rated</p> <p>Tested to BS EN 1634-1: 2-hour timber fire doors</p> <p>Tested to BS EN 1154</p> <p>Finish: Silver</p>
Product code: 510000	

ARCHITECTURAL IRONMONGERY

DOOR CONTROLS



DOOR CONTROLS

SYNERGY OVERHEAD DOOR CLOSER: MEDIUM DUTY



Power size 2 - 4 adjustable by spring
 Suitable for inward and outward opening doors
 Suitable for doors up to 80kg and 1100mm width
 Adjustable closing speed, latch action and backcheck
 Elegant radiused cover
 Certifire rated
 Capable of meeting the requirements of BS8300 and Approved Document M
 Tested to BS EN 1634-1: 2-hour timber fire doors
 Tested to BS EN 1154
 Finishes in stock: Silver, Satin nickel & Polished brass

Product code: S: 510001, SN: 510002, PB: 006981

DORMA OVERHEAD DOOR CLOSER: MEDIUM DUTY

BEST SELLER



Power size 2-4 adjustable by valve
 For inward and outward opening doors
 For doors up to 80KG and up to 1100mm in width
 Adjustable closing force, closing speed and latching action
 Certifire rated
 Tested to 1634-1: 2-hour timber doors and 4-hour steel fire doors
 Tested to BS EN 1154
 Finish: Silver

Product code: 510006

BRITON OVERHEAD DOOR CLOSER: HEAVY DUTY



Power size 1-4 adjustable by valve
 For inward and outward opening doors
 Suitable for doors up to 1100mm width and 80Kg in weight
 Adjustable latch action, closing action and backcheck
 Tested to BS EN 1634-1: 2-hour timber fire doors and 4-hour steel fire doors
 Certifire rated
 Tested to BS EN 1154
 Capable of meeting the low opening forces required to meet BS 8300:2001
 Finish: Silver

Product code: 510008

DORMA OVERHEAD DOOR CLOSER: HEAVY DUTY



Power size 2-5 adjustable by valve
 For inward and outward opening doors
 To suit doors up to 100kg and 1250mm in width
 Adjustable power, "thinking" backcheck and delayed action
 Tested to BS EN 1634-1: 2-hour timber fire doors and 4-hour steel fire doors
 Certifire rated
 Tested to BS EN 1154
 Finish: Silver

Product code: 510007

ELECTRO-MAGNETIC DOOR CLOSER



Power size 4
 For inward and outward opening doors
 Suitable for doors up to 80Kg and 1100mm in width
 Adjustable latching and sweep speed
 Hold open and swing free functions
 2-year guarantee
 Tested to BS EN 1634-1: 2-hour timber fire doors and 4-hour metal fire doors
 Certifire rated
 Tested to BS EN 1155
 Finish: Silver

Product code: 510015

DORMA FLOOR SPRING



Power size 1 - 4
 Universally handed
 Suitable for doors up to 120Kg and 1100mm in width
 Adjustable closing force, mechanical backcheck and hold open at 90 and 105 degrees
 Requires either a double action or single action accessory pack to operate
 Tested to BS EN 1634-1: 1-hour timber fire doors and 4-hour metal fire doors
 Tested to BS EN 1154

Product code: 006921

DORGARD

BEST SELLER



Holds open fire doors, allowing them to close automatically on the sound of a fire alarm
 Installed at the bottom of a door in under 5 minutes
 Listens for a continuous alarm for 14 seconds
 Adheres to
 BS EN 61000-6-3:2007
 BS EN 50130-4:2011
 BS EN 1155:1997
 BS EN 1634-1:2008

Product code: 510016

DOUBLE ACTION FLOOR SPRING KIT



Complete with arms and cover plate
 Allows door to swing in both directions
 Finish: SSS

Product code: 006397

SINGLE ACTION FLOOR SPRING KIT



Includes arms and cover plate
 Allows door to swing in one direction
 Finish: SSS

Product code: 006194

DOOR SELECTOR



Finish: SAA
 Ensures correct door closing sequence
 To suit rebated double doors
 Designed to be fitted to the first opening leaf
 Adheres to BS EN 1158
 Suits timber doors up to 1220mm width

Product code: 510014

SURFACE LIMITING STAY



Finish: Matt silver
 Limits opening angle of door/window to 90 degrees
 FD30/60 rated

Product code: 008822



DOOR CONTROLS

POWERMATIC CONCEALED DOOR CLOSER

Power size 3

Suitable for doors up to
80Kg and 950mm in width

Adjustable closing speed
and power latching action

Can be used with electronically
powered hold open devices

10-year guarantee

Certifire rated

Tested to BS EN 1634-1:
1-hour and 30-minute
timber fire doors

Tested to BS EN 1154

Contributes to achievement
of BS 8300: 2009

Finishes available:

SC: 006898

PB: 006879

SSS: 006898

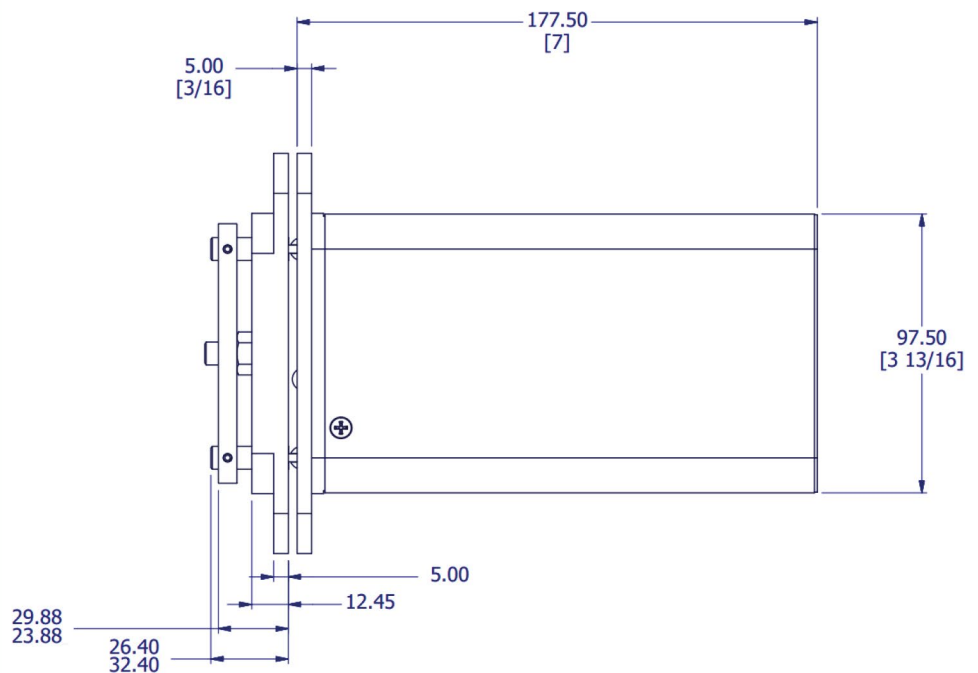
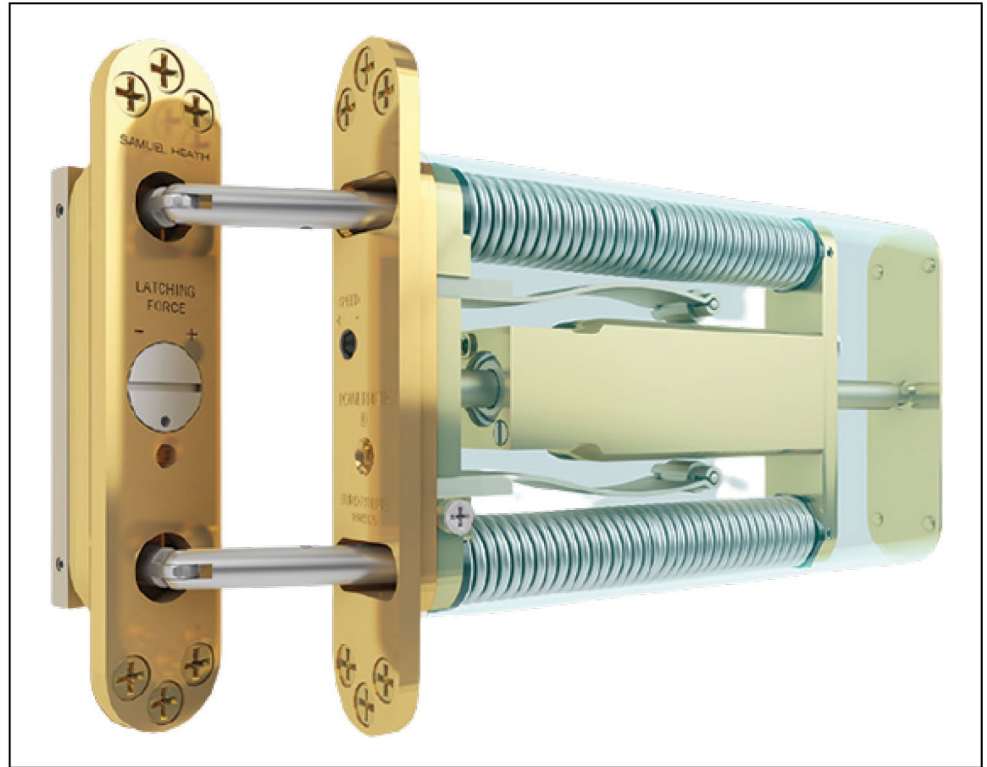

ARCHITECTURAL IRONMONGERY

DOOR HANDLES



DOOR HANDLES

ARCHITECTURAL LEVER ON ROSE - SSS

BEST SELLER

Finish: SSS
 Sold as a pair
 Rose diameter: 52mm
 Handle thickness: 19mm
 Sprung
 Grade 304 satin stainless
 Supplied with screws & back to back fixings
 Suitable for FD30 & FD60 doors
 Complies to the design requirements of BS8300
 Tested to BS EN 1906 Grade 3
 10 year mechanical guarantee



Product code: 550000

ARCHITECTURAL LEVER ON ROSE - SAA

Finish: SAA
 Sold as a pair
 Rose diameter: 52mm
 Handle thickness: 19mm
 Sprung rose
 Supplied with screws & back to back fixings
 Suitable for FD30 & FD60 doors
 Complies to the design requirements of BS8300
 Tested to BS EN 1906 Grade 3
 10 year mechanical guarantee



Product code: 550007

CONTRACT LEVER ON ROSE - SAA

Finish: SAA
 Sold as a pair
 Rose diameter: 52mm
 Handle thickness: 19mm
 Sprung rose with push on cover
 Supplied with screws & back to back fixings
 Complies to the design requirements of BS8300
 Tested to BS EN 1634-1
 10 year mechanical guarantee



Product code: 550053

FACILITY INDICATOR LOCK

Grade 304 satin stainless steel
 Reversible handing
 Supplied with keeps for both hinged & sliding door
 Suitable for FD30 & FD60 doors
 Complies to the design requirements of BS8300
 10 year mechanical guarantee



Product code: 520050

'RADAR' NATIONAL KEY SYSTEM LOCK

Lever operated
 Often used to access facilities reserved for less able customers
 Can be operated by all NKS (RADAR) Keys
 Set includes a mortice lock, key, strike plate & handle set
 Complete with fixing screws & bolts



Product code: 520061 * Extra Keys with large head - 001988

ARCHITECTURAL IRONMONGERY



DOOR HANDLES

We Cut Keys!

DOOR HANDLES

CONTRACT LEVER ON BACKPLATE - SAA



Finish: SAA
Sold as a pair
Supplied with screws
Tested to BS EN 1634-1

Product code:	Type:	Size (mm):
550042	Latch	102 x 40
550043	Euro Profile	154 x 40
550044	Bathroom Privacy	154 x 40
550045	Standard Keyway	154 x 40
550260	Oval Profile	154 x 40

COMMERCIAL ESCUTCHEONS & TURNS



Push on rose

Product code:	Type:	Size (mm)	Finish:
550004	Blank	52 x 8	SSS
550001	Euro profile	52 x 8	SSS
550002	Standard keyway	52 x 8	SSS
550003	Oval profile	52 x 8	SSS
550005	Turn & indicator release	52 x 8	SSS
550006	Large Turn & indicator release	52 x 8	SSS
550011	Blank	52 x 8	SAA
550008	Euro profile	52 x 8	SAA
550009	Standard keyway	52 x 8	SAA
550010	Oval profile	52 x 8	SAA
550054	Turn & indicator release	52 x 8	SAA
550013	Large turn & indicator release	52 x 8	SAA

ARCHITECTURAL LEVER ON BACKPLATE



Thickness of lever: 19mm
Sprung
Push on covers
Sold as a pair
Supplied with screws
Suitable for FD30 & FD60 doors
Complies to the design requirements of BS8300
Tested to BS EN 1906 Grade 3
10 Year mechanical guarantee
Grade 304 SSS

Product code:	Type:	Size (mm)	Finish:
550014	Latch	180 x 45	SSS
550015	Euro Profile	180 x 45	SSS
550017	Bathroom Turn & Release	180 x 45	SSS
550019	Standard Keyway	180 x 45	SSS
550020	Oval Profile	180 x 45	SSS
550016	Euro DIN lock	180 x 45	SSS
550018	Bathroom DIN lock	180 x 45	SSS
550021	Latch	178 x 44	SAA
550022	Euro Profile	178 x 44	SAA
550023	Bathroom Turn & Release	178 x 44	SAA
550024	Standard Keyway	178 x 44	SAA
550025	Oval Profile	178 x 44	SAA
550259	Euro DIN lock	178 x 44	SAA
550258	Bathroom DIN lock	178 x 44	SAA

ARCHITECTURAL IRONMONGERY

DOOR HANDLES



DOOR HANDLES

DOMESTIC BRASS LEVERS ON BACKPLATE

Finish: Dual finish

Sold as a pair

Backplate size: 180 x 48mm

Supplied with woodscrews

10- year mechanical guarantee

BS EN 1634-1



Product code:	Type:	Finish:
550106	Euro Profile	Satin Brass/Polished Brass
550107	Euro Profile	Satin Chrome/Polished Chrome
550108	Standard Keyway	Satin Brass/Polished Brass
550109	Standard Keyway	Satin Chrome/Polished Chrome
550110	Latch	Satin Brass/Polished Brass
550111	Latch	Satin Chrome/Polished Chrome
550112	Bathroom	Satin Brass/Polished Brass
550113	Bathroom	Satin Chrome/Polished Chrome

VICTORIAN LEVER HANDLES

Sold as a pair



Product code:	Type:	Finish:
003614	Lock	Brass
003615	Latch	Brass
003616	Bathroom	Brass
003617	Privacy	Brass
003724	Lock	Chrome
003725	Latch	Chrome
003726	Bathroom	Chrome
003727	Euro lock	Chrome

ARCHITECTURAL IRONMONGERY

DOOR HANDLES



DOOR HANDLES

VICTORIAN SCROLL LEVER HANDLES

VICTORIAN SCROLL LEVER HANDLES			
Sold as a pair	Product code:	Type:	Finish:
	003618	Lock	Brass
	003619	Latch	Brass
	003620	Bathroom	Brass
	003621	Privacy	Brass
	003720	Lock	Chrome
	003721	Latch	Chrome
	003722	Bathroom	Chrome
	003723	Privacy	Chrome

	VICTORIAN OVAL MORTICE KNOBSET	Size: 65mm Sold as a pair	Finish:	Product code:
			Brass	003625
			Polished chrome	003730

	VICTORIAN CENTRE DOOR KNOB	Size: 75mm Sold individually	Finish:	Product code:
			Brass	003640
			Polished chrome	003728

	VICTORIAN ROUND MORTICE KNOBSET	Size: 60mm Sold as a pair	Finish:	Product code:
			Brass	003622
			Polished chrome	003729





	PLASTIC MORTICE KNOBSET	Size: 60mm	Colour:	Product code:
			White	003799
			Brown	003800

ARCHITECTURAL IRONMONGERY

DOOR HANDLES



DOOR HANDLES

	GEORGIAN MORTICE KNOBSET	Size: 65mm Sold as a pair	Product code: 003599
	ANTIQUE SPRUNG MORTICE KNOBSET	Sold as a pair Size: 55mm	Product code: 003812
	ANTIQUE CENTRE DOOR KNOB	Sold individually Size: 63mm	Product code: 003813
	VICTORIAN RIM KNOBSET	Size: 50mm Finish: Brass	Product code: 003626

PASSAGE KNOBSETS

Product code:	Knobset type:	Backset (mm)	Finish:
009883	Entrance	60 / 70	Brass
003742	Privacy	60 / 70	Brass
003743	Passage	60 / 70	Brass
003744	Entrance	60 / 70	SSS
003745	Privacy	60 / 70	SSS
003746	Passage	60 / 70	SSS



	FLEUR DE LYS HANDLES	Sold as a pair Size: 190mm	Types in stock:	Products code:
			Lever latch	003808
			Lever lock	003807

ARCHITECTURAL IRONMONGERY



DOOR HANDLES

We Cut Keys!

ZOO
ARCHITECTURAL HARDWARE







DOOR HANDLES

	GEORGIAN LEVER HANDLES	Sold as a pair	Types in stock:	Product code:
			Lever lock	003595
			Lever latch	003596
			Bathroom	003597
Privacy	003598			
	ANTIQUE LEVER HANDLES	Sold as a pair Backplate height: 150mm	Types in stock:	Product code:
			Lever latch	003811
			Lever lock	003809
Bathroom	003810			
	TAYLOR SPINDLE	For face fixing lever or knob into position	Product code: 550295	

DOMESTIC LEVERS ON ROSE

Rose diameter: 50mm
Rose thickness: 8mm
Sold as a pair
Screw-on outer rose

Supplied with screws & back to back fixings
Suitable for use on FD30 & FD60 doors
Tested to BS EN 1634-1

		
Finish: Polished chrome	Finish: Satin chrome	Finish: Satin chrome
Product code: 550081	Product code: 550084	Product code: 550088
		
Finish: Satin chrome	Finish: Polished chrome/Black aluminium	Finish: Polished chrome
Product code: 550082	Product code: 550085	Product code: 550089

ARCHITECTURAL IRONMONGERY

DOOR HANDLES



DOOR HANDLES



Finish: Polished chrome

Product code: 550083



Finish: Polished chrome/SSS

Product code: 550086



Finish: Satin chrome

Product code: 550090



Finish: Polished chrome

Product code: 550087



Finish: Polished chrome

Product code: 550091



Finish: Polished chrome

Product code: 550105



Finish: Satin chrome

Product code: 550092



Finish: Polished chrome

Product code: 550097



Finish: Polished chrome/SSS

Product code: 550101



Finish: Satin chrome/Polished chrome

Product code: 550093

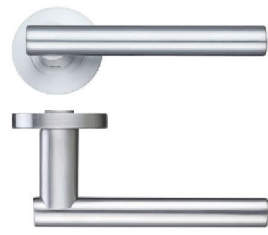

Finish: Satin chrome

Product code: 550098



Finish: Satin chrome/Polished chrome

Product code: 550102

ARCHITECTURAL IRONMONGERY

DOOR HANDLES



DOOR HANDLES



Finish: Satin chrome

Product code: 550095



Finish: Satin chrome/Polished chrome

Product code: 550099



Finish: Satin chrome/Polished chrome

Product code: 550103



Finish: Satin chrome/Polished chrome

Product code: 550096



Finish: Polished chrome/Satin nickel

Product code: 550100



Finish: Polished chrome/SSS

Product code: 550104

DOMESTIC ESCUTCHEONS & TURNS



Product code:	Type:	Finish:
550075	Euro profile escutcheon	PC
550076	Euro profile escutcheon	SC
550077	Standard keyway escutcheon	PC
550078	Standard keyway escutcheon	SC
550079	Turn & release	PC
550080	Turn & release	SC

ARCHITECTURAL IRONMONGERY

DOOR HANDLES



DOOR HANDLES

FIXING PACK

Back to back fixing pack



Product code: 550052

HALF SPINDLES

Allows each side to operate independently

For use with split spindle lock cases with an 8mm follower

Supplied as a pair

Shorter spindle to suit external side



Product code: 550297

SPLIT SPINDLE FOR DIN ESCAPE LOCKS

Size: 120 x 8mm

To suit split follower DIN escape cases with passthrough followers only

Crimped stop on inside/sprung pin on outside



Product code: 550298

SPINDLE - 8MM

Length: 140mm
Sold individually



Product code: 003626

SPINDLE - 5MM

Length: 120mm
Sold individually



Product code: 006395

SPINDLE ADAPTOR SLEEVE

Changes 5mm spindle to 8mm
30mm Long



Product code: 550299

ARCHITECTURAL IRONMONGERY

HINGES



HINGES

BALL BEARING BUTT HINGES

Tested to BS EN 1935

Grade 201 Stainless Steel

Sold in Pairs

500003 & 500006 available in pack of 3 hinges
Suitable for FD30/60 fire doors when fitted
with intumescent hinge pads (590010)

**BEST
SELLER**



Product code:	Leaf height (mm)	Total width (mm)	Knuckle width (mm)	Leaf thickness (mm)	Finish:	Corners:	Grade:
500003	102	76	14.5	3	SSS	S	13
500004	102	76	14.5	3	PSS	S	13
500005	102	76	14.5	3	PVD	S	13
500006	102	76	14.5	3	SSS	R	13
500000	76	50	11.5	2	SSS	S	7
500001	76	50	11.5	2	PSS	S	7
500002	76	50	11.5	2	PVD	S	7

STEEL BUTT HINGES

Zinc plated steel butt hinges

Unsuitable for fire doors

Sold in pairs



Product code:	Leaf height (mm)	Total width (mm)	Leaf thickness (mm)	Finish:	Corners:	Light duty/ Heavy duty:
500025	63	45	2	ZP	S	L
500009	75	50	2	ZP	S	L
500010	100	70	2	ZP	S	L
500011	75	64	3	ZP	S	H
500012	100	75	3	ZP	S	H

ARCHITECTURAL IRONMONGERY

HINGES

FRELAN
HARDWARE

The name of quality
architectural hardware



DOUBLE PRESSED STEEL BUTT HINGES

Sold in pairs
Leaf consists of a double steel layer
Often used in welding applications
Available with or without holes
Unsuitable for fire doors

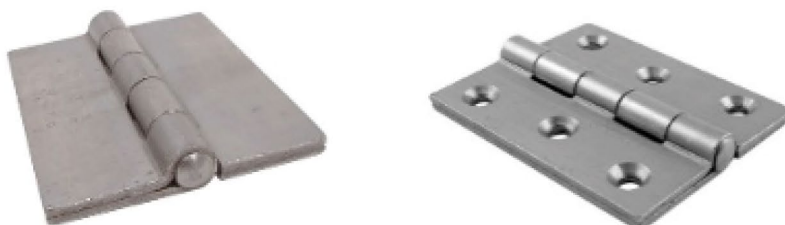

Product code:	Leaf height (mm)	Total width (mm)	Leaf thickness (mm)	Holes:	Finish:	Corners:
500013	100	75	4	Y	ZP	S
500014	100	75	4	N	S/C	S

BRASS BUTT HINGES

Sold in pairs



Product code:	Leaf height (mm)	Finish:	Corner:
003867	25	EB	S
003868	38	EB	S
003869	63	EB	S

RISING HINGES

Rising hinges are held together by a door's weight

They allow doors to self-close and to rise above any obstacles a door may face during its opening cycle

Finish: Zinc plated

Size: 75 x 72mm

Sold in pairs only – pair & half sets NOT to be fitted as it may affect closing cycle



Product code:

Right-handed: 500030

Left-handed: 500029

DOUBLE STAINLESS STEEL WASHERED HINGES

Sold in pairs



Product code:	Leaf height (mm)	Total width (mm)	Leaf thickness (mm)	Finish:	Corners:
500038	76	50	2.5	PB	S
500037	102	67	4	PB	S

SINGLE ACTION SPRING HINGE

Act as door closing devices in situations where an overhead door closer would be unsuitable

Sold in packs of 3

30-minute fire tested

Suitable for doors up to 60Kg

6 adjustable settings

Finish: SC

Dimensions: 102 x 75 x 3mm



Product code:

500032

ARCHITECTURAL IRONMONGERY



We Cut Keys!

HINGES

DOUBLE ACTION SPRING HINGES

Allow doors to swing in both directions
Ideal for commercial kitchens
Sold in pairs

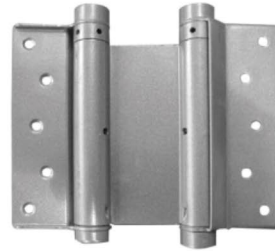

Product code:	Leaf height (mm)	Total hinge width (mm)	Mid-section height (mm)	Mid-section width (mm)	Knuckle thickness (mm)	Door thickness (mm)	Door weight (Kg)	Finish:
500008	150	176	136	48	26	35 - 40	40kg	Silver
500007	100	129	87	35	20	25 - 30	22kg	Silver

FLUSH HINGES

Sold in pairs



Product code:	Leaf height (mm)	Finish:	Corners:
003874	40	EB	S
003875	50	EB	S
006389	60	EB	S
003876	75	EB	S
003877	40	ZP	S
003878	50	ZP	S
003879	60	ZP	S
003880	75	ZP	S

STORM-PROOF HINGES

Sold in pairs
Leaf height: 63mm
Finish: Zinc plated



Product code:
500031

CRANKED FLUSH HINGE

Leaf height: 50mm
Finish: Electro Brass
Sold in pairs



Product code:
006159

ARCHITECTURAL IRONMONGERY

HINGES

FRELAN
HARDWARE

The name of quality
architectural hardware



PARLIAMENT HINGES

Utilised when a door needs to avoid any obstructive door facings

Sold in packs of 3



Product code:	Leaf height (mm)	Total width (mm)	Leaf thickness (mm)	Total central gap (mm)	Finish:
003870	100	130	4	80	PB
003872	100	130	4	80	SC
003871	100	130	4	80	PC

BACKFLAP HINGES

Finish: ZP

Sold in pairs

Total width: 60mm

Leaf height: 25mm



Product code:

003873

COUNTER FLAP HINGES

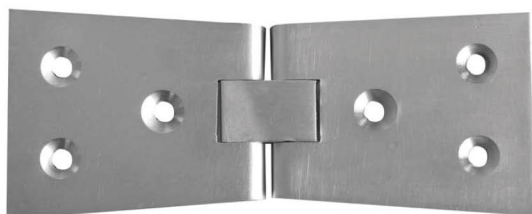

Product code:	Leaf height (mm)	Total width (mm)	Finish
500035	40	100	SC
500033	40	100	PB
500034	40	100	PC

CABINET HINGES

Sold individually

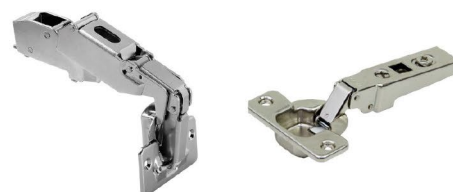

Product code:	Fitting	Opening angle (degrees)
500020	Inset	100
500019	Half overlay	100
500018	Full overlay	100
500022	Half overlay	170
500021	Full overlay	170

MOUNTING PLATE



Sold individually
To suit Mitchells cabinet hinges

Product code: 500023

SOFT CLOSING HINGE



Sold as a pair

Product code: 003882

EASY-ON CABINET HINGE



Length: 105mm
Sold as a pair

Product code: 003881

ARCHITECTURAL IRONMONGERY

HINGES



HINGES

PIANO HINGES

Sold individually
Can be cut to size



Product code:	Total leaf width (mm)	Total length (mm)	Finish:
500015	32	1830	NP
500016	32	1830	EB
500017	35	1830	SS

HINGE REPAIR PLATE



Sold in pairs

Product code: 500024

DOUBLE ACTION PIVOT HINGE SET

Grade 304 stainless steel
Designed to allow door to open outwards in case of emergency
Maximum door weight: 80Kg
For use with 500028 emergency release door stop



Product code: 500027

PIVOT EMERGENCY RELEASE DOOR STOP

Grade 304 stainless steel
Designed to allow the door to open outwards in case of emergency
For use with 500027 square pivot hinge set
Maximum door weight: 80Kg



Product code: 500028

STEEL HINGE BOLTS



Finish: Zinc plated
Sold in pairs

Product code: 003452

ANTIQUE DUMMY HINGES



Size: 400mm
Sold as a pair

Product code: 003818

CABINET HINGE DAMPENER



Sold as a pair

Product code: 003901

HEAVY ANTIQUE HINGES



Size: 300mm
Sold as a pair

Product code: 003816

ANTIQUE HINGES



Size: 290mm
Sold as a pair

Product code: 003817

SMALL ANTIQUE HINGES



Size: 100mm
Sold as a pair

Product code: 003824

ARCHITECTURAL IRONMONGERY

LOCKS



EURO PROFILE DOUBLE CYLINDERS

Tested to BS EN 1303
30/60-minute fire door rated
Anti-drill
Anti-pick
Break off system



EURO PROFILE OFFSET DOUBLE CYLINDERS

Tested to BS EN 1303
30/60-minute fire door rated
Anti-drill
Anti-pick
Break off system

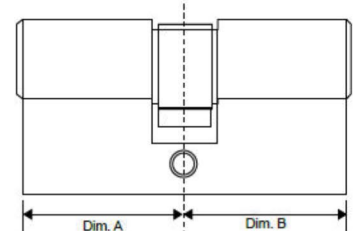

Product code:	Total Length (mm)	Finish:	Thumb turn:
530000	60	SC	No
530001	70	SC	No
530002	80	SC	No
530003	90	SC	No
530004	100	SC	No
530005	60	SC	Yes
530006	70	SC	Yes
530007	80	SC	Yes
530008	90	SC	Yes
530009	100	SC	Yes

Product Code:	Length A (mm)	Length B (mm)	Finish	Thumb turn
530011	30	40	SC	No
530012	30	50	SC	No
530013	30	70	SC	No
530014	35	40	SC	No
530015	35	45	SC	No
530016	35	50	SC	No
530017	35	55	SC	No
530018	40	45	SC	No
530019	40	50	SC	No
530020	40	55	SC	No
530021	40	60	SC	No
530022	45	50	SC	No
530023	45	55	SC	No
530024	30	50T	SC	Yes
530025	30	70T	SC	Yes
530026	35	40T	SC	Yes
530027	35	45T	SC	Yes
530028	35	55T	SC	Yes
530029	40	35T	SC	Yes
530030	40	45T	SC	Yes
530031	40	50T	SC	Yes
530032	40	60T	SC	Yes
530033	45	35T	SC	Yes
530034	45	40T	SC	Yes
530035	50	30T	SC	Yes
530036	50	40T	SC	Yes
530037	60	40T	SC	Yes
530038	70	30T	SC	Yes

KEYED ALIKE CYLINDERS

Tested to BS EN 1303
30/60-minute fire door rated
Anti-drill
Anti-pick
Break off system
All sizes and types available on special order



Product code:	Type:	Size (mm)	Finish:
008765	Euro double	70	SC
008923	Euro cylinder and turn	70	SC
008364	Euro single	45	SC

ARCHITECTURAL IRONMONGERY



LOCKS

MASTER KEYED CYLINDERS

Tested to BS EN 1303
30/60-minute fire door rated
Anti-drill
Anti-pick
Break off system
All sizes and types available on special order



RIM CYLINDER

Tested to BS EN 1303
Break off system



Product codes: SC: 530043 PB: 530042

SCREW-IN CYLINDER SET

Supplied complete with trim rings
Fitted with rear cam for use with mortice type metal door locks
Supplied in keyed-alike pairs complete with 3 keys
Single cylinders also available to special order



Product Code: 530046

Product code:	Type:	Size (mm)	Finish:
008833	Euro double	70	SC
008378	Euro cylinder and turn	70	SC
008912	Euro single	45	SC

DIN STANDARD LOCKS

Tested to BS EN 12209 2003: Grade 3
Larger distance between the spindle and the lock mechanism to increase user comfort
Finish: SSS
'Grip tight' follower
Anti-rattle strike
Bathroom lock contains an 8mm-5mm spindle adaptor
Escape locks allow a door to be unlocked from the inside by a single motion of the door furniture, without the need to turn a bolt
Suitable for 30/60-minute fire doors



Product code:	Lock type:	Backset (mm)	Spindle to lock (mm)	Case width (mm)	Case height (mm)	Forend Type:
520000	Latch	60	-	90	165	S
520075	Latch	60	-	90	165	R
520003	Deadlock	60	-	90	165	S
520074	Deadlock	60	-	90	165	R
520001	Sashlock	60	72	90	165	S
520072	Sashlock	60	72	90	165	R
520004	Escape sashlock	60	72	90	165	S
520076	Escape sashlock	60	72	90	165	R
520002	Bathroom lock	60	78	90	165	S
520073	Bathroom lock	60	78	90	165	R

ARCHITECTURAL IRONMONGERY

LOCKS



BULLET LOCK

To suit the most popular size of roller shutters

Keyed alike

Body length: 35mm

Pin length: 55mm

Profile dimensions: 22 x 15mm



Product Code: 530044

HOUSING FOR BULLET LOCK



Product Code: 530045

UK STANDARD LOCKS

Tested to BS EN 12209:2003 Grade 2
Solid Brass latch and deadbolt
Sintered steel follower
Short travel latch function
Grip tight spring follower
Includes plastic back box
Suitable for 30/60-minute fire doors



Product code:	Lock type:	Backset (mm)	Case width (mm)	Case height (mm)	Spindle to lock (mm)	Finish:
520006	Euro sashlock	44.5	67.5	112	47.5	SSS
520091	Euro sashlock	44.5	67.5	112	47.5	PVD
520007	Euro sashlock	57	79.5	112	47.5	SSS
520092	Euro sashlock	57	79.5	112	47.5	PVD
520008	Euro deadlock	44.5	67.5	80	-	SSS
520093	Euro deadlock	44.5	67.5	80	-	PVD
520009	Euro deadlock	57	79.5	80	-	SSS
008883	Euro deadlock	57	79.5	80	-	PVD
520010	Bathroom lock	44.5	65.5	102	57	SSS
520012	Bathroom lock	44.5	65.5	102	57	PVD
520011	Bathroom lock	57	78	102	57	SSS
520013	Bathroom lock	57	78	102	57	PVD
520014	Oval sashlock	44.5	67.5	112	47.5	SSS
520095	Oval sashlock	44.5	67.5	112	47.5	PVD
520015	Oval sashlock	57	79.5	112	47.5	SSS
520096	Oval sashlock	57	79.5	11.2	47.5	PVD
520016	Oval deadlock	44.5	67.5	80	-	SSS
520097	Oval deadlock	44.5	67.5	80	-	PVD
520017	Oval deadlock	57	79.5	80	-	SSS
520098	Oval deadlock	57	79.5	80	-	PVD
520020	3 lever sashlock	44.5	65.5	102	57	SSS
520022	3 lever sashlock	44.5	65.5	102	57	PVD
520021	3 lever sashlock	57	78	102	57	SSS
520023	3 lever sashlock	57	78	102	57	PVD
520024	3 lever deadlock	44.5	65.5	72	-	NP
520026	3 lever deadlock	44.5	65.5	72	-	PB
520025	3 lever deadlock	57	78	72	-	NP
520027	3 lever deadlock	57	78	72	-	PB



We Cut Keys!

LOCKS

BRITISH STANDARD 5 LEVER LOCKS

BEST SELLER

Complies with BS 3621:2007

Meets the demands of insurance companies and the police

5 lever mechanism

The deadbolt has hardened steel plates to resist drilling and saw attack

Supplied with 2 keys



Product code:	Lock type:	Backset (mm)	Spindle to lock (mm)	Case width (mm)	Case height (mm)	Finish:
520028	Sashlock	44.5	47.5	67.5	110	SC
520029	Sashlock	57	47.5	79.5	110	SC
520032	Deadlock	44.5	-	67.5	90	SC
520033	Deadlock	57	-	79.5	90	SC
520030	Sashlock	44.5	47.5	67.5	110	PB
520031	Sashlock	57	47.5	79.5	110	PB
520034	Deadlock	44.5	-	67.5	90	PB
520035	Deadlock	57	-	79.5	90	PB

UNION MORTICE LOCKS

3 lever locks

Reversible latch bolts

Pierced to accept bolt through furniture (except 50mm sash lock case)

Suitable for use with unsprung lever handles (except 50mm sash lock case)

10 year Guarantee

Tested to BS EN 1634-1

Supplied with 2 Keys







Product code:	Lock type:	Backset (mm)	Case width (mm)	Case height (mm)	Spindle to lock (mm)	Finish:
520054	Sashlock	32	56	109	57	SC
520055	Sashlock	44.5	65	109	57	SC
520056	Sashlock	57	78	109	57	SC
520057	Deadlock	44.5	65	70	-	SC
520058	Deadlock	57	80	70	-	SC

ARCHITECTURAL IRONMONGERY

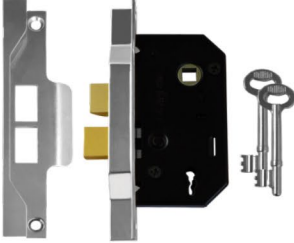
LOCKS



	<p>REBATED SASHLOCK</p>	<p>2 lever lock Reversible latch bolt To suit 13mm rebated wooden doors Universally handed 5 year Guarantee Tested to BS EN 1634-1 Finish: SE Supplied with 2 Keys Backset sizes in stock:</p>	<p>Product code: 44.5mm: 520059 57mm: 520060</p>
	<p>ASSA ESCAPE NIGHTLATCH</p>	<p>Suitable for entrance and exit doors which must lock automatically when the door is closed. The lever handle gives fast, safe exit in an emergency. These locks are also ideal for use with electric strikes in access control applications</p> <p>Uses either Euro or UK Oval profile cylinders</p> <p>Supplied as standard with security box striking plate and square faceplate</p> <p>Hardened steel 13mm latchbolt deadlocks automatically when door is closed</p> <p>Latchbolt reversible without opening lock case</p> <p>Available with 57mm backset</p>	<p>Product code: 520077</p>
	<p>ASSA COMPACT ESCAPE SASH LOCK</p>	<p>Escape sash locks are ideal for residential entrance doors, and comply with BS 5588 Part 1, section 1882 (a) Their simple operation makes them ideal for use by the elderly</p> <p>Uses either Euro or UK Oval profile cylinders</p> <p>Supplied as standard with security box striking plate and square faceplate</p> <p>Hardened steel deadbolt thrown 16mm by internal lever handle or by 360° turn of key. Latch bolt reversible without opening lock case</p> <p>Available with 57mm backset</p> <p>Lock case must be used with a double action handle eg ASSA 3350</p>	<p>Product code: Right hand: 520078 Left hand: 520079</p>
	<p>ASSA SASH LOCK WITH HOOK BOLT</p>	<p>Lock case for classrooms, hotels, technical areas, offices, etc where high security demands and quick and convenient exiting are top priorities</p> <p>Features 50mm backset</p> <p>Complies with the requirements of Swedish Standard SS 3522, class 2</p> <p>With deadlocking lever latch and hook bolt</p> <p>Latch bolt deadlocks automatically when it is extracted 14mm and the deadlocking latch is depressed</p> <p>Handing of the lever latch is reversible</p> <p>Can be fitted with or without outside handle</p> <p>Options in stock:</p>	<p>Product code: Right hand: 520080 Left hand: 520081</p> <p>Outside: Deadbolt is operated with key Latch is retracted with handle</p> <p>Inside: Deadbolt is operated with thumb turn Latch and deadbolt are retracted with the lever handle</p>

ARCHITECTURAL IRONMONGERY



LOCKS

REBATE KITS

Rebate kits allow locking mechanisms to be fitted correctly on rebated double doors

They are brand specific, therefore a rebate kit for a specific lock will not necessarily work with a different lock. The rebate kits we supply suit the locks we also supply



Product code:	Suitable locks	Rebate size (mm)	Finish:
520018	UK standard sashlocks	13	SSS
520019	UK standard deadlocks	13	SSS
520005	DIN standard locks	13	SSS
520036	BS 5 lever sashlocks	13	SC
520037	BS 5 lever sashlocks	13	PB
520038	BS 5 lever deadlocks	13	SC
520039	BS 5 lever deadlocks	13	PB
520082	Union 3L deadlocks	13	SC
520083	Union 3L sashlocks	13	SC

STANDARD TUBULAR LATCH

BEST SELLER

Suitable for commercial and residential use

Bolt through fixings holes to suit lever on rose furniture



Product code:	Backset (mm)	Finish:
520046	45	SZ
520062	45	PB
520047	57	SZ
520063	57	PB

ARCHITECTURAL TUBULAR LATCH



Tested to BS EN 1634-1
Tubular bolt through latch
Guided latch bolt
Adjustable strike
Finish: SSS
Backset sizes in stock:

Product code:
45mm: 520068 57mm: 520069

REBATED TUBULAR LATCH



To suit double doors with rebated meeting edges
Rebate size: 13mm
Finish: SC
Backset sizes in stock:

Product code:
44mm: 520087 57mm: 520088

REBATE KITS TO SUIT TUBULAR LATCHES



To suit double doors with rebated meeting edges
Rebate size: 13mm
To suit our standard tubular latch range
Finishes in stock:

Product code:
SC: 520065 PB: 520064

ARCHITECTURAL IRONMONGERY

LOCKS



BRASS FACEPLATE FOR ARCHITECTURAL TUBULAR LATCH



Product code: 520084

RADIUS ACCESSORY PACK FOR ARCHITECTURAL TUBULAR LATCH



Product code:
SS: 520085 PVD: 520099

UNION EXTENDED TUBULAR LATCH



Finish: SE
Backset: 71.5mm
Total length: 91.5mm

Product code: 520086

UNION TUBULAR LATCH REBATE KIT



Rebate size: 13mm
To suit Union tubular latches & digital locks
Finish: SC

Product code: 520089

ARCHITECTURAL TUBULAR DEAD BOLT



Standalone deadbolt for locking doors
Finish: SSS
Tested to BS EN: 1634-1
Backset sizes in stock:

Product code:
44mm: 520070 57mm: 520071

BRASS COVER PLATES



To suit architectural tubular deadbolt

Product code: 520090

EXTENDED STRIKE PLATE

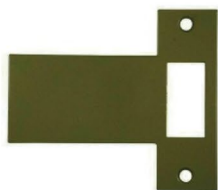

Total length: 100mm

Product code: 009636

ADJUSTABLE ROLLER BOLT CATCHES

Suitable for push/pull doors



Product code:

Size (mm)

Finish:

570029

59 x 25

SN

570030

59 x 25

PB

570031

45 x 32

SSS

570032

45 x 32

SB

ARCHITECTURAL IRONMONGERY





LOCKS

FLAT LATCH					
Finish: SSS 	Product code	Backset (mm)	Case width (mm)	Case height (mm)	Forend length (mm)
	520066	44.5	67.5	60	125
	520067	57	79.5	60	125

RIM NIGHTLATCH				
Non-deadlocking nightlatch Bolt can be locked from inside with snib Supplied with 5-pin cylinder and 3 keys Suitable for timber doors 35-55mm thick 	Product code:	Finish:	Backset (mm)	Case Size (mm)
	520040	SCP	40	62 x 70
	520041	Electro-Brass	40	62 x 70
	520042	SCP	60	92 x 70
	520043	Electro Brass	60	92 x 70

STANDARD NIGHTLATCH
 <p>Finish: Champagne Sizes in stock:</p>
<p>Product code: 40mm: 003586 60mm: 003585</p>

STANDARD NIGHTLATCH
 <p>Finish: Polished chrome Size: 60mm</p>
<p>Product code: 003587</p>

UNION MORTICE NIGHTLATCH
 <p>Reversible latch bolt Accepts UK Oval single cylinder (supplied separately) Case width's in stock:</p>
<p>Product code: 64mm: 520051 76mm: 520052</p>

OPERATING KNOB
 <p>To suit Union mortice nightlatch</p>
<p>Product code: 520053</p>

ARCHITECTURAL IRONMONGERY

LOCKS



DOUBLE LOCKING NIGHTLATCH



Product code:	Finish:	Backset (mm)
003579	PB	60
003580	PB	40
003577	PC	60
003578	PC	40
003581	Silver	60
003582	Silver	40
003583	White	60
003584	White	40

PRESS LOCK



Size: 75mm

Product code: 003592

RIM LATCH WITH SNIB



Size: 100mm

Product code: 003593

DOUBLE HANDED RIM LOCK



Size: 140mm

Product code: 003590

DOUBLE HANDED RIM LOCK - WITH FLANGE



Size: 150mm
Finishes in stock:

Black: 003589
PB: 003588 PC: 003594

DOUBLE HANDED RIM DEADLOCK



Size: 100mm

Product code: 003591

DOUBLE HANDED RIM LOCK



Size: 100mm
Finish: Brass

Product code: 003449

ARCHITECTURAL IRONMONGERY



We Cut Keys!

LOCKS

CAMLOCK			
<p>Nut fixed Supplied with 2 keys 180 degree clockwise movement 5-pin mechanism Rose diameter: 22.5mm Body height 18mm Cam bar 35mm</p>	Product code:	Keying type:	Body length (mm)
	520100	To Differ	16
	520101	Keyed Alike	16
	520102	To Differ	20
	520103	Keyed Alike	20
	520104	To Differ	22
	520105	Keyed Alike	22
	520106	To Differ	27
	520107	Keyed Alike	27
	520108	To Differ	32
520109	Keyed Alike	32	

DRAWER/CABINET LOCK - TWIN FIXING BACKPLATE

Pedestal lock for drawers/cabinets
180 degree lock/unlock
Supplied with 2 keys

Product code: 520110

DRAWER/CABINET LOCK - SINGLE FIXING BACKPLATE

Pedestal lock for drawers/cabinets
180 degree lock/unlock
Supplied with 2 keys

Product code: 520111

FURNITURE LOCK

Furniture lock for wooden furniture
Supplied with 2 keys
Body diameter: 38mm
Cylinder diameter: 16.3mm
Cylinder length: 19mm

Product code: 520112

DRAWER LOCK

Size: 63mm
Finish: Brass
2 keys included

Product code: 003575

CUPBOARD LOCK

Size: 63mm
Finish: Brass
2 keys included

Product code: 003574

ARCHITECTURAL IRONMONGERY

LOCKS



BEST SELLER		<p>STANDARD DIGITAL LOCK</p>	<p>1000+ combinations Internal and external applications Simple installation Optional hold-back Suitable for 35-60mm thick doors Supplied with tubular latch and fittings Finish: SC</p>	<p>Product code: 520045</p>
--------------------	---	-------------------------------------	--	---

	<p>PREMIUM DIGITAL LOCK</p>	<p>Reversible latch Optional hold-back Fire rated when fitted with suitable intumescent packing Protective clutch mechanism Suits 35 - 65mm thick doors Weather resistant PVD Supplied with mortice latch and fittings Finish: SSS</p>	<p>Product code: 520044</p>
--	------------------------------------	--	---

	<p>RIM BUDGET LOCK</p>	<p>Can be used for securing panels, meter cupboards, store cupboards, lamp post panels and other applications Locking device for securing doors where high security is not required Can also be used in multiple quantities for securing all types of doors Finish: BZP T-Key required for opening Dimensions: 80 x 20mm</p>	<p>Product code: 540027</p>
---	-------------------------------	--	---

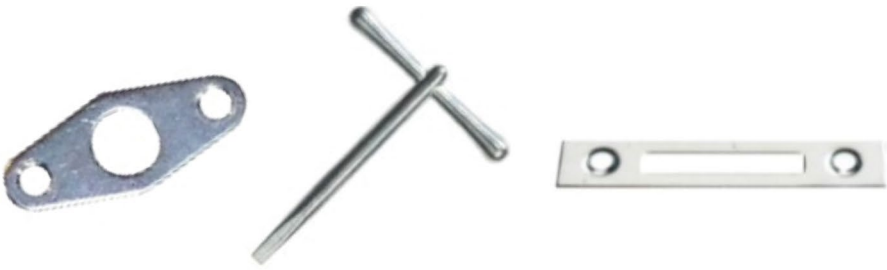
BUDGET LOCK ACCESSORIES		
		
Product code:	Description:	Finish:
540028	T-Key	BZP
540029	Slotted flat keep plate	BZP
540030	Escutcheon plate	BZP

DORMAKABA DIGITAL LOCK

<p>Reversible latch Non-handed unit Protective clutch mechanism Fast code change whilst unit fitted Suits doors 35 - 57mm thick Adjustable backset Weather resistant Finish: SC</p>
<p>Product code: 008146</p>

ARCHITECTURAL IRONMONGERY

PANIC HARDWARE



PANIC HARDWARE

REVERSIBLE PANIC LATCH



Tested to BS EN: 1255
Universally handed
Surface mounted
Adapter supplied for operating with a rim cylinder
Certifire rated
Finish: Silver

Product code: 560002

REVERSIBLE PANIC BOLT



Tested to BS EN: 1255
Universally handed
Surface mounted
Adapter supplied for operating with a rim cylinder
Certifire rated
Finish: Silver

Product code: 560001

REBATED DOUBLE DOOR ESCAPE SET



Tested to BS EN: 1255
Universally handed
Surface mounted
Adapter supplied for operating with a rim cylinder
Certifire rated
Finish: Silver

Product code: 560000

REVERSIBLE PUSH PAD PANIC LATCH



Tested to BS EN: 1255
Universally handed
Surface mounted
Adapter supplied for operating with a rim cylinder
Certifire rated
Finish: Silver

Product code: 560003

LEVER OPERATED OUTSIDE ACCESS DEVICE

Universally handed
Meets the dimensional
requirements of BS 8300
and approved Document M

Lever is supplied with
special shear screw designed
to break under excessive force

Surface mounted on the
outside of the door using
three concealed machine screws

Same fixing points as the knob operated
OAD - easy retro fit

Supplied as standard for doors up to 55mm thick

Longer spindles available on request for door
thicknesses over 55mm

Finish: Silver



Product code: 560004

KNOB OPERATED OUTSIDE ACCESS DEVICE

Universally handed

Fire rated for use on
timber and steel doors

Surface mounted on the
outside of the door using
concealed machine screws

Supplied as standard for
doors up to 45mm thick

Longer spindles and screws
are available on request for
door thicknesses over 45mm

Finish: Silver



Product code: 560005

REDLAM BREAK GLASS BOLT

Designed to produce no sharp
edges when smashed
Breaking the Ceramtube results
in the bolt sliding back automatically
and unlocking the door

Designed for interconnecting
emergency exit doors

Supplied complete with
hammer and chain



Product code: 560007
Extra ceramic tubes available: 560008

DOUBLE DOOR STRIKE PLATE



For use on panic hardware for double rebated doors

Product code: 008887

ARCHITECTURAL IRONMONGERY

IRONMONGERY ACCESSORIES

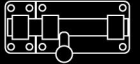

IRONMONGERY
ACCESSORIES

STANDARD DOOR BOLT

	Product code:	Size (mm)	Finish:
	003537	38	PB
003538	50	PB	
003539	63	PB	
003540	75	PB	
003541	100	PB	
003542	150	PB	
003546	38	PC	
003547	50	PC	
003548	63	PC	
003549	75	PC	
003550	100	PC	
003551	150	PC	
003556	38	SAA	
003557	50	SAA	
003558	63	SAA	
003559	75	SAA	
003560	100	SAA	
003561	150	SAA	

HEAVY DOOR BOLT

	Product code:	Size (mm)	Finish:
	003534	100	PB
003535	150	PB	
003536	200	PB	
003553	100	PC	
003554	150	PC	

NECKED DOOR BOLT

	Product code:	Size (mm)	Finish:
	003543	75	PB
003544	100	PB	
003545	150	PB	
003552	75	PC	
003562	75	SAA	
003563	100	SAA	

ARCHITECTURAL STRAIGHT BARREL BOLT

	Product code:	Size (mm)	Finish:
	540007	152 x 32	SC
540008	152 x 38	SC	
540011	200 x 32	SC	
540012	200 x 38	SC	
540005	152 x 25	PB	
540006	152 x 32	PB	
540032	152 x 38	PB	

ARCHITECTURAL NECKED BOLT

	Product code:	Size (mm)	Finish:
	540009	152 x 32	SCP
540010	152 x 38	SCP	
540031	152 x 32	PB	
540026	152 x 38	PB	

ARCHITECTURAL SLIDE BOLT

	Product code:	Size (mm)	Finish:
	540003	152 x 35	SC
540004	152 x 35	PB	

BRASS FLUSH BOLT

Sizes in stock:	
Product code: 100mm: 003686 150mm: 003687	

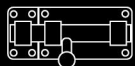

ARCHITECTURAL IRONMONGERY

IRONMONGERY ACCESSORIES



IRONMONGERY
ACCESSORIES

BEST SELLER 	FLUSH BOLT	Grade 304 SSS Bolt diameter: 11mm Bolt throw: 15mm Supplied with screws & flat receiver plate - Easyclean socket available separately	Product Code:	Size (mm)	Finish
			540000	150 x 20	SSS
			540001	200 x 20	SSS
			540002	13 (Easyclean Socket)	SC

SECURITY BOLT					WHITE SECURITY BOLT
	Product Code:	Length (mm)	Backset (mm)	Finish	 Size: 55mm Product code: 003475
	540013	37	17	EB	
	540014	37	17	PC	
	540015	37	17	SC	
	540016	61	32	EB	
	540017	61	32	PC	
	540018	61	32	SC	

OVAL THUMBTURN FOR SECURITY BOLT		
 Suitable for 61mm security bolt	Product Code:	Finish:
	540019	PB
	540020	PC
	540021	SC

SECURITY BOLT KEY

Product code: 540022

SECURITY BOLT KEY

Product code: 003478

INDICATOR BOLT			
	Product Code:	Size(mm)	Finish:
	540023	65 x 40mm	PB
	540024	65 x 40mm	PC
	540025	65 x 40mm	SC

ANTIQUE DOOR BOLT
 Sizes in stock:
Product code: 150mm: 003825 200mm: 003826

ANTIQUE DOOR BOLT - CURLY TAILED
 Size: 100mm
Product code: 009624

ARCHITECTURAL IRONMONGERY

IRONMONGERY ACCESSORIES

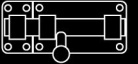

IRONMONGERY
ACCESSORIES

<p>LOCKING DOOR CHAIN</p>  <p>Size: 110mm Finishes in stock:</p> <p>Product code: Brass: 003566 PC: 003567</p>		<p>NARROW DOOR CHAIN</p>  <p>Size: 44mm Finishes in stock:</p> <p>Product code: Brass: 003568 PC: 003569</p>		<p>LION HEAD KNOCKER</p>  <p>Sizes in stock:</p> <p>Product code: 100mm: 003456 150mm: 003639</p>															
		<p>STANDARD DOOR CHAIN</p>		<p>Plate size: 84 x 35mm Chain retainer size: 52 x 20mm Chain length: 200mm</p> <table border="1"> <thead> <tr> <th>Product Code:</th> <th>Finish</th> </tr> </thead> <tbody> <tr> <td>570021</td> <td>PB</td> </tr> <tr> <td>570022</td> <td>PC</td> </tr> <tr> <td>570023</td> <td>SC</td> </tr> </tbody> </table>		Product Code:	Finish	570021	PB	570022	PC	570023	SC						
Product Code:	Finish																		
570021	PB																		
570022	PC																		
570023	SC																		
<p>VICTORIAN URN DOOR KNOCKER</p>  <table border="1"> <thead> <tr> <th>Product Code:</th> <th>Finish:</th> <th>Size (mm)</th> </tr> </thead> <tbody> <tr> <td>003637</td> <td>Brass</td> <td>125</td> </tr> <tr> <td>003638</td> <td>Brass</td> <td>150</td> </tr> <tr> <td>003735</td> <td>PC</td> <td>150</td> </tr> </tbody> </table>				Product Code:	Finish:	Size (mm)	003637	Brass	125	003638	Brass	150	003735	PC	150	<p>DOOR VIEWER - 160 DEGREES</p>  <p>Viewing angle: 160 degrees Finishes in stock:</p> <p>Product code: Brass: 003570 PC: 003571</p>		<p>VICTORIAN SLIM KNOCKER</p>  <p>Size in stock: 200mm</p> <p>Product code: 003649</p>	
Product Code:	Finish:	Size (mm)																	
003637	Brass	125																	
003638	Brass	150																	
003735	PC	150																	
<p>DOOR VIEWER - 180 DEGREES</p>  <p>Diameter: 14mm Suitable for door thickness 35 - 55mm</p> <table border="1"> <thead> <tr> <th>Product Code:</th> <th>Finish:</th> </tr> </thead> <tbody> <tr> <td>570024</td> <td>PB</td> </tr> <tr> <td>570025</td> <td>PC</td> </tr> <tr> <td>570026</td> <td>SC</td> </tr> </tbody> </table>				Product Code:	Finish:	570024	PB	570025	PC	570026	SC	<p>FOX HEAD KNOCKER</p>  <p>Size in stock: 150mm</p> <p>Product code: 003646</p>							
Product Code:	Finish:																		
570024	PB																		
570025	PC																		
570026	SC																		

ARCHITECTURAL IRONMONGERY

IRONMONGERY ACCESSORIES

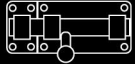

IRONMONGERY
ACCESSORIES

**We Cut
Keys!**

GEORGIAN URN KNOCKER



Sizes in stock:

Product code:
165mm: 003607 200mm: 003608

ANTIQUE LION DOOR KNOCKER



Size: 150mm

Product code: 003819

ANTIQUE RING HANDLE KNOCKER



Size: 125mm

Product code: 003820

VICTORIAN CYLINDER PULL



Size: 75mm
Finishes in stock:

Product code:
Brass: 003641 PC: 003736

ANTIQUE CYLINDER PULL



Size: 125mm

Product code: 003821

ALUMINIUM ESCUTCHEON



Size: 30mm

**Product code: Open: 008574
Covered: 008575**

COMMERCIAL CYLINDER PULL



Product Code:	Type:
550046	Standard keyway
550047	Euro profile
550048	Round rim cylinder
550049	Blank pull

VICTORIAN ESCUTCHEON



Product code:	Type:	Finish:
003644	Open	Brass
003643	Covered	Brass
003739	Open	PC
003738	Covered	PC

ARCHITECTURAL IRONMONGERY

IRONMONGERY ACCESSORIES

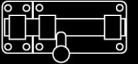

IRONMONGERY
ACCESSORIES

VICTORIAN BELL PUSH



Size: 75mm
Finishes in stock:

Product code:
PB: 003642 PC: 003737

ANTIQUE ESCUTCHEON



Sold as a pair
Size: 75mm

Product code: 003823

ANTIQUE BELL PUSH



Size: 120mm

Product code: 003820

GEORGIAN BELL PUSH



Size: 75mm

Product code: 003611

INTERNAL LETTER FLAP



Size: 280 x 75mm
Finishes in stock:

Product code:
Brass: 003634 PC: 003734

GEORGIAN LETTER PLATE



Sizes in stock:

Product code:
250mm: 003604 275mm: 003605

VICTORIAN GRAVITY LETTER PLATE



Size: 250 x 75mm

Product code: 003633

VICTORIAN LETTER PLATE WITH KNOCKER



Size: 250 x 75mm
Finishes in stock:

Product code:
Brass: 003632 PC: 003732

SHAPED LETTER PLATE



Size: 300mm
Finish: PC

Product code: 003733

ARCHITECTURAL IRONMONGERY

IRONMONGERY ACCESSORIES

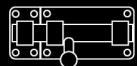

IRONMONGERY
ACCESSORIES

VICTORIAN LETTER PLATE

	Product code:	Size (mm)	Finish
	003629	250 x 76	Brass
	003731	250 x 76	PC
	003630	254 x 100	Brass
	003631	355 x 115	Brass

BRUSH LETTER BOX COVER



Size: 300mm
Colours in stock:

Product code:
White: 003444 Brown: 003445

ANTIQUE LETTER PLATE



Size: 250mm

Product code: 003814

ANTIQUE LETTER PLATE - PATTERNED



Size: 350mm

Product code: 003815

DOUBLE SIDED LETTER PLATE



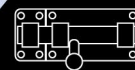

	Product code:	Door Thickness	Colour:
	003773	20 - 40	Silver
	003774	20 - 40	Gold
	003775	20 - 40	White
	003776	40 - 80	Silver
	003777	40 - 80	Gold
	003778	40 - 80	White

ARCHITECTURAL IRONMONGERY

IRONMONGERY ACCESSORIES



IRONMONGERY
ACCESSORIES

DOOR NUMBERS & LETTERS					
	Product code:	Number/letter	Height (mm)	Finish:	
	003657	0	50	Brass	
	003658	1	50	Brass	
	003659	2	50	Brass	
	003660	3	50	Brass	
	003661	4	50	Brass	
	003662	5	50	Brass	
	003663	6	50	Brass	
	003664	7	50	Brass	
	003665	8	50	Brass	
	003666	9	50	Brass	
	003667	A	50	Brass	
	003668	B	50	Brass	
	003669	0	75	Brass	
	003670	1	75	Brass	
	003671	2	75	Brass	
	003672	3	75	Brass	
	003673	4	75	Brass	
	003674	5	75	Brass	
	003675	6	75	Brass	
	003676	7	75	Brass	
	003677	8	75	Brass	
	003678	9	75	Brass	
	003679	A	75	Brass	
	003680	B	75	Brass	
					

DOOR NUMBERS & LETTERS				
Product code:	Number/letter	Height (mm)	Finish:	
003855	0	50	PC	
003856	1	50	PC	
003857	2	50	PC	
003858	3	50	PC	
003859	4	50	PC	
003860	5	50	PC	
003861	6	50	PC	
003862	7	50	PC	
003863	8	50	PC	
003864	9	50	PC	
003865	A	50	PC	
003866	B	50	PC	
003749	0	75	PC	
003750	1	75	PC	
003751	2	75	PC	
003752	3	75	PC	
003753	4	75	PC	
003754	5	75	PC	
003755	6	75	PC	
003756	7	75	PC	
003757	8	75	PC	
003758	9	75	PC	
003747	A	75	PC	
003748	B	75	PC	

ANTIQUÉ NUMERALS			
	Product code:	Number/letter	Height (mm)
	003830	0	75
	003831	1	75
	003832	2	75
	003833	3	75
	003834	4	75
	003835	5	75
	003836	6	75
	003837	7	75
	003838	8	75
	003839	9	75

SILENT CABIN HOOK			
	Product code:	Size (mm)	Finish:
	003688	75	Brass
	003689	100	Brass
	003690	150	Brass
	003691	200	Brass
	003692	250	Brass
	003759	100	PC
	003760	150	PC

ARCHITECTURAL IRONMONGERY

IRONMONGERY ACCESSORIES

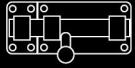

IRONMONGERY
ACCESSORIES

BRASS SUFFOLK LATCH SET



Size: 200mm

Product code: 003684

ANTIQUE SUFFOLK LATCH



Size: 200mm

Product code: 006478

BRASS CABIN HOOK



Sizes in stock:

Product code:
75mm: 003693
100mm: 003694

PROJECTION DOOR STOP



Product code:	Size (mm)	Finish:
003702	63	Brass
003703	75	Brass
003767	63	PC

CONCEALED PROJECTION DOOR STOP



Size: 63mm

Product code: 003704

OVAL DOOR STOP



Size: 50mm
Finishes in stock:

Product code:
Brass: 003700 PC: 003766

BRASS SHIELDED DOOR STOP



Size: 38mm

Product code: 003699

SPRING DOOR STOP



Size: 75mm

Product code:
Brass: 003701 Chrome: 003768

COMMERCIAL OVAL DOOR STOP

BEST
SELLER



Finish: SSS
Diameter: 40mm
Height: 24mm

Product code: 570011

BLACK RUBBER DOOR STOP



Diameter: 32mm
Height: 27mm

Product code: 570014

ARCHITECTURAL IRONMONGERY

IRONMONGERY ACCESSORIES

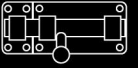

IRONMONGERY
ACCESSORIES

COMMERCIAL PROJECTION DOOR STOP

**BEST
SELLER**



Finish: SSS
Length: 75mm
Rose diameter: 37mm

Product code: 570012

COMMERCIAL SHIELDED DOOR STOP



Finish: SAA
Diameter: 35mm
Height: 30mm

Product code: 570013

ANTIQUE COAT HOOK



Sold as a pair
Size: 50mm

Product code: 003827

HAT AND TWIN ROBE HOOK



Size: 125mm
Finishes in stock:

Product code:
Brass: 003695 PC: 003762

HANDRAIL BRACKETS



Product code:	Size (mm)	Finish
003886	63	BZP
003779	63	Aluminium
003705	63	Brass
003761	63	PC
570019	63	White
570020	75	White
570017	63	SC
570018	75	SC

CHROME HOOKS ON PINE PLAQUE



Size: 220mm

Product code: 003923

COMMERCIAL HAT & COAT HOOK



Finish: SSS
Dimensions: 177 x 20mm
Projection: 42mm

Product code: 570000

COMMERCIAL ROBE HOOK



Finish: SSS
Dimensions: 70 x 20mm
Projection: 42mm

Product code: 570001

ARCHITECTURAL IRONMONGERY

IRONMONGERY ACCESSORIES

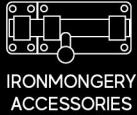

**We Cut
Keys!**

BUFFERED HAT & COAT HOOK



Finish: SSS
Dimensions: 110 x 20mm
Projection: 44mm

Product code: 570002

CONTRACT HAT & COAT HOOK



Finish: SAA
Dimensions: 125 x 20mm

Product code: 570003

CONTRACT ROBE HOOK



Finish: SAA
Dimensions: 50 x 20mm

Product code: 570004

DOMESTIC ROBE HOOK



Product Code:	Size (mm)	Finish:
570005	44mm	PB
570008	44mm	PC

FANLIGHT CATCH



Size: 65mm
Finishes in stock:

Product Code:
Brass: 003709
PC: 003772

DOMESTIC HAT & COAT HOOK



Product Code:	Size (mm)	Finish:
570007	142mm	PB
570010	142mm	PC

CUPBOARD TURN



Size: 50mm
Finish: Brass plated

Product code:
003903

DOMESTIC DOUBLE ROBE HOOK



Product Code:	Size (mm)	Finish
570006	53mm	PB
570009	53mm	PC

CABINET BOLT



Size: 63mm
Finishes in stock:

Product Code:
PC : 003454
Brass: 003555

FLUSH RING HANDLE





Finish: Brass
Sizes in stock:

Product Code:
50mm: 003715
63mm: 003716

ARCHITECTURAL IRONMONGERY

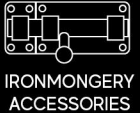
IRONMONGERY ACCESSORIES





CLEAT HOOK			
	Product code:	Size (mm)	Finish:
	003769	75	Chrome
	003885	90	ZP
	003448	90	Black
	003884	110	Black

Sold individually

COUNTERFLAP CATCH		
	Product Code:	Finish:
	570033	PB
	570034	PC
	570035	SC

CHROME TUBE			
	Product Code:	Diameter (mm)	Length (mm)
	003915	19	600
	003916	19	900
	003917	19	1200
	003918	19	1500
	003919	19	1800
	003920	25	1200
	003921	25	1500
	003922	25	1800

RAIL BRACKETS - END SOCKET		
	Sold as pair Finish: Chrome Sizes in stock:	Product Code: 19mm: 003911 25mm: 003914

RAIL BRACKETS - END		
	Sold as a pair Finish: Chrome Sizes in stock:	Product Code: 19mm: 003910 25mm: 003913

RAIL BRACKETS - CENTRE		
	Finish: Chrome Sizes in stock	Product Code: 19mm: 003909 (sold as a pair) 25mm: 003912 (sold individually)

GEORGIAN BOW HANDLE		
	Sold individually Sizes in stock:	Product Code: 125mm: 003601 180mm: 003600

GEORGIAN PULL HANDLE		
	Sold individually Sizes in stock	Product Code: 125mm: 003602 165mm: 003603

VICTORIAN BOW HANDLE		
	Sold individually Sizes in stock:	Product Code: 150mm: 003623 175mm: 003624

ARCHITECTURAL IRONMONGERY

IRONMONGERY ACCESSORIES

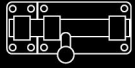



IRONMONGERY
ACCESSORIES

VICTORIAN PULL HANDLE		
	Sold individually Sizes in stock:	Product Code: 125mm: 003627 165mm: 003628

SHAKER HANDLE		
	Surface fixed Size: 96mm Sold as pair Finish: SC	Product Code: 003854

DRAWER PULL		
	Sold individually Size: 90mm Finish: Brass	Product Code: 003719

CUPBOARD D HANDLES		
	Sold as a pair Size: 95mm Surface fixed Finishes in stock:	Product Code: Brass: 003945 Chrome: 003946

ROUND CUPBOARD KNOB		
	Size: 30mm Sold as pair Finishes in stock:	Product Code: PC: 003848 SN: 003849

TOUCH LATCH		
	BZP	Product Code: 003902

VICTORIAN CUPBOARD KNOB			
	Product code:	Finish:	Size (mm)
	003710	Brass	20
	003711	Brass	25
	003712	Brass	30
	003713	Brass	35
Sold as pairs (003714 sold individually)			
003714	Brass	45	

OVAL CUPBOARD KNOB		
	Product Code:	Finish:
	003845	Polished chrome
	003846	Polished brass
Size: 35 mm Sold as pair		
003847	Brushed nickel	

BALL CUPBOARD KNOB		
	Product Code:	Finish:
	003842	PC
	003843	PB
Size: 25mm Sold as pair		
003844	SN	

PINE CUPBOARD KNOB		
	Product Code:	Size (mm)
	003850	30
	003851	35
	003852	40
Size: 35 mm Sold as pair		
003853	48	

ARCHITECTURAL IRONMONGERY

IRONMONGERY ACCESSORIES

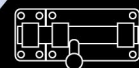

IRONMONGERY
ACCESSORIES

BALL BEARING DRAWER SLIDES			ROSE PACK FOR PULL HANDLES			
	Sold as pair Size: 350mm BZP	Product Code: 003907		Adapts commercial bolt-through pull handles to face-fixing Finishes in stock:	Product Code: SAA: 550293 SSS: 550050	
ALUMINIUM PULL HANDLE			BACK TO BACK FIXING KIT			
	Sold individually Bolt through Sizes in stock:	Product Code: 100mm: 003782 150mm: 003783		Suitable for commercial pull handles Finish: SSS	Product Code: 550051	
ALUMINIUM FLUSH PULL			COMMERCIAL PULL HANDLE			
	Size: 90mm	Product Code: 003784		Product code:	Size (mm)	Finish:
				550026	225 x 19	SSS
				550027	300 x 19	SSS
				550028	425 x 19	SSS
				550030	225 x 19	SAA
				550031	300 x 19	SAA
BRASS FLUSH PULL				550032	425 x 19	SAA
	Size: 90mm	Product Code: 003718	Sold individually Bolt through fixing BS EN1634-1 Grade 201 stainless steel			

ARCHITECTURAL IRONMONGERY

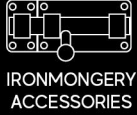



FRELAN
HARDWARE

The name of quality
architectural hardware

IRONMONGERY ACCESSORIES

OVAL GRIP PULL HANDLE			
	Product code:	Size (mm)	Finish:
	550035	225	SAA
	550036	300	SAA
	003682	225	PB

BOW HANDLE		
	Finish: SAA Size: 150mm	Product Code: 550296

COMMERCIAL PULL HANDLE ON BACKPLATE			
	Product code:	Back plate dimensions (mm)	Finish:
	550038	305 x 75	SAA
	550037	375 x 75	SAA
	550040	305 x 75	SSS
	550039	375 x 75	SSS

COMMERCIAL TOILET ROLL HOLDER		
	Finish: SSS Frame Size: 128 x 20mm Projection: 81.5mm	Product Code: 570036

CONTRACT TOILET ROLL HOLDER		
	Size: 135mm Colours in stock:	Product Code: Aluminium: 003780 White: 003781

GRAB RAIL			
	Product code:	Size (mm)	Finish:
	550300	305 x 35	Powder coated white
	550301	450 x 35	Powder coated white
	550302	600 x 35	Powder coated white

LOUVRED VENTS			
	Product Code:	Dimensions (inches)	Finish:
	003789	9 x 3	AL
	003790	9 x 6	AL
	003791	9 x 9	AL
	003792	24 x 3	AL
	003793	9 x 6	Gold
	003801	9 x 3	White plastic
	003802	9 x 6	White plastic
	003803	9 x 9	White plastic

COMMERCIAL FACE-FIXED PULL HANDLE			
	Product code:	Size (mm)	Finish:
	550033	225 x 19	SAA
	550034	305 x 19	SAA

ARCHITECTURAL IRONMONGERY

IRONMONGERY ACCESSORIES

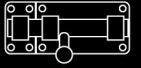

IRONMONGERY
ACCESSORIES

TWIN SLOT ROD BOOKEND



Supplied in pairs
Height: 120mm
Projection: 150mm

Product code: 570052

FINGER KEEPER



Length: 1960mm
Prevents finger trapping accidents in doors
Full fitting kit included
Easily removed and re-fitted to allow door maintenance
Colours in stock:

Product code: White: 570028 Brown: 570027

TWIN SLOT SHELVING

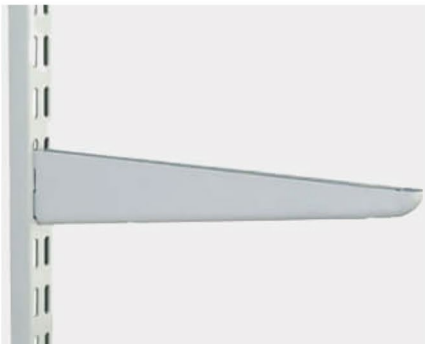

Strong and sturdy twin slot shelving system
Bacteria, fungus & mould resistant coating
Twinslot pitch: 32mm
Sold individually
Finish: White

UPRIGHTS

Product Code:	Height (mm)
570037	430
570038	710
570039	1000
570040	1220
570041	1600
570042	1980

SHELVING BRACKETS

Product Code:	Projection (mm)
570044	120
570045	170
570046	220
570047	270
570048	320
570049	370
570050	470

HIT AND MISS VENTS

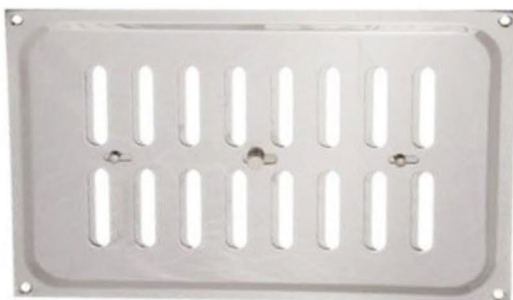

Product Code:	Dimensions (inches)	Finish:
003794	9 x 3	AL
003795	9 x 6	AL
003796	9 x 9	AL
003797	9 x 3	Gold
003798	9 x 6	Gold
003801	9 x 3	White plastic
003802	9 x 6	White plastic
003803	9 x 9	White plastic

ARCHITECTURAL IRONMONGERY

SIGNAGE



SIGNAGE

**We Cut
Keys!**

STAINLESS STEEL SIGNAGE

Diameter: 76mm BS EN 1634-1 Screw fixing Finish: Satin stainless steel						
	Product Code: 580006	Product Code: 580004	Product Code: 580003	Product Code: 580005	Product Code: 580008	Product Code: 580007

STAINLESS STEEL SIGNAGE

Diameter: 76mm BS EN 1634-1 Screw fixing Finish: Satin stainless steel					
	Product Code: 580002	Product Code: 580001	Product Code: 580000	Product Code: 008885	Product Code: 008881

SELF-ADHESIVE PVC SIGNAGE

Size: 300 x 200mm					
	Product Code: 580010	Product Code: 580012	Product Code: 580009	Product Code: 580011	Product Code: 580013

RIGID PVC SIGNAGE

Non-adhesive			
	Product code: 580016 Size: 800 x 600mm	Product code: 006784 Size: 600 x 400mm	Product code: 006289 Size: 600 x 400mm

ARCHITECTURAL IRONMONGERY

SIGNAGE



SIGNAGE

RIGID PVC SIGNAGE					
Non-adhesive					
	Product code: 006279 Size: 200 x 300mm	Product code: 006198 Size: 200 x 300mm	Product code: 006315 Size: 200 x 300mm	Product code: 006312 Size: 200 x 300mm	

RIGID PVC SIGNAGE			
Non-adhesive			
	Product code: 006734 Size: 200 x 300mm	Product code: 580014 Size: 600 x 100mm	Product code: 006512 Size: 300 x 100mm



RIGID PVC SIGNAGE			
Non-adhesive			
	Product code: 009949 Size: 200 x 300mm	Product code: 009950 Size: 200 x 300mm	Product code: 009951 Size: 200 x 300mm

ARCHITECTURAL IRONMONGERY

SLIDING DOOR HARDWARE

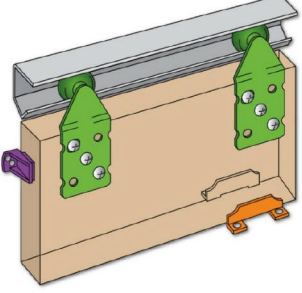

SLIDING DOOR
HARDWARE

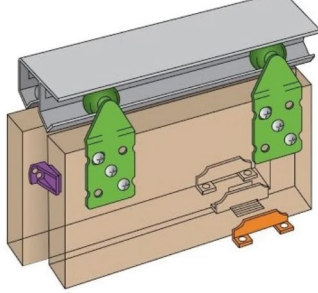
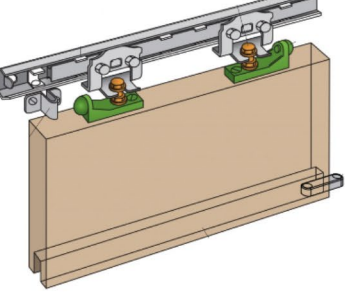

	<p>MORTICE HOOK LOCK</p>	<p>Suitable for 35-45mm thick doors Rose diameter: 60mm Edge pull diameter: 29mm Lock case width: 70mm Lock case backset: 50mm Hook bolt throw: 17mm</p>	<p>Product code:</p> <p>610000 610001 610002</p>	<p>Finish:</p> <p>PB PC SC</p>
	<p>SLIDING DOOR GEAR - SINGLE TRACK TOP HUNG</p>	<p>Single track for doors up to 45kg Max leaf width: 900mm Door thickness: 16-40mm Ideal for wardrobe doors</p>	<p>Product code: 610003</p>	
	<p>SLIDING DOOR GEAR - DOUBLE TRACK BOTTOM ROLLER</p>	<p>Double track for doors up to 23kg Max leaf width 900mm Door thickness 20-45mm Ideal for cupboards, bookcases and wardrobe doors</p>	<p>Product code: 1200mm track length: 610004 1800mm track length: 610005</p>	
	<p>SLIDING DOOR GEAR - DOUBLE TRACK TOP HUNG</p>	<p>Double track for doors up to 45kg Max leaf width 900mm Door thickness 16-40mm Ideal for bi-passing heavy duty cupboards, and wardrobe doors</p> <p>* Fittings kit available for additional door - Product Code: 610008</p>	<p>Product code: 1200mm track length: 610006 1800mm track length: 610007</p>	
	<p>TOP HUNG BALL BEARING GEAR</p>	<p>Single track for doors up to 55kg One-piece ball cage design Door thickness 16-40mm Smooth running and ideal for partitions</p> <p>Note: Unable to be cut down</p> <p>3 Sizes held in stock for various door widths</p>	<p>Product code: 750-900mm: 610009 900-1050mm: 610010 1050-1200mm: 610011</p>	

ARCHITECTURAL IRONMONGERY

UPVC DOOR HARDWARE

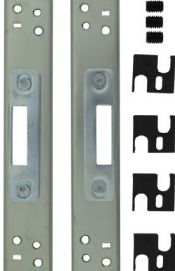

UPVC DOOR
HARDWARE

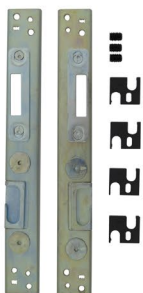
<p>BEST SELLER</p> 	<p>MULTIPOINT REPAIR LOCK - 2 HOOK & 2 ROLLER</p>	<p>This repair lock has the largest range of backsets on the market and has the greatest flexibility when replacing existing multipoint locks</p> <p>Supplied in 3 parts, this repair lock features 500mm of serrations to accept shoot bolts for added security</p> <p>Supplied with specific keeps designed to fit uPVC doors</p> <p>Features a non-handed gearbox with a latch that can be easily reversed</p> <p>Deadbolt throw: 20mm</p> <p>Adjustable roller cams optimise gasket compression for better heat and sound insulation</p> <p>Hooks with hardened steel inserts provide enhanced protection against attack</p>	<p>Product code:</p> <p>004395</p> <p>004396</p> <p>004393</p> <p>004394</p>	<p>Door material:</p> <p>Timber</p> <p>Timber</p> <p>uPVC</p> <p>uPVC</p>	<p>Lock backset (mm)</p> <p>35</p> <p>45</p> <p>35</p> <p>45</p>
	<p>UNIVERSAL HOOK KEEPS</p>	<p>An adjustable hookbolt keep set suitable for most types of multipoint locks</p> <p>Keeps are not profile specific as packers are supplied</p>	<p>Product code: 004390</p>		
	<p>UPVC LATCH & DEADBOLT KEEP</p>	<p>This adjustable latch/deadbolt centre keep is non-handed and is supplied with packers and grub screws to suit all profiles making it one of the most versatile keeps available</p> <p>A unique non-handed latch and deadbolt keep</p> <p>Supplied with packers and grub screws which allow the keep to suit any profile</p> <p>Also suitable for use with latch and hook gearboxes</p>	<p>Product code: 004388</p>		
	<p>HOOK AND ROLLER KEEP</p>	<p>A pair of hook and roller keeps suitable for a huge range of multipoint locks</p> <p>Supplied with packers and grub screws which allow the keep to suit any UPVC profile</p>	<p>Product code: 004389</p>		

ARCHITECTURAL IRONMONGERY

UPVC DOOR HARDWARE



UPVC DOOR
HARDWARE

SHOOT BOLT KIT

Contains reversible top or bottom shoot bolts with keeps suiting the Mitchells range of multipoint locks



Product code: 16mm faceplate: 004391
20mm faceplate: 004392

CONCEALED DOOR RESTRICTOR

A door restrictor, which features an adjustable stop position, creating an opening angle between 90 and 125 degrees

Prevents slamming or swinging of door

Designed to suit aluminium, UPVC and timber doors



Product code: 004397

SPLIT SPINDLE

These split spindles are split into two parts, with a central pin connecting them together, allowing each half to rotate independently



Product code: 004398

WINKHAUS OVERNIGHT LOCK GEARBOX

Lever operated latch and deadbolt

Centres: 92mm

Lock case height: 186mm

Euro profile

Single spindle

Faceplate: 16mm radiused



Product code:
Backset sizes in stock: 35mm: 008464 45mm: 008864

ERA MULTI-POINT GEARBOX

Lever operated latch and deadbolt

Split spindle

Centres: 92mm

Lock case height: 220mm

Universal handing



Product code:
Backset sizes in stock: 35mm: 008248 45mm: 008585

ADJUSTABLE UPVC LEVER HANDLES



Adjustable handle position to suit lock centres between 59 - 96mm

Adaptable backplate to accommodate a wide range of screw hole centres

Concealed external fixing head & outer plate for increased security

Double spring mechanism

Weather resistant finish

Sold as a pair

10 year mechanical guarantee

Product code:	Finish:	Size (mm):
550055	White	290 x 34
550056	Satin Silver	290 x 34
550057	Polished Silver	290 x 34
550058	Gold	290 x 34

ARCHITECTURAL IRONMONGERY

WINDOW HARDWARE



WINDOW HARDWARE

	WINDOW FRICTION HINGES	<p>A range of non-handed friction stays with metal ends Conveniently packaged in pairs with timber fixing screws 4mm packers provided so 13 and 17mm stack heights can be achieved</p> <p>Each stay can swing either way, so they are non-handed</p>	Product code:	Window material	Size (inches)
			004410	Timber	8
			004405	Timber	10
			004406	Timber	12
			004407	Timber	16
			004408	Timber	20
			004409	Timber	24
			004404	uPVC	8
			004399	uPVC	10
			004400	uPVC	12
			004401	uPVC	16
			004402	uPVC	20
			004403	uPVC	24

LOCKABLE CASEMENT FASTENER		
	Product Code:	Finish:
	600004	PB
	600005	PC
	600006	SC
	600007	White

INLINE LOCKING WINDOW HANDLE	
	<p>Handle spindle is turned in the espagnolette gearbox to throw locking points Locked and unlocked by key - push button to release</p> <p>Backplate: 62 x 17mm Screw centres: 43mm Supplied with 1 key Non-handed Suitable for UPVC windows Finishes in stock:</p>
Product code: White: 600012 PC: 600013	

	OFFSET LOCKING WINDOW HANDLE	<p>Handle spindle is turned in the espagnolette gearbox to throw locking points Locked and unlocked by key - push button to release</p> <p>Backplate: 67 x 17mm Screw centres: 43mm Spindle size: 40 x 7mm Supplied with 1 key, 2 bolts and 1 cover cap</p> <p>Handles are handed - (Right hand shown in picture) Suitable for UPVC windows</p>	Product Code:	Hand:	Finish:
			600014	L/H	White
			600015	R/H	White
			600016	L/H	PC
			600017	R/H	PC

ARCHITECTURAL IRONMONGERY

WINDOW HARDWARE



WINDOW HARDWARE

We Cut Keys!

ALUMINIUM CASEMENT FASTENER



Size: 100mm

Product codes: 003788

ANTIQUE CASEMENT FASTENER



Size: 115mm

Product code: 003829

VICTORIAN CASEMENT FASTENER



Size: 105mm

Product code: 003654

VICTORIAN CASEMENT FASTENER



Size: 125mm

Product code: 003653

SASH FASTENER



Size: 65mm
Finish: Brass

Product code: 003708

QUADRANT ARM SASH WINDOW FASTENER



Architectural quality
Finish: SC

Product Code: 600010

VICTORIAN HOOK AND MORTICE FASTENER



Size: 100mm
Finishes in stock:

Product codes:
Brass: 003655 PC: 003741

FITCH SASH WINDOW FASTENER



Basic quality
Finishes in stock:

Product codes:
Zinc plated: 003469 Brass: 003470

FITCH SASH WINDOW FASTENER



Architectural quality
Finish: SC

Product Code: 600009

ARCHITECTURAL IRONMONGERY

WINDOW HARDWARE



WINDOW HARDWARE

SASH LIFT



Architectural quality
Finish: SC

Product Code: 600011

SASH LIFT



Basic quality
Size: 50mm
Finishes in stock:

Product codes:
Brass: 003706 PC: 003770

WINDOW/PATIO DOOR LOCK



Colours in stock:

Product Code: Silver: 003453
Brassed: 003455 White: 003471

SASH EYE



Size: 45mm
Finishes in stock:

Product code:
Brass: 003707 PC: 003771

BRIGHTON SASH WINDOW FASTENER



Basic quality
Finishes in stock:

Product Code:
Zinc plated: 003467 Brass: 003468

BRIGHTON SASH WINDOW FASTENER



Architectural quality
Finish: SC

Product Code: 600008

WINDOW STAY LOCK



Finish: Zinc plated

Product code: 003462

LOCKABLE CASEMENT STAY



Product Code:	Size (mm)	Finish:
600000	250	PB
600001	250	PC
600002	250	SC
600003	250	White

ARCHITECTURAL IRONMONGERY

WINDOW HARDWARE



WINDOW HARDWARE

ALUMINIUM CASEMENT STAY

	Product Code:	Size (mm)
	003785	200
	003786	250
	003787	300

WINDOW RESTRICTOR



Size: 90mm

Product code: 003465

VICTORIAN CASEMENT STAY - SPOON STYLE

	Product Code:	Size (mm)	Finish:
	003650	200	Brass
	003651	250	Brass
	003740	250	PC
	003652	300	Brass

BASIC CABLE WINDOW RESTRICTOR



Product code: 003466

ANTIQUE CASEMENT STAY



Size: 250mm

Product Code: 003828

BRASS SLIDING STAY



Size: 250mm

Product code: 003656

LOCKING CABLE WINDOW RESTRICTOR



Suitable for all window types
Limits the distance a window can open
Key holder can unlock the device to remove the cable which will then allow the window to fully open
Perfect for home, public and commercial applications
Cable length: 150mm Easy to install

Product Code: 600008

ARCHITECTURAL IRONMONGERY

KICK PLATES & FINGER PLATES



KICK & FINGER PLATES

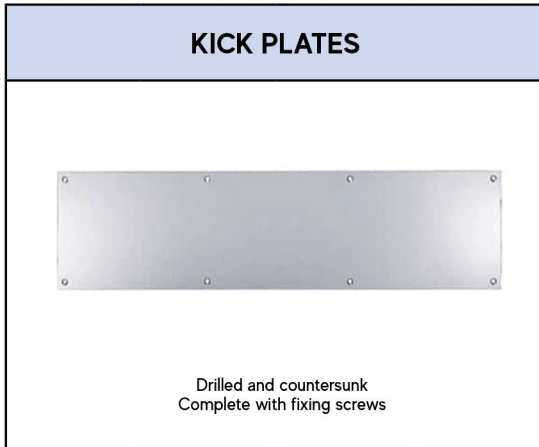

Product Code:	Length (mm)	Height (mm)	Finish:
550261	686	150	SAA
550262	700	150	SAA
550263	762	150	SAA
550071	800	150	SAA
550264	838	150	SAA
550265	864	150	SAA
550266	900	150	SAA
550267	686	200	SAA
550268	700	200	SAA
550269	762	200	SAA
550072	800	200	SAA
550270	838	200	SAA
550271	864	200	SAA
550272	900	200	SAA
550273	686	150	SSS
550274	700	150	SSS
550275	762	150	SSS
550073	800	150	SSS
550276	838	150	SSS
550277	864	150	SSS
550278	900	150	SSS
550279	686	200	SSS
550280	700	200	SSS
550281	762	200	SSS
550074	800	200	SSS
550282	838	200	SSS
550283	864	200	SSS
550284	900	200	SSS

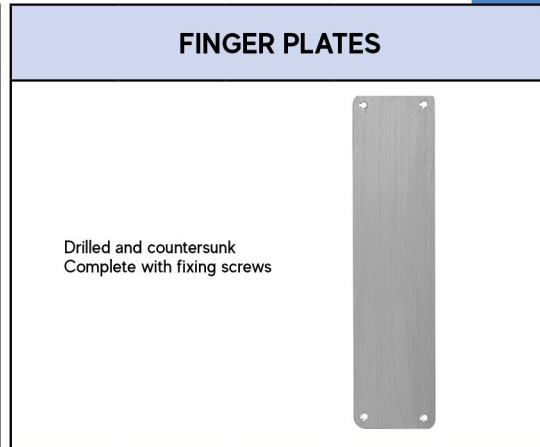

Product Code:	Height (mm)	Width (mm)	Finish:	Corners
550285	200	76	SAA	S
550286	250	76	SAA	S
550059	300	76	SAA	S
550061	350	76	SAA	S
550063	450	76	SAA	S
550287	200	76	SAA	R
550288	250	76	SAA	R
550060	300	76	SAA	R
550062	350	76	SAA	R
550064	450	76	SAA	R
550289	200	76	SSS	S
550290	250	76	SSS	S
550065	300	76	SSS	S
550067	350	76	SSS	S
550069	450	76	SSS	S
550291	200	76	SSS	R
550292	250	76	SSS	R
550066	300	76	SSS	R
550068	350	76	SSS	R
550070	450	76	SSS	R

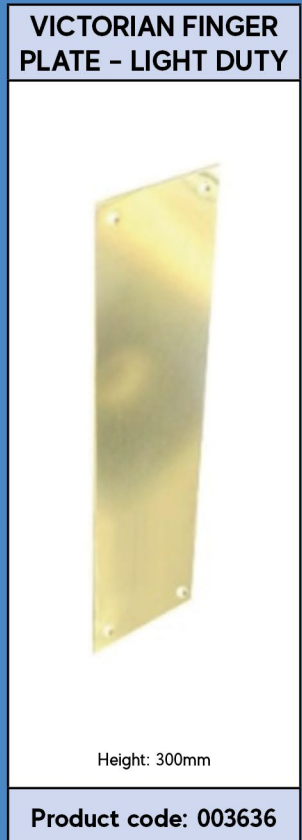

ARCHITECTURAL IRONMONGERY

INTUMESCENT PRODUCTS



INSTUMESCENT
PRODUCTS

INTUMESCENT FIRE STRIP

Graphite based fire seal housed within PVC carrier
 Tested for 30 minutes with 10 & 15mm to BS 476 part 22 & 311
 Tested for 60 minutes with 20mm to BS 476 part 22 & 311
 Smoke seals tested to EN1634-3
 Tested to 100,000 open/close cycles

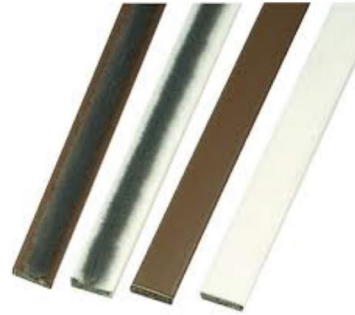

Product code:	Type:	Colour:	Profile Size: (mm)	Fire Rating:
590005	Fire only	White	10 x 4	30 mins
590000	Fire only	Brown	10 x 4	30 mins
590007	Fire only	White	15 x 4	30 mins
590002	Fire only	Brown	15 x 4	30 mins
590006	Fire & smoke	White	10 x 4	30 mins
590001	Fire & smoke	Brown	10 x 4	30 mins
590008	Fire & smoke	White	15 x 4	30 mins
590003	Fire & smoke	Brown	15 x 4	30 mins
590009	Fire & smoke	White	20 x 4	60 mins
590004	Fire & smoke	Brown	20 x 4	60 mins

INTUMESCENT PROTECTION FOR HARDWARE

Suitable for FD30 and FD60 applications
 Flexible 0.8mm thickness
 Self adhesive backed to assist fitting
 Will bend without cracking
 Unaffected by moisture, humidity & atmospheric pollution
 BS 476 part 22 : 1987 - 30 and 60 minute rating
 BS EN 1634-1 : 2008 - 30 and 60 minute rating

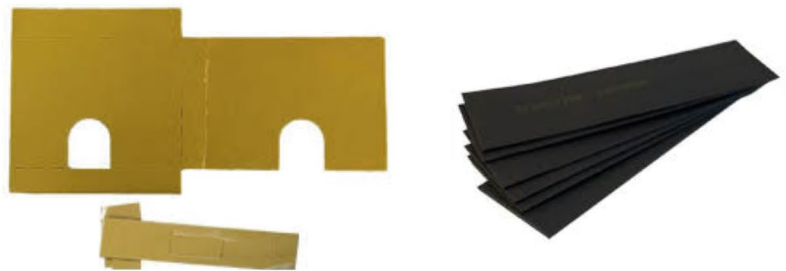

Product code	Application
590010	Hinge pads: 102 x 31mm - pack of 6
590011	Kit for flush bolt - max length 200mm
590012	Jacket & plate kit for DIN sized lock
590013	Jacket & plate kit for UK sized deadlock
590014	Jacket & plate kit for UK sized sashlock
590020	Jacket & plate kit for tubular latch
590015	Sheeting 500 x 500mm for general applications

ARCHITECTURAL IRONMONGERY

INTUMESCENT PRODUCTS



INTUMESCENT
PRODUCTS

	<p>INTUMESCENT LETTERBOX</p>	<p>Rated to FD30/FD30s Finish: SAA Tested to BS 476 part 22 & 311 Tested to EN 1634-3 30mins & BS EN13724 clause 665 Acoustic rating 32dB Adjustable to suit door thicknesses of 40mm to 80mm</p>	<p>Product code:</p>	<p>Aperture (mm)</p>	<p>Overall size (mm)</p>
			<p>590017</p>	<p>221 x 37.5</p>	<p>272 x 70</p>
			<p>590021</p>	<p>254.5 x 37.5</p>	<p>306 x 70</p>



INTUMESCENT THRESHOLD

FD60 Fire & smoke threshold

Finish: SAA

Suitable for inward & outward opening doors

Easy access for light wheeled traffic

Fitted with 60 min fire/smoke seal
NHBC approved
Tested to BS476 part 22 & 311

Seal is replaceable if damaged

Seals gaps of 12 – 15mm

Length: 914mm

Product code: 590019

	<p>FIRE RATED DOOR VIEWER</p>	<p>FD60 rated 120 degree viewing angle Suitable door thickness: 35 – 55mm Tested to BS 476 part 22 60 mins and EN 1634-1 30 mins Conforms to DHF TS002 : 2009 Specification Finish: PC</p>	<p>Product code: 590016</p>
---	--------------------------------------	--	--



PADLOCKS AND SECURITY

Mitchells
Ironmongers

PADLOCKS & SECURITY



PADLOCKS &
SECURITY

BUDGET BRASS PADLOCK		
	Product Code:	Padlock body width (mm)
	003493	20
	003494	25
	003495	30
	003496	35
	003497	40
	003498	45
003499	50	

Complete with 3 keys

PREMIUM BRASS PADLOCK - MULTI-PACKS			
	Product code:	Body width (mm)	Pack size
	004369	30	2 padlocks
	004374	40	2 padlocks
	004373	40	4 padlocks

Keyed alike
4 packs: 5 keys
2 packs: 3 keys

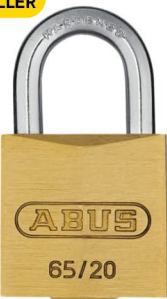
PREMIUM BRASS PADLOCKS				
 BEST SELLER	Product code:	Body width (mm)	Shackle width (mm)	Shackle height (mm)
	004367	20	9	11
	004368	30	15	17
	004370	40	22	22
	004375	50	28	29
	004377	60	33	35

Complete with 2 keys

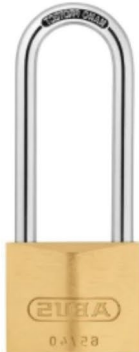
PREMIUM BRASS PADLOCKS - LONG SHACKLE				
	Product code	Body width (mm)	Shackle width (mm)	Shackle height (mm)
	004371	40	22	40
	004372	40	22	63
	004376	50	28	80

Complete with 2 keys

	BUDGET BRASS PADLOCK - LONG SHACKLE	Complete with 3 keys Sizes in stock:	Product code: 40mm: 003500 50mm: 003501
---	--	---	---

	BUDGET BRASS PADLOCK - KEYED ALIKE	Pack of 4 Complete with 3 keys Sizes in stock:	Product code: 30mm: 003491 40mm: 003492
---	---	--	---

PADLOCKS & SECURITY



PADLOCKS &
SECURITY

**We Cut
Keys!**

SECURITY PADLOCK LONG SHACKLE



Size: 65mm
Complete with 3 keys
Finish: Chrome

Product Code: 003485

TRICIRCLE IRON PADLOCK



Finish: Iron
Complete with 3 Keys
Sizes in stock:

**Product Code: 38mm: 003488
50mm: 003489 63mm: 003490**

6 LEVER CLOSED SHACKLE PADLOCK



Complete with 2 Keys
Size: 63mm

Product Code: 003483

LAMINATED PADLOCK



Complete with 2 Keys
Sizes available:

**Product Code:
44mm: 004361 53mm: 004362**

DISKUS PADLOCK STAINLESS STEEL



Complete with 3 keys
Sizes in stock:

**Product Code:
70mm: 003486 90mm: 003487**

WEATHER RESISTANT PADLOCK



Complete with 3 Keys
Finish: Yellow/Black
Sizes in stock:

**Product Code: 40mm: 003502
50mm: 003503 65mm: 003504**

DISKUS PADLOCK MARINE GRADE



Complete with 2 Keys
Sizes in stock:

**Product Code:
60mm: 004358 70mm: 004359**

AQUA SAFE BRASS PADLOCK



Complete with 2 Keys
Shackle Width: 20mm / Shackle Height: 24mm
Shackle Diameter: 8mm / Overall Width: 49mm
Overall Height: 68mm / Overall Depth: 28mm

Product code: 004379

DISCUS COMBINATION PADLOCK STAINLESS STEEL



Size: 70mm

Product code: 003505

PADLOCKS & SECURITY



PADLOCKS &
SECURITY

MONOBLOCK POLISHED CHROME SHUTTER PADLOCK



Complete with 2 Keys
Size: 90mm

Product code: 004385

MONOBLOCK BRASS SHUTTER PADLOCK



Complete with 2 Keys
Sizes in stock:

Product code:
70mm: 004382 90mm: 004383

HARDENED STEEL PADLOCK WITH CLOSED SHACKLE



Complete with 2 Keys
Shackle Width: 24.5mm / Shackle Height: 26.5mm
Overall Width: 55mm

Product code: 004360

HARDENED STEEL PADLOCK



Complete with 2 Keys
Shackle Width: 25mm / Shackle Height: 37mm
Overall Width: 55mm

Product code: 004384

GRANIT™ PLUS PADLOCK CLOSED SHACKLE



Complete with 2 Keys
Shackle Width: 22mm / Shackle Height: 22mm
Shackle Diameter: 14mm / Overall Width: 79mm
Overall Height: 94mm / Overall Depth: 39mm

Product code: 004979

CLOSED SHACKLE PADLOCK



Complete with 3 Keys
Size: 70mm

Product code: 004080

COMBINATION PADLOCK DIE CAST BODY



Sizes in stock:

Product Code: 40mm: 004352
50mm: 004353 65mm: 004354

SOLID BRASS BODY COMBINATION PADLOCK



Sizes in stock:

Product Code
20mm: 004355 30mm: 004356

TITANIUM PADLOCKS



Complete with 2 keys

Product code:	Size (mm)
004363	30
004365	40
004366	50
004381	50 (longer shackle)

PADLOCKS & SECURITY



PADLOCKS &
SECURITY

TITANIUM PADLOCK LONG SHACKLE

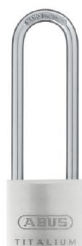

Complete with 2 Keys
Shackle Width: 20mm
Shackle Height: 63mm
Overall Width: 38mm

Product code: 004364

VAN HASP AND PADLOCK



Complete with 3 Keys
Hasp size: 210 x 45mm
Padlock diameter: 73mm
Heavy duty

Product code: 004081

INTEGRAL VAN LOCK



Complete with 2 Keys
Suitable for vans, trucks, garages, sheds or any
outward opening double doors

Product code: 004351

WALL-MOUNTED KEY GARAGE



Internal Dimensions: 95 x 63 x 35mm
External Dimensions: 120 x 80 x 45mm

Product code: 004380

WALL-MOUNTED KEY GARAGE



Internal dimensions: 64 x 90 x 27mm
External dimensions: 85 x 118 x 36mm

Product code: 009154

LOCK LUBRICATING SPRAY

**BEST
SELLER**



Lock Lubricating Spray has been designed to lubricate
and loosen sticking locks and mechanisms
Size: 50ml

Product code: 002633

WIRE HASP AND STAPLE



Finish: Black
Sizes in stock:

Product Code:

75mm: 003526 100mm: 003527

LIGHT SAFETY HASP AND STAPLE



Finish: Black

Product code:	Length (mm)
003520	75
003525	100
003521	115
003522	150

LIGHT SAFETY HASP AND STAPLE



Finish: BZP

Product code:	Length (mm)
003517	90
003518	115
003519	150

PADLOCKS & SECURITY



PADLOCKS &
SECURITY

HEAVY DUTY HASP AND STAPLE



Finish: Black
Size: 185mm

Product code: 003515

LOCKING HASP



Sizes in stock:

Product code: 75mm: 003530
115mm: 003531

HEAVY DUTY HASP AND STAPLE



Finish: Zinc Plated
Size: 185mm

Product code: 003516

HINGED HASP & STAPLE



Hasp length: 195mm
Hasp width: 45mm
Staple bore diameter: 12.5mm

Product code: 004347

SWIVEL LOCKING BAR



Finish: Black
Size: 250mm

Product code: 003451

PREMIUM HASP & STAPLE



Hasp length: 100mm
Hasp width: 35mm
Staple bore diameter: 11mm

Product code: 004347

DISKUS HASP & STAPLE



Finish: Zinc plated
Width: 140mm
Sizes available:

Product Code: 120mm:
004349 190mm: 004350

VERTICAL HASP AND STAPLE



Size: 150mm
Finish: Galvanised

Product code: 010031

BRASS HASP AND STAPLE



Sizes in stock:

Product code: 38mm:
003528 75mm: 003529

HEAVY DUTY HASP AND STAPLE

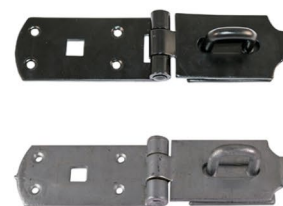

Size: 8"

Product code: Black: 010040
Galvanised: 010041

PADLOCKS & SECURITY



PADLOCKS &
SECURITY

SLIDING GLASS DOOR LOCK



Product code: 003576

DOUBLE LOOP SPIRAL SECURITY CABLE



Finish: Clear
Size: 1500mm

Product code: 003507

SPIRAL CABLE LOCK



Product code: 003506

LOCKING CABLE



Finish: Black
Size: 15mm x 800mm
Complete with 2 Keys

Product code: 003508

VINYL COATED DOUBLE LOOP CABLE



Braided steel cable for increased strength and flexibility

Product code:	Size
004067	8mm x 2.5m
004064	12mm x 2.1m
004065	12mm x 4.5m
004066	15mm x 2.1m

SQUARE LINK SLEEVE CHAIN



Finish: Zinc/Blue Sleeve

Product code:	Size (mm)
003457	6 x 1200
003458	8 x 1000
003459	10 x 1000
003460	10 x 1500
003461	10 x 2000

SLEEVED CHAIN

Sold secure rated special alloy case hardened steel

Flexible polyester black sleeve

Hacksaw and bolt cropper resistant

Weather resistant



Product code:	Size (mm)
004055	10 x 1000mm
004056	10 x 1500mm
004057	10 x 2000mm

GENERAL PURPOSE CHAIN



Sold by the metre

Product Code:	Link thickness (mm)	Opening length (mm)	Finish:
004090	2.5	14	BZP
004091	3.0	16	BZP
004092	4.0	19	BZP
004085	4.0	26	BZP
004086	5.0	21	BZP
004087	5.0	28	BZP
004093	6.0	24	BZP
004088	6.5	36	BZP
004089	8.0	42	BZP
004084	10.0	53	BZP

PADLOCKS & SECURITY



PADLOCKS &
SECURITY

SPIKED CHAIN



Finish: Galvanised
Sold by the metre

Product code: 004094

PLASTIC CHAIN



Colour: Red/White
Sold by the metre
Size: 8.0 x 37mm

Product code: 004095

CASH BOX



Size: 8"

Product code: 004060

20 HOOK KEY CABINET



Combination operated

Product code: 004347

24 HOOK KEY CABINET



Key operated

Product code: 003451

80 HOOK KEY CABINET



Key operated

Product code: 004063

CIGARETTE BIN



Colour: Black
Size: 255 x 320 x 75mm
Galvanised steel

Product code: 004068

CONTEMPORARY POST BOX



Galvanised steel
Size: 368 x 368 x 116mm
Colours in stock:

Product code: Black: 004072
White: 004073

GRAND POST BOX



Galvanised steel
Colour: Black
Size: 326 x 450 x 158mm

Product code: 004074

CLASSIC POST BOX



Galvanised steel
Size: 363 x 370 x 105mm

Product code:	Colour:
004069	Black
004070	Silver
004071	White



WD-40[®]
MULTI-USE PRODUCT
SPRAYS 2 WAYS
• Stops Squeaks
• Removes & Protects
• Loosens Rusted Parts
• Frees Sticky Mechanisms
• Drives Out Moisture
NET WEIGHT
12 OZ./340g

HARDWARE

Mitchells
Ironmongers

HARDWARE

We Cut Keys!



HARDWARE

ONE STRIKE FILLER	ALL-PURPOSE POWDER FILLER	LIBERON WOOD STOP FILLER			
 <p>Product code: 450ml: 002691 1L: 002692</p>	 <p>Interior and exterior use For repairs to plaster, brick, stone and wood Quick setting Size: 1.5Kg</p> <p>Product code: 008976</p>	 <p>Suitable for filling small holes, cracks and gaps in unfinished wood</p>	Product code	Colour:	Size (ml)
			002640	Antique pine	125
			002641	Dark Oak	125
			002642	Light Oak	125
			002643	Victorian Mahogany	125
			002644	Medium Oak	125
			002645	Golden Pine	125
			002646	Neutral	125

HIGH PERFORMANCE WOOD FILLER - 2 PART			
<p>BEST SELLER</p>  <p>Fast drying exterior and interior wood filler Shatterproof finish in approximately 30 minutes Completely weatherproof</p>	Product code:	Finish:	Size (Kg)
	002687	Pine	0.5
	002689	White	0.5
	002688	Pine	1.4
	002690	White	1.4

PREMIUM GRADE JOINERS WOOD FILLER
 <p>Colour: White Waterproof when dry Low odour No mixing required Suitable for exterior and interior Size: 250ml</p> <p>Product code: 002694</p>

PRO-FILL
 <p>Multi-purpose filler For joinery, decorating and building applications Size: 500g Colour: Light grey</p> <p>Product code: 002695</p>

CASCAMITE ADHESIVE
 <p>Sizes in stock:</p> <p>Product code: 125g: 002612 500g: 002613</p>

ECOSOTE
 <p>Eco-friendly wood preserver for exterior timbers Coverage: 4 metre squared per litre Size: 4L Colours in stock:</p> <p>Product code: Light brown: 010008 Dark brown: 010009</p>

HARDWARE



HARDWARE

WOOD STAIN				BLACK BITUMEN PAINT	EVERCRYL ONE COAT
 <p>Touch dry in 30 minutes Overcoat in 4 hours Weatherproof protection Enhances natural qualities of wood</p>	Product code:	Finish:	Size (ml)	 <p>Size: 2.5L Provides a waterproof, weatherproof and corrosion resistant protective coating Suitable for most common building surfaces</p>	 <p>Roof repair compound, effective on all common roofing surfaces Instantly waterproof - no need to wait for the rain to stop Brush applied Colour: Grey Size: 1L</p>
	010001	Natural Oak	250		
	010002	Antique Pine	250		
	010003	Mahogany	250		
	010004	Teak	250		
	010005	Walnut	250		
010006	Rosewood	250	Product code: 002618	Product code: 008976	

HAMMERITE PAINT				
	Product code:	Colour:	Type:	Size (ml)
	002667	Black	Hammered	750
	002669	Black	Smooth	250
	002670	Black	Smooth	750
	002671	White	Smooth	250
	002672	White	Smooth	750

QUICK-DRYING PRIMER
 <p>Colour: White Sizes in stock:</p>
<p>Product code: 500ml: 002681 1L: 002680</p>

HEAT RESISTANT PAINT
 <p>Colour: Black Size: 250ml</p>
<p>Product code: 002676</p>

BLACKBOARD PAINT
 <p>Size: 250ml</p>
<p>Product code: 002679</p>

CLEAR VARNISH
 <p>Sizes in stock:</p>
<p>Product code: 250ml: 002677 500ml: 002678</p>

HARDWARE



HARDWARE

RED OXIDE METAL PRIMER		
	Product code:	Size (ml)
	002683	250
	002684	500
	002682	1000

YACHT VARNISH

Size: 250ml
Product code: 002686

TEAK OIL

Size: 500ml
Product code: 002685

DANISH OIL

Size: 500ml
Product code: 002675

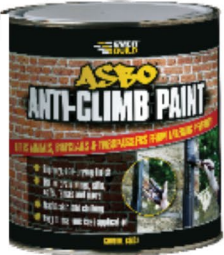
ANTI-CLIMB PAINT

Difficult to remove black marks on offenders' hands Size: 1L
Product code: 002666

BLACK GRATE POLISH

Size: 75ml
Product code: 002656

HAMMERITE SMOOTH AEROSOL PAINT			
	Product code:	Colour:	Size (ml)
	002626	Black	400
	002627	Red	400
	002628	Silver	400
	002629	White	400
	002630	Yellow	400









HIGH HEAT AEROSOL PAINT

Size: 400ml Colour: Black
Product code: 002668

HARDWARE



HARDWARE

<h3>LINE MARKING PAINT</h3>			<h3>COLD GALVANISING SPRAY</h3>		<h3>STAIN BLOCK</h3>	
 <p>Semi-permanent Size: 750ml</p>	Product code:	Colour:	 <p>Size: 500ml</p>	 <p>Quick drying - overcoat in 15 minutes Prevents current stains from showing through subsequent overcoating Size: 400ml</p>	Product code: 002638	Product code: 002665
	004448	Blue				
	004449	Black				
	004450	Green				
	004451	Orange				
	004452	Red				
	004453	White				
004454	Yellow					
<h3>GRAFITTI REMOVER</h3>			<h3>WHITE SPIRIT</h3>		<h3>NITRO-MORS PAINT AND VARNISH REMOVER</h3>	
 <p>Size: 400ml</p>			 <p>Commonly used to clean brushes and equipment Sizes in stock:</p>		 <p>Size: 750ml</p>	
Product code: 002620			Product code: 750ml: 002664 2L: 002663		Product code: 002673	
<h3>SUGAR SOAP</h3>			<h3>METHYLATED SPIRIT</h3>		<h3>PARAFFIN</h3>	
 <p>Ideal for preparing surfaces prior to painting Use on paintwork, vinyl wall coverings and enamel surfaces Size: 500ml</p>			 <p>Sizes in stock:</p>		 <p>Size: 4L</p>	
Product code: 002700			Product code: 250ml: 002699 5L: 002657		Product code: 002662	

HARDWARE



HARDWARE

BRICK AND PATIO CLEANER



Acid based powerful cleaning action
Only suitable for exterior applications
Size: 5L

Product code: 002619

TARMAC RESTORER



4 hours drying time
Specially formulated to make tired old tarmac
look just like new
Size: 5L

Product code: 002624

CONCRETE HARDENER AND DUST PROOFER



Both hardens and dust proofs old and
new concrete floors
Reacts chemically with the lime content to create
a hard-wearing surface
Protects against efflorescence
Dries clear
Size: 5L

Product code: 010010

PATH AND PATIO SEAL



Solvent free coating used to seal paths and patios from
the effects of sunlight, oil, petrol and fungal growth
Size: 5L

Product code: 002623

MORTAR STAIN REMOVER



Size: 5L

Product code: 002622

GREASE GUN - SIDE LEVER



Accepts 400ml cartridges
Supplied with a rigid 150mm extension

Product code: 002594

GREASE CARTRIDGE



Size: 400ml
EP2

Product code: 002701

GREASE GUN CONNECTING HOSE



Fits guns with a 1/8 BSPT thread
Size: 300mm

Product code: 008714

WD-40



Sizes in stock:

Product code: 100ml: 008647
450ml: 009529 600ml: 002637

HARDWARE



HARDWARE

We Cut Keys!

WD-40 TUB AND SPRAY BOTTLE



Size: 5L

Product code: 002625

MULTI-PURPOSE OIL - FLEXICAN



Sizes in stock:

Product code:
100ml: 002652 200ml: 002650

CUTTING/TAPPING FLUID



Size: 500ml

Product code: 002648

CUTTING COMPOUND

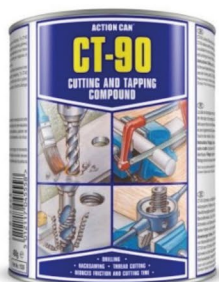

Size: 480g

Product code: 002649

MULTI-PURPOSE OIL - WITH PTFE



Size: 250ml

Product code: 002651

HEAVY DUTY CLEANER DEGREASER



Size: 500ml

Product code: 002653

ANTI-SEIZE COPPER GREASE



Size: 300ml

Product code: 002654

WHITE LITHIUM GREASE



Size: 400ml

Product code: 002631

SILICONE SPRAY



Size: 400ml

Product code: 002621

HARDWARE



HARDWARE

PLUSGAS - AEROSOL



Size: 200ml

Product code: 002632

PARCEL TAPE



Size: 48mm x 50m

Product code: 002723

PRO BLUE MASKING TAPE



Prevents seepage when using highly solvented or thinner coatings such as wood stains or metal paints
Size: 25mm x 33m

Product code: 002706

MASKING TAPE

	Product code:	Width (mm)	Length (m)
	002717	50	50
	002716	38	50
	002715	25	50
	002714	19	50

FROG TAPE



Multi-surface masking tape
For use on cured painted walls, wooden trim, glass and metal
Chemical bonding with emulsion paint results in sharpest line possible
Roll length: 41.1m
Sizes in stock:

Product code:
24mm: 009346 36mm: 009398

GAFFA TAPE

BEST SELLER



Premium quality general purpose gaffa tape
Size: 50mm x 45m

Product code: 004446

MEGA ALL-PURPOSE TAPE



High quality cloth with aggressive natural rubber adhesive
Size: 50mm x 50m
Colours in stock:

Product code:
Silver: 002705 Black: 002704

ANTI-SLIP TAPE



Durable silicone grit surface
Can be applied to most interior and exterior surfaces
Size: 50mm x 10m

Product code: 002703

HARDWARE



HARDWARE

GORILLA TAPE			
	Product code:	Width (mm)	Length (m)
	002720	48	32
	002719	48	11
	002721	25	9

ALUMINIUM TAPE



Ideal for use between foil faced insulation panels, duct sealing on all types of air conditioning and ventilation and protecting wires and pipes from heat
Size: 50mm x 45m

Product code: 002702

JOINTING TAPE



Size: 48mm x 90m

Product code: 005001

WATERPROOF TAPE



Provides waterproof adhesion under wet and dry conditions
Can stretch up to 700% of its original length
Size: 50mm x 15m

Product code: 002722

HAZARD TAPE



Self-adhesive
Size: 50mm x 33m
Colours in stock:

Product code: Red/white: 002713
Black/yellow: 002712

BARRIER TAPE



Size: 70mm x 500m
Colours in stock:

Product code: Red/white: 002711
Black/yellow: 002710

DOUBLE SIDED TAPE



Size: 50mm x 5m

Product code: 002708

HARDWARE



HARDWARE

<p>PTFE TAPE</p>	<p>INSULATION TAPE</p>	<p>CARPET PROTECTOR</p>
 <p>Provides watertight seal on threaded joints Size: 12mm x 12m</p>	 <p>Provides insulation to most electrical wires Manufactured to BS EN 60454 type 2 and IEC 454-2 Size: 19mm x 33m Colour: Black</p>	 <p>Self-adhesive carpet protector Totally waterproof, fire retardant and sticks to most types of surfaces Size: 600mm x 25m</p>
<p>Product code: 002718</p>	<p>Product code: 005000</p>	<p>Product code: 002946</p>

<p>HARD SURFACE PROTECTOR</p>	<p>TPS - MEDIUM DUTY</p>	<p>COTTON TWILL DUST SHEET</p>	<p>FLAME RETARDANT FLOOR PROTECTION</p>
 <p>Self-adhesive Totally waterproof Size: 600mm x 25m</p>	 <p>Temporary protective sheeting Clear cored Size: 4 x 50m</p>	 <p>Size: 3.6 x 2.7m</p>	<p>BEST SELLER</p>  <p>Light duty T-board Flame retardant Cuts with stanley knife Can be bent around corner or pillars, profiling the surface Sheet size: 1.2 x 2.5m Thickness: 2mm</p>
<p>Product code: 002947</p>	<p>Product code: 004312</p>	<p>Product code: 002537</p>	<p>Product code 004306</p>

*Don't forget your
Calfra Tape on
page 77*

<p>DAMP-PROOF COURSE (DPC)</p>	<p>DAMP-PROOF MEMBRANE (DPM)</p>	<p>DPM TAPE</p>	<p>DPM BUTYL TAPE</p>
 <p>30m roll</p>	 <p>1200g (300mu) Size: 4 x 25m BBA standard</p>	 <p>Single sided Size: 75mm x 33m</p>	 <p>Double sided Size: 50mm x 33m</p>
<p>Product code: 100mm: 009666 225mm: 009662 450mm: 009936 600mm: 009941</p>	<p>Product code: 009464</p>	<p>Product code: 009629</p>	<p>Product code: 009630</p>

HARDWARE



HARDWARE

COTTON FIBRE STAIR DUST SHEET

Size: 7.2 x 0.9m

Product code: 002525

RUBBLE SACK - 10 PACK

Woven polypropylene sacks
Size: 900 x 600mm

Product code: 002523

MICRO GORILLA TUB

Sold individually
Size: 0.37L
Colours in stock:

Product code:
Black: 009522 Yellow: 009523

GORILLA TUBS

	Product code:	Size (Litres)	Colour:
	004308	14	Yellow
	004309	26	Yellow
	004310	38	Yellow
	010011	38	Black
	004311	75	Yellow

BLUE POLY ROPE

	Product code:	Size:
	002842	6mm x 30m
	002843	8mm x 30m
	002841	10mm x 30m
	002839	6mm x 220m
	002840	8mm x 220m
	002836	10mm x 220m
	002837	12mm x 220m
	002838	16mm x 220m

PLASTERER'S BATH

Size: 120 x 60 x 30cm

Product code: 002885

TARPAULIN

	Product code:	Size(m)
	002503	3 x 3.6
	002548	3.6 x 6.1
	002519	6.1 x 9

BLACK BUILDER'S BUCKET

BEST SELLER

Size: 14L

Product code: 003043

HARDWARE



HARDWARE

BUNGEE CORD



2 pack
Sizes in stock:

Product code: 24 inch: 002856
36 inch: 002857 48 inch: 002858

**CAM BUCKLE
TIE DOWN STRAP - 4 PACK**



Size: 2m x 25mm
Conforms to BS EN 12195 - 2:2000

Product code: 002479

CARGO LASH SET - 4 PACK



Resistant to cutting and abrasions
Size: 4m x 25mm
Conforms to BS EN 12195 - 2:2000

Product code: 002512

RATCHET STRAP CLAW HOOKS



50mm width
Overall length: 20 meters
Minimum breaking force: 5000 daN
Complies to BS EN 12195-2:2001

Product code: 002844

WEB SLING - 2T



Product code:	Size (metres)
002845	2
002846	3
002847	4
002848	5
002849	6

NYLON CORD



Product code:	Diameter (mm)	Length (m)
009256	1.50 (2H)	100
009465	2.00 (4H)	100
009189	2.75 (8H)	100

CLOTHES LINE



Sizes in stock:

Product code:
10m: 002851 25m: 002852

HARDWARE



HARDWARE

We Cut Keys!

WAXED COTTON SASH CORD



Length: 10m
Diameter: approx 5.5mm (No 2)

Product code: 002850

BROWN JUTE SASH CORD



Length: 12.5m
Diameter: 6mm (No 4)

Product code: 009687

RED SPOT COTTON SASH CORD



Length: 12.5m
Diameter: 5.5mm (No 7)

Product code: 009784

PENDANT MARKER



Length: 26m
Ideal hazard warning on construction sites

Product code: 008474

HOZELOCK STARTER HOSE



Diameter: 12.5mm
10 year guarantee
Sizes in stock:

**Product code: 50m: 003977
30m: 003976 15m: 003975**

HOZELOCK HOSE REEL



Hose length: 25m

Product code: 010013

HOSE REPAIR CONNECTOR



Connects two lengths of hose
Fits 1/2" hose

Product code: 002496

WATER STOP HOSE QUICK CONNECTOR



Halts waterflow when watering equipment is disconnected

Product code: 002514

TAP CONNECTOR



Converts garden tap to universal quick connector outlet
Suitable for 1/2" & 3/4" BSP threaded taps

Product code: 002540

HARDWARE



HARDWARE

SPRAY GUN SET - 5 PCE



Contents: 1/2" hose connector with water-stop to quick connector socket
1/2" hose connector to quick connector socket
1/2" to 3/4" tap reducer
3/4" tap to male quick connector

Product code: 002544

BRASS FEMALE HOSE CONNECTOR



Hose size: 1/2"

Product code: 003980

BRASS MALE HOSE CONNECTOR



Hose size: 1/2"

Product code: 002512

BRASS DOUBLE MALE CONNECTOR



Hose size: 1/2"

Product code: 003982

BRASS TRIPLE MALE CONNECTOR



Hose size: 1/2"

Product code: 003983

BRASS WATER STOP CONNECTOR



Hose size: 1/2"

Product code: 003985

BRASS THREADED FEMALE TAP CONNECTOR



Sizes in stock:

Product code: 1/2": 003986
5/8": 003987 3/4": 003988

BRASS HOSE REPAIRER



Hose size: 1/2"

Product code: 003990

BRASS PUSH ON TAP CONNECTOR



Bore sizes in stock:

Product code: 10-20mm: 003989
20-30mm: 003991

HARDWARE



HARDWARE

ADJUSTABLE SPRAY NOZZLE



Product code: 003984

ADJUSTABLE SPRAY GUN



Product code: 003980

PRESSURE SPRAYER



Size: 5L

Product code: 03972

KNAPSACK PRESSURE SPRAYER



Size: 16L

Product code: 010014

GALVANISED CLEAT HOOK



Size: 100mm

Product code: 001666

TAP WASHERS



Sold as a pair

Product code: 003447

HOT BED HANDLE



Size: 150mm
Finish: Black

Product code: 010044

TURN BUTTONS



Twinpack
Size: 50mm

Product code 003887

GRIPPER CATCH



Finish: Brassed
twinpack

Product code: 003899

HARDWARE



HARDWARE

DOUBLE ROLLER CATCH



Finish: Zinc plated
twinpack

Product code: 003898

SINGLE SCREW-IN PULLEY



Size: 45mm

Product code: 003890

DOUBLE SCREW-IN PULLEY



Size: 45mm

Product code: 003891

SINGLE AXLE PULLEY



Size: 45mm

Product code: 003893

DOUBLE PICTURE HOOK



Size: no3
Twinpack

Product code: 003924

SLOTTED GLASS PLATES



Twinpack
Finish: Brass
Size: 32mm

Product code: 003938

SELF ADHESIVE HOOKS



Pack of 3

Product code: 003932

CUP HOOKS



4-pack

Product code:	Hook size (mm)	Pack size	Material
006542	25	4	White
003925	32	4	White
003926	38	4	White
003927	50	3	White
003928	20	4	Brass
003929	25	4	Brass
003930	32	4	Brass
003931	38	4	Brass

HARDWARE



HARDWARE

CASE CLIPS



Nickel plated
Size: 45mm
Pack of 2

Product code: 003933

CASE CLIPS



Nickel plated
Size: 70mm

Product code: 003934

CASE HANDLE



Size: 175mm

Product code: 009882

CASE CLIPS WITH PADLOCK LOOP



Nickel plated
Size: 95mm

Product code: 003935

SINK PLUG



White
Size: 38mm

Product code: 003941

BATH PLUG



White
Size: 46mm

Product code: 003942

CASE CORNERS



Pack of 4
Nickel plated

Product code: 006598

BATH BALL CHAIN



Size: 450mm

Product code: 003940

SINK BALL CHAIN



Size: 300mm

Product code: 003446

HARDWARE



HARDWARE

MIRROR CORNERS



4 pack
Nickel plated

Product code: 003939

MODESTY BLOCKS



Product code:	Pack size:	Colour:
003936	8	White
003937	8	Brown
003947	100	White
003948	100	Brown

FLUSH MOUNTS



Size: 36 x 36mm
Zinc plated
Pack of 4

Product code: 004102

CHEST CORNER



Size: 50mm
Finish: Brass
Pack size: twin pack

Product code: 003717

METAL SHELF SUPPORTS



Pack of 10

Product code: 004101

KICK-DOWN DOOR STOP



Size: 125mm
Finishes in stock:

Product code:
Brass: 003888 SE: 003889

BLACK DOOR WEDGE



2 pack
Size: 110mm

Product code: 003943

GREY DOOR WEDGE



Size: 140mm

Product code: 003944

MAGNETIC CATCH



3 pack

Product code: 003895

HARDWARE



HARDWARE

We Cut Keys!

HEAVY MAGNETIC CATCH



Size: 60mm

Product code: 003896

TWIN MAGNETIC CATCH



Size: 65mm

Product code: 003897

ADJUSTABLE ROLLER CATCH - NYLON BEVEL



Product code: 003894

POLE HOOK



Finishes in stock:

**Product code: Polished Chrome: 009881
Polished Brass: 009884**

CURTAIN HOOKS



Pack of 25

Product code: 008576

CURTAIN HOLDBACK



Size: 170mm

**Product code: Silver: 008579
Gold: 008578 Black: 008577**

CHILD SAFETY CATCH



Twinpack

Product code: 003900

FURNITURE BOLTS



2 pack
Complete with nuts
M6 x 100mm

Product code: 006532

STORAGE HOOKS - 20 PCE



Ideal for garage, garden and home
PVC coating to prevent scratches

Product code: 010015

HARDWARE



HARDWARE

PULL CORD WEIGHT



Finish: Polished chrome

Product code: 009349

MAGNETIC DOOR HOLDER



Finish: Polished brass

Product code: 007777

LIGHT STRAP HINGE



Size: 200mm
Finish: BZP
Sold as a pair

Product code: 008549

TEE HINGES



Sold as a pair

Product code:	Size (mm)	Finish:	Strength:
001617	150	Black	Light
001618	150	BZP	Light
001619	200	Black	Light
001620	200	BZP	Light
001621	300	Black	Light
001622	300	BZP	Light
001615	450	Black	Medium
001616	450	BZP	Medium
001704	450	Galvanised	Strong
001609	600	Black	Strong
001614	600	BZP	Strong
001610	600	Galvanised	Strong

HOOK AND BAND HINGES



Sold as pairs
Including
all fixings



Product code:	Size (mm)	Finish:	Band type:
005987	350	Black	Straight
001697	350	Black	Cranked
005698	350	Galvanised	Straight
001698	350	Galvanised	Cranked
001628	450	Black	Straight
001634	450	Black	Cranked
001629	450	Galvanised	Straight
001635	450	Galvanised	Cranked
001630	600	Black	Straight
001636	600	Black	Cranked
001631	600	Galvanised	Straight
001637	600	Galvanised	Cranked
001632	750	Black	Straight
001696	750	Black	Cranked
001633	750	Galvanised	Straight
001699	750	Galvanised	Cranked

HARDWARE



HARDWARE

FIELD GATE HINGE SET

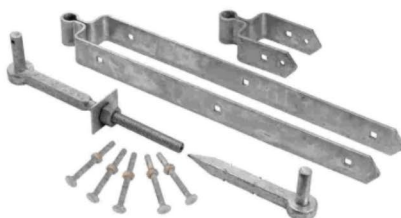

Finish: Galvanised
Size: 600mm

Product code: 001701

ADJUSTABLE HOOK AND BAND



Sold as a pair
Size: 600mm
Finish: Galvanised

Product code: 001700

EXTENDED HOOK ON PLATE



Plate dimensions: 100 x 100mm
Finish: Galvanised
Pin diameter: 19mm

Product code: 003894

HOOK ON PLATE



Finish: Galvanised
Size: 2"

Product code: 010037

STAPLE ON PLATE



Finish: Galvanised
Size: 2"

Product code: 010038

RING ON PLATE



Finish: Galvanised
Size: 2"

Product code: 010039

ADJUSTABLE GATE EYES



Finish: Galvanised

Product code:	Pin Diameter (mm)	Length (mm)
001649	10	100
001650	12	150
001651	16	200
001648	19	250

HOOKS ON PLATES



Sold as pairs

Product code:	Pin diameter (mm)	Band size to suit (inches)	Finish:
001638	12	8 - 16	Black
001639	12	8 - 16	Galvanised
001640	16	18 - 24	Black
001641	16	18 - 24	Galvanised
001642	19	30 - 36	Black
001643	19	30 - 36	Galvanised

HARDWARE



HARDWARE

TWISTED RING GATE LATCH



Size: 6"

Product code: Galvanised: 010036 Black: 010035

BLACK SECURITY STAPLE



Sizes in stock:

Product code: 65 x 45mm: 001718
65 x 55mm: 001719

BLACK GATE STUDS



Sizes in stock:

Product code:
19mm: 007549 40mm: 007548

PLAIN RING GATE LATCH



Size: 150mm
Finishes in stock:

Product code:
Black: 001605 Galvanised: 001606

LONG THROW GATE LOCK

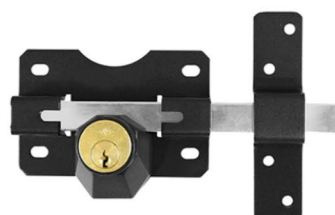

Keyed access from inside and outside the gate.
Supplied with 3 keys

Product code: 50mm: 010098
70mm: 010099

STANDARD MEDIUM SUFFOLK LATCH



Finishes in stock:

Product code:
Black: 001657 Galvanised: 001703

MEDIUM SUFFOLK LATCH - LONG THUMB PIECE



Finish: Black

Product code: 001656

HEAVY SUFFOLK LATCH



Thumb piece: 75mm
Finishes in stock:

Product code:
Black: 001672 Galvanised: 001695

HARDWARE



HARDWARE

TUBULAR STEEL HANDLES



Size: 180mm
Finish: ZP

Product code: 001653

MEDIUM AUTO GATE CATCH



Finishes in stock:

Product code:
Black: 001654 Galvanised: 001702

HEAVY AUTO GATE CATCH



Size: 57mm
Finish: Galvanised

Product code: 001652

HEAVY SELF-LOCKING AUTO GATE CATCH



Finish: Galvanised

Product code: 007847

WIRE CABIN HOOKS

Product code:	Size (mm)	Finish:
001662	75	Black
001663	100	Black
001664	150	Black
001671	150	Galvanised
001665	200	Black
001661	450	Black

ENCLOSED TOWER BOLTS

BEST SELLER	Product code:	Size (mm)	Finish:	Type:
		001705	75	Galvanised
	001688	75	Black	Straight
	001706	100	Galvanised	Straight
	001689	100	Black	Straight
	001691	150	Galvanised	Straight
	001690	150	Black	Straight
	001707	200	Galvanised	Straight
	001692	200	Black	Straight
	001709	150	Galvanised	Necked
	001708	150	Black	Necked

HARDWARE



MEDIUM PADBOLTS			
	Product code:	Size (mm)	Finish:
	001667	150	Black
	001668	150	ZP
	001669	200	Black
	001670	200	ZP

KICK OVER STABLE LATCH

Size: 240mm Finish: Galvanised
Product code: 010045

GARAGE DOOR DROP BOLTS			
	Product code:	Size (mm)	Finish:
	001694	300	Black
	001711	300	Galvanised
	010032	450	Black
	001660	450	Galvanised
	001658	600	Galvanised

SPRING LOADED BOLT

Size: 12mm Finish: ZP
Product code: 001675

THROW OVER LOOP

Length: 350mm Gap width: 76mm Finishes in stock:
Product code: Black: 001646 Galvanised: 001647

SENIOR RELIANCE DOOR HOLDER

Ideal for holding open garage and barn doors over 900mm wide in an open position. Requires minimum lintel width of 60mm. Size: 24"
Product code: 010033





JUNIOR RELIANCE DOOR HOLDER

Ideal for holding open garage and shed doors below 900mm wide. Requires minimum lintel width of 60mm. Size: 15"
Product code: 010034







HARDWARE



HARDWARE

We Cut Keys!





<p>MONKEY TAIL BOLT</p>	<p>BOW HANDLE BOLT</p>	<p>GATE SPRING</p>	<p>LIGHT DUTY GATE WHEEL</p>
 <p>Finish: Black</p>	 <p>Finish: Black</p>	 <p>Size: 200mm Finishes in stock:</p>	 <p>Size: 270mm Finish: Zinc plated</p>
<p>Product code: 300mm: 010047 450mm: 010048</p>	<p>Product code: 300mm: 010049 450mm: 010050</p>	<p>Product code: Black: 001677 ZP: 001678</p>	<p>Product code: 010043</p>



<p>INSULATION RETAINING CLIPS</p>	<p>RESTRAINT STRAPS</p>				<p>HEAVY DUTY GATE WHEEL</p>														
 <p>Size: 80mm</p>					 <p>Size: 370mm Finish: Black</p>														
<p>Product code: 008749</p>	<p>Product code:</p>	<p>Type:</p>	<p>Vertical length (mm)</p>	<p>Horizontal length (mm)</p>	<p>Total length (mm)</p>														
	004107	Twisted	N/A	N/A	1000mm														
	004117	Flat	N/A	N/A	1000mm														
	004108	Bent	1100	100	N/A														
	004114	Bent	700	100	N/A														
	004113	Bent	500	100	N/A														
	004110	Bent	200	100	N/A														
<p>WALL TIES</p>  <p>Size: 225 x 3mm</p> <p>Product code: 008569</p>	<p>GALVANISED ANGLE BRACKETS</p>  <table border="1" data-bbox="571 1935 1018 2089"> <tr> <th>Product code:</th> <th>Dimensions (mm)</th> </tr> <tr> <td>004112</td> <td>50 x 50</td> </tr> <tr> <td>004116</td> <td>90 x 90</td> </tr> <tr> <td>004109</td> <td>150 x 150</td> </tr> </table>				Product code:	Dimensions (mm)	004112	50 x 50	004116	90 x 90	004109	150 x 150	<p>GALVANISED NAIL PLATE</p>  <table border="1" data-bbox="1050 1935 1497 2089"> <tr> <th>Product code:</th> <th>Dimensions (mm)</th> </tr> <tr> <td>004111</td> <td>42 x 178</td> </tr> <tr> <td>004115</td> <td>85 x 178</td> </tr> </table>	Product code:	Dimensions (mm)	004111	42 x 178	004115	85 x 178
Product code:	Dimensions (mm)																		
004112	50 x 50																		
004116	90 x 90																		
004109	150 x 150																		
Product code:	Dimensions (mm)																		
004111	42 x 178																		
004115	85 x 178																		



HARDWARE



HARDWARE

FLAT CONNECTOR PLATE	HOOK BOLT	LYNCH PIN	EYE BOLT												
 <p>Sizes in stock:</p>	 <p>Finish: Zinc plated Sizes in stock:</p>	 <p>Size: 6 x 45mm Finish: Yellow passivated</p>	 <p>Zinc plated</p> <table border="1"> <thead> <tr> <th>Product code:</th> <th>Thread size (mm)</th> <th>Length (mm)</th> </tr> </thead> <tbody> <tr> <td>000902</td> <td>6</td> <td>50</td> </tr> <tr> <td>000903</td> <td>8</td> <td>60</td> </tr> <tr> <td>000901</td> <td>10</td> <td>73</td> </tr> </tbody> </table>	Product code:	Thread size (mm)	Length (mm)	000902	6	50	000903	8	60	000901	10	73
Product code:	Thread size (mm)	Length (mm)													
000902	6	50													
000903	8	60													
000901	10	73													
<p>Product code: 62 x 100mm: 009831 62 x 180mm: 009138</p>	<p>Product code: M6 x 84mm: 000918 M8 x 97mm: 000919</p>	<p>Product code: 004118</p>													

'R' CLIPS	'S' CLIPS	FIXING BAND														
 <p>Finish: Zinc plated</p> <table border="1"> <thead> <tr> <th>Product code:</th> <th>Dimensions (mm)</th> </tr> </thead> <tbody> <tr> <td>004119</td> <td>2 x 57</td> </tr> <tr> <td>004120</td> <td>3 x 70</td> </tr> <tr> <td>004121</td> <td>4 x 75</td> </tr> </tbody> </table>	Product code:	Dimensions (mm)	004119	2 x 57	004120	3 x 70	004121	4 x 75	 <p>Finish: Zinc plated</p> <table border="1"> <thead> <tr> <th>Product code:</th> <th>Dimensions (mm)</th> </tr> </thead> <tbody> <tr> <td>004129</td> <td>3 x 25</td> </tr> <tr> <td>004130</td> <td>4.8 x 50</td> </tr> </tbody> </table>	Product code:	Dimensions (mm)	004129	3 x 25	004130	4.8 x 50	 <p>Galvanised Size: 10m x 20mm</p> <p>Product code: 004123</p>
Product code:	Dimensions (mm)															
004119	2 x 57															
004120	3 x 70															
004121	4 x 75															
Product code:	Dimensions (mm)															
004129	3 x 25															
004130	4.8 x 50															

D' SHACKLES	CARBINE HOOKS																								
 <p>Finish: Zinc plated</p> <table border="1"> <thead> <tr> <th>Product code:</th> <th>Shackle thickness (mm)</th> </tr> </thead> <tbody> <tr> <td>004161</td> <td>6</td> </tr> <tr> <td>004128</td> <td>8</td> </tr> <tr> <td>004124</td> <td>10</td> </tr> <tr> <td>004125</td> <td>12</td> </tr> <tr> <td>004126</td> <td>16</td> </tr> <tr> <td>004127</td> <td>20</td> </tr> </tbody> </table>	Product code:	Shackle thickness (mm)	004161	6	004128	8	004124	10	004125	12	004126	16	004127	20	 <p>Finish: Zinc plated</p> <table border="1"> <thead> <tr> <th>Product code:</th> <th>Shackle thickness (mm)</th> </tr> </thead> <tbody> <tr> <td>004133</td> <td>5</td> </tr> <tr> <td>004134</td> <td>8</td> </tr> <tr> <td>004131</td> <td>10</td> </tr> <tr> <td>004132</td> <td>12</td> </tr> </tbody> </table>	Product code:	Shackle thickness (mm)	004133	5	004134	8	004131	10	004132	12
Product code:	Shackle thickness (mm)																								
004161	6																								
004128	8																								
004124	10																								
004125	12																								
004126	16																								
004127	20																								
Product code:	Shackle thickness (mm)																								
004133	5																								
004134	8																								
004131	10																								
004132	12																								

HARDWARE



HARDWARE

TABLE STRETCHER PLATE



Size: 38mm
Finish: Zinc plated

Product code: 004135

ANTILUCE FASTENER



Finish: Zinc plated

Product code : M8 x 20mm: 004122
M12 x 75mm: 004141

MENDING PLATES



Size: 100mm
Finish: Zinc plated

Product code: 004142

CORNER BRACE



Finish: Zinc plated

Product code:	Size (mm)
004138	25
004139	50
004140	75
004136	100
004137	150

LONDON SHELF BRACKETS



Colour: White

Product code:	Size (inches)
006847	5 x 4
006917	6 x 5
006874	8 x 6
006936	10 x 8
006985	12 x 10

GALVANISED FLUTED ANGLE BRACKET



Sizes in stock:

Product code:
6" x 5": 010016 10" x 8": 010017

SCREW HOOK



Finish: Zinc plated

Product code:	Size (mm)
004143	75
004144	100

SCREW EYE



Finish: Zinc plated

Product code:	Dimensions (mm)
004145	45 x 10
004146	65 x 14

WIRE ROPE - 50M REEL



Material: 7 strands of 7 core steel rope

Product code:	Wire diameter (mm)
004148	2
004149	3
000886	4
004157	5
004150	6

HARDWARE





HARDWARE

RATCHET STRAINER
 <p>Finish: Galvanised Size: 10mm</p>
<p>Product code: 004147</p>

SPRING HOOK TO SWIVEL
 <p>Finish: Zinc plated Size: 100mm</p>
<p>Product code: 004162</p>

FORGED STRAINING SCREWS - EYE TO EYE
 <p>Finish: Zinc plated Size: 8mm</p>
<p>Product code: 004163</p>

FORGED STRAINING SCREWS - HOOK TO EYE		
 <p>Finish: Zinc plated</p>	<p>Product code: 000880</p>	<p>Size (mm): 5 x 110</p>
	<p>Product code: 000881</p>	<p>Size (mm): 6 x 110</p>
	<p>Product code: 000882</p>	<p>Size (mm): 8 x 110</p>
	<p>Product code: 000878</p>	<p>Size (mm): 10 x 125</p>
	<p>Product code: 000879</p>	<p>Size (mm): 12 x 125</p>

WIRE ROPE THIMBLE								
 <p>Finish: Zinc plated</p>								
<table border="1"> <thead> <tr> <th>Product code:</th> <th>Size (mm)</th> </tr> </thead> <tbody> <tr> <td>000887</td> <td>4</td> </tr> <tr> <td>000888</td> <td>5</td> </tr> <tr> <td>004151</td> <td>6</td> </tr> </tbody> </table>	Product code:	Size (mm)	000887	4	000888	5	004151	6
Product code:	Size (mm)							
000887	4							
000888	5							
004151	6							

'U' BOLTS						
 <p>Finish: Zinc plated</p>						
<table border="1"> <thead> <tr> <th>Product code:</th> <th>Dimensions (mm)</th> </tr> </thead> <tbody> <tr> <td>004164</td> <td>8 x 32</td> </tr> <tr> <td>004165</td> <td>10 x 50</td> </tr> </tbody> </table>	Product code:	Dimensions (mm)	004164	8 x 32	004165	10 x 50
Product code:	Dimensions (mm)					
004164	8 x 32					
004165	10 x 50					

QUICK REPAIR LINKS								
 <p>Finish: Zinc plated</p>								
<table border="1"> <thead> <tr> <th>Product code:</th> <th>Size (mm)</th> </tr> </thead> <tbody> <tr> <td>004158</td> <td>3</td> </tr> <tr> <td>004159</td> <td>5</td> </tr> <tr> <td>004160</td> <td>8</td> </tr> </tbody> </table>	Product code:	Size (mm)	004158	3	004159	5	004160	8
Product code:	Size (mm)							
004158	3							
004159	5							
004160	8							

WIRE ROPE GRIP												
 <p>Finish: Zinc plated</p>												
<table border="1"> <thead> <tr> <th>Product code:</th> <th>Size (mm)</th> </tr> </thead> <tbody> <tr> <td>004153</td> <td>3</td> </tr> <tr> <td>004154</td> <td>5</td> </tr> <tr> <td>004155</td> <td>6</td> </tr> <tr> <td>004156</td> <td>8</td> </tr> <tr> <td>004152</td> <td>10</td> </tr> </tbody> </table>	Product code:	Size (mm)	004153	3	004154	5	004155	6	004156	8	004152	10
Product code:	Size (mm)											
004153	3											
004154	5											
004155	6											
004156	8											
004152	10											

TOOL CLIPS										
 <p>Finish: Zinc plated</p>										
<table border="1"> <thead> <tr> <th>Product code:</th> <th>Size (mm)</th> </tr> </thead> <tbody> <tr> <td>010018</td> <td>12</td> </tr> <tr> <td>010019</td> <td>19</td> </tr> <tr> <td>010020</td> <td>25</td> </tr> <tr> <td>010021</td> <td>38</td> </tr> </tbody> </table>	Product code:	Size (mm)	010018	12	010019	19	010020	25	010021	38
Product code:	Size (mm)									
010018	12									
010019	19									
010020	25									
010021	38									

TIMBER CONNECTOR - DOUBLE SIDED
 <p>Size: 50mm Finish: Galvanised</p>
<p>Product code: 006437</p>

HARDWARE



HARDWARE

CASTORS - POLYURETHANE WHEEL





Product code:	Wheel diameter (mm)	Fixing type:	Brake/No brake:	Swivel/Fixed:	Safe working load (Kg)
004280	50	Plate	No brake	Swivel	50
004281	50	Bolt through	No brake	Swivel	50
004282	50	Plate	No brake	Fixed	75
004283	75	Plate	No brake	Swivel	70
004284	75	Plate	Brake	Swivel	70
004285	75	Bolt through	No brake	Swivel	70
004286	75	Bolt through	Brake	Swivel	70
004287	75	Plate	No brake	Fixed	100
004288	100	Plate	No brake	Swivel	125
004289	100	Plate	Brake	Swivel	125
004290	100	Bolt through	No brake	Swivel	125
004291	100	Bolt through	Brake	Swivel	125
004292	100	Plate	No brake	Fixed	125

HARDWARE



HARDWARE

WELDED EYE BOLT		
 <p>Galvanised Thread: 3/8"</p>	Product code:	Size (mm)
	000883	150
	000884	200
	000885	250

JUBILEE CLIP		
 <p>Mild steel Sold individually or as boxed quantities</p>	Product code:	Diameter range (mm)
	000890	9.5 - 12
	000889	13 - 20
	000893	18 - 25
	000894	25 - 35
	000895	35 - 50
	000896	55 - 70
	000897	70 - 90
	000898	90 - 120
	000899	135 - 165
	000900	184 - 216
	000891	235 - 267
000892	286 - 318	

BARBED WIRE	PLASTIC COATED WIRE	GALVANISED WIRE	RAZOR WIRE - CONCERTINA
 <p>Length: 30 metres</p> <p>Product code: 000911</p>	 <p>Colour: Green Size: 2mm x 15m</p> <p>Product code: 000912</p>	 <p>Size: 2mm x 20m</p> <p>Product code: 009846</p>	 <p>Size: 450mm x 10m</p> <p>Product code: 007821</p>

HARDWARE



HARDWARE

We Cut Keys!

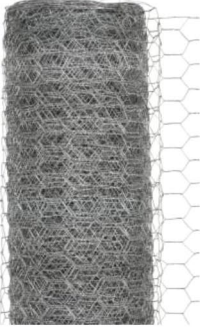
WIRE MESH FENCING			
	Product code:	Roll height (mm)	Mesh hole size (mm)
	000913	600	13
	000915	600	25
	000914	900	13
	000916	900	25

10m rolls

ORANGE BARRIER FENCING - MEDIUM DUTY



Size: 50 x 1m

Product code: 010022

FENCING PINS



Size: 1370mm

Product code: 000917

HEAVY DUTY HAND CABLE PULLER



Ideal for fencing, tree stump removal and other alignment tasks
2000Kg/3m cable

Product code: 010023

WALL STARTER KIT



Stainless steel
Length: 1200mm
Width: 41mm

Product code: 009192

FENCE PANEL CLIPS



Galvanised
Length: 50mm
Depth: 25mm
Widths in stock

Product code:
44mm: 009947 50mm: 009946

TREND WINBAG

BEST SELLER



Inflatable airbag lifter

Product code: 009146

ASSORTED PLASTIC PACKERS - 100 PACK



Stackable
For an array of levelling applications

Product code: 002518

DOOR AND BOARD LIFTER



Allows controlled lifting of plasterboard, doors, and other sheet material

Product code: 002559

HARDWARE



HARDWARE

COPPER SLATE STRAPS - 10PK

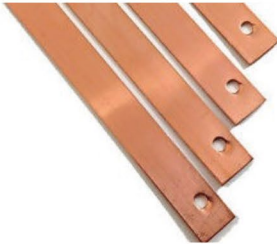

Size: 12 x 150mm

Product code: 001170

GENERAL PURPOSE SANDPAPER ROLL



Size: 115mm x 5m
Suitable for wood, metal, fillers and painted surfaces

Product code:	Grit
004010	40
004011	60
004012	80
004013	120
004014	240

WET AND DRY PAPER SHEETS



Suitable for metal, primer, paint and fillers
Size: 230 x 280mm
Sold individually

Product code:	Grit
004010	40
004011	60
004012	80
004013	120
004014	240

SANDING SPONGE



Size: 100 x 70 x 25mm
Suitable for metal, wood, filler and painted surfaces

Product code:	Grit
004023	40
004024	80
004025	120

EMERY ROLL



Premium aluminium oxide grain
Designed for general maintenance work, rust removal, sanding and polishing
Grits in stock:

Product code: 80G - 003997
120G: 003998 180G: 003999

EMERY CLOTH SHEET



Sold individually
Size: 230 x 280mm
Premium aluminium oxide grain
Designed for general maintenance work, rust removal, sanding and polishing
60 Grit

Product code: 004000

GENERAL PURPOSE HAND PAD



Medium non-woven hand pad
Suitable for stainless steel, metal, plastic, aluminium
Size: 150 x 230mm
Colour: Green

Product code: 004051

CORK SANDING BLOCK



Size: 110 x 60 x 30mm

Product code: 008745

STEEL WOOL



Suitable for wood, metal, non-ferrous and rust

Product code:	Type
004048	Fine
004049	Medium
004050	Coarse



FIXINGS

Mitchells
Ironmongers

SCREW GAUGES

Metric (mm)	Gauge
2.8	4
3.2	5
3.5	6
3.8	7
4.2	8
4.5	9
4.8	10
5.5	12

FIXINGS

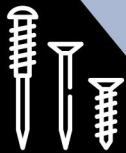

FIXINGS

CLASSIC WOOD SCREWS



Yellow passivated finish for increased corrosion resistance
 25-degree sharp point
 Countersunk head
 Partially threaded after 70mm
 Box quantities of 100 or 200, depending on length – 150mm length and over
 also sold individually

Product code:	Gauge (mm)	Length (mm)
001287	3	12
001288	3	16
001289	3	20
001290	3.5	12
001291	3.5	16
001292	3.5	20
001293	3.5	25
001294	3.5	30
001295	3.5	35
001296	3.5	40
001297	4	16
001298	4	20
001299	4	25
001300	4	30
001301	4	35
001302	4	40
001303	4	45
001304	4	50
001305	4	60
001306	4	70
001307	4.5	25
001308	4.5	30

Product code:	Gauge (mm)	Length (mm)
001309	4.5	35
001310	4.5	40
001311	4.5	50
001312	4.5	60
001313	4.5	70
004623	4.5	80
001314	5	25
001315	5	35
001316	5	40
008564	5	45
001318	5	50
001319	5	60
001320	5	70
001321	5	90
001322	5	100
001323	6	70
001324	6	90
001325	6	100
001326	6	130
001327	6	150
001328	6	180
001329	6	200

STANDARD WOOD SCREWS



A basic woodscrew for the budget conscious tradesman
 Finish: BZP
 Countersunk head
 Twin thread
 Box quantities of 100 or 200, depending on length

Product code:	Gauge (mm)	Length (mm)
000920	3	16
000922	3	25
000923	3.5	19
000924	3.5	25
000925	3.5	32
000926	3.5	38
000927	3.5	44
000928	3.5	51
000929	3.8	19
000930	3.8	25
000931	3.8	32
000932	3.8	38
000934	4.2	16
000935	4.2	19
000936	4.2	25
000937	4.2	32
000938	4.2	38
000939	4.2	44
000940	4.2	51

Product code:	Gauge (mm)	Length (mm)
000941	4.2	57
000942	4.2	64
000943	4.2	76
000944	4.8	25
000945	4.8	32
000946	4.8	38
000948	4.8	51
000949	4.8	57
000950	4.8	64
000951	4.8	76
000952	4.8	89
000953	4.8	102
000954	5.5	25
000956	5.5	51
000957	5.5	64
000958	5.5	76
000959	5.5	89
000960	5.5	102

FIXINGS

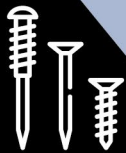

FIXINGS

REISSER CUTTER SCREWS

**BEST
SELLER**



High performance woodscrew
Two patented slots to prevent splitting close to the edge
Ribs and tucks to enable flush fitting
Waxed thread
Countersunk head
Zinc and yellow passivated for increased rust resistance
Sold in boxes

Product code:	Gauge (mm)	Length (mm)	Quantity in box
001258	3.5	16	200
001255	3.5	20	200
001284	3.5	25	200
001256	3.5	30	200
001257	3.5	40	200
001261	3.5	50	200
001285	4	16	200
001259	4	20	200
001260	4	25	200
001253	4	30	200
001254	4	35	200
001262	4	40	200
001263	4	45	200
001264	4	50	200
001265	4	60	200
001266	4	70	200
001267	4.5	30	200
001268	4.5	40	200
001269	4.5	50	200
001270	4.5	60	200
001271	4.5	70	200

Product code:	Gauge (mm)	Length (mm)	Quantity in box
001272	4.5	80	200
001251	5	30	200
001273	5	40	200
001274	5	50	200
001252	5	60	200
001275	5	80	200
001276	5	100	200
001277	6	50	200
001278	6	60	100
001279	6	80	100
001280	6	100	100
001281	6	120	100
001282	6	150	100
001283	6	180	100
001242	4	50	900
001243	4	60	700
001244	4	70	650
001245	4	80	500
001247	5	60	500
001248	5	70	450
001249	5	80	400
001250	5	90	300
001246	5	100	250

CLASSIC SCREWS - STAINLESS STEEL



Exceptional reliability and strength
Stainless steel material for increased durability
Countersunk head
25-degree sharp point
Sold in boxes of 200

Product code:	Gauge (mm)	Length (mm)
001330	4	16
001331	4	25
001332	4	30
001333	4	40
001334	4	50
001317	5	40
001335	5	50
001336	5	70

COLLATED FLOORING SCREWS



For attaching internal floor sheets and planks to timber joints
Compatible with all leading power tool brands
Sold in boxes of 1000
Size: 4.2 x 55mm

Product code: 001286

EXTERIOR TIMBER SCREW - HEX HEAD



8mm hex head
Extra corrosion resistance
Sold individually or in boxes of 50

Product code:	Gauge (mm)	Length (mm)
001482	6.7	150
001482	6.7	200
001483	6.7	250

DECKING SCREWS



Advanced timber decking screws
Torx 20 head
Box of 250

Product code:	Gauge (mm)	Length (mm)
001484	4.5	50
001485	4.5	65
001486	4.5	75

DRY WALL SCREWS - FINE THREAD



Used to secure plasterboard to drywall track and ceiling track
Finish: Black phosphate
Countersunk head
Sold in boxes of 200

Product code:	Gauge (mm)	Length (mm)
001338	3.5	32
001340	3.5	38
001341	3.5	42
001343	3.5	45
001345	3.5	50
001346	3.5	60
001348	4.2	65
001350	4.2	75
001351	4.8	100

COLLATED DRYWALL SCREWS



Coarse thread
Sold in boxes of 1000
Used to secure plasterboard to timber stud work
Compatible with the majority of leading power tool brands

Product code:	Gauge (mm)	Length (mm)
001337	3.5	32
001339	3.5	38
001342	3.5	45
001344	3.5	50
001347	4.2	65
001349	4.2	75

FIXINGS



FIXINGS

We Cut Keys!

SELF-TAPPING SCREWS

These screws tap their own thread when used in conjunction with a pilot hole. Suitable for use in hardwood and metals.

Available with countersunk and pan heads.

Sold individually or in boxes of 250, 500 or 1000, depending on screw size.

Finish: Zinc



Product code	Screw head	Gauge (mm)	Length (mm)
001458	Pan	2.9	16
001459	Pan	2.9	19
001461	Pan	3.5	16
001462	Pan	3.5	19
001463	Pan	4.2	13
001466	Pan	4.2	25
001467	Pan	4.2	32
001468	Pan	4.2	45
001469	Pan	4.8	25
001470	Pan	4.8	50
001471	Pan	5.5	25
001472	Pan	5.5	50
001445	CSK	2.9	9.5
001446	CSK	2.9	13
001447	CSK	2.9	16
001448	CSK	2.9	19
001449	CSK	3.5	13
001450	CSK	3.5	19
001451	CSK	4.2	16
001452	CSK	4.2	32
001453	CSK	4.2	38
001454	CSK	4.8	19
001455	CSK	4.8	25
009993	CSK	4.8	38
001456	CSK	4.8	45
001457	CSK	4.8	50

SECURITY SCREWS

Hex pin drive

Stainless steel

Sold individually or in boxes of 100



Product code	Gauge (mm)	Length (mm)	Head type
001524	3.5	19	CSK
001515	3.5	19	Button
001526	4.2	25	CSK
001528	4.2	32	CSK
001530	4.2	38	CSK
001532	4.2	50	CSK
001517	4.2	25	Button
001543	4.2	32	Button
001522	4.2	38	Button
001519	4.2	50	Button
001534	4.8	25	CSK
001536	4.8	32	CSK
001537	4.8	38	CSK
001539	4.8	50	CSK
001541	4.8	63	CSK
001505	4.8	25	Button
001509	4.8	32	Button
001511	4.8	38	Button
001507	4.8	50	Button
001513	4.8	63	Button

BAYPOLE SCREWS



Designed for window and door fabrication purposes
Wafer flange
Zinc plated
Self-drilling
Phillips head
Sold individually or in boxes of 200

Product code	Gauge (mm)	Length (mm)
001395	4.8	40
001397	4.8	50
001399	4.8	60
001401	4.8	70
001403	4.8	80
001405	4.8	90
001407	4.8	100

WING TIP SCREWS



For timber to light section steel
Phillips CSK head
Zinc plated
Self-drilling
Sold individually or in boxes of 100 or 200, depending on screw size

Product code	Gauge (mm)	Length (mm)
001427	5.5	50
001428	5.5	65
001429	5.5	85
001424	5.5	100
001425	5.5	130
001426	5.5	150

SELF-DRILLING SCREWS



No need for a pilot hole
Sold individually or in boxes of 500 or 1000, depending on screw size

Product code	Gauge (mm)	Length (mm)	Head type
001391	4.8	13	Hex
001392	4.8	16	Hex
001393	4.8	19	Hex
001394	3.9	45	CSK
001409	4.8	25	CSK
001410	4.8	38	CSK
001411	4.8	45	CSK

SELF-DRILLING SCREW - LIGHT SECTION STEEL



With EPDM washer
Silver
8mm hex head
Sold individually or in boxes of 100
Suitable for exterior

Product code	Gauge (mm)	Length (mm)
001419	5.5	25
001420	5.5	32
001421	5.5	38
001422	5.5	50
001423	5.5	70
001418	5.5	100

SELF-DRILLING SCREW - HEAVY SECTION STEEL



With EPDM washer
Silver
8mm hex head
Sold individually or in boxes of 100
Suitable for exterior

Product code	Gauge (mm)	Length (mm)
001413	5.5	32
001414	5.5	38
001415	5.5	55
001416	5.5	65
001417	5.5	80
001418	5.5	100

STITCHING SCREWS

Used for stitching two metal roofing sheets together

Self-drilling

Silver

8mm hex head

Sold individually or in boxes of 100

Suitable for exterior use

Size: 6.3 x 25mm



Product code: 001430

FIXINGS

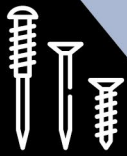

FIXINGS

CONCRETE SCREWS

BEST SELLER



Torx 30 drive
Provides a direct fixing into masonry
6mm pilot hole required
Available individually or in boxes of 100

Product code	Gauge (mm)	Length (mm)
001554	7.5	60
001555	7.5	80
001551	7.5	100
001552	7.5	120
001553	7.5	150
009264	7.5	180

STANDARD NYLON PLUGS



Available individually or boxed sizes which can vary

Product code	Hole size (mm)	Plug length (mm)
009587	6	30
001359	8	40
001356	10	50
001357	12	60
001358	14	75

FISCHER NYLON PLUGS



Rimless
Anti-rotation lock
Sold in boxes of 100

Product code	Hole diameter (mm)	Hole depth (mm)
009928	5	35
009267	6	40
005697	7	40
009741	8	55

PREMIUM DUO POWER PLUG



Narrow rim prevents slipping into hole
Anti-rotation
Used as a wall plug and an effective cavity wall fixing
Available individually or in boxes of 50 or 100, depending on plug size

Product code	Hole diameter (mm)	Plug length (mm)
001363	5	30
001364	6	40
001362	7	50

PLASTIC FIXING PLUGS



Box of 100

Product code	Hole diameter (mm)	Plug length (mm)	Colour
001238	5.5/6.0	30	Red
001239	7.0	35	Brown

SANITARY FIXING KITS



Sold as a pair
Size: M8 x 120mm

Product code: 001240

FIXINGS



FIXINGS

WC FIXING KIT



Designed for fixing WC's
Sold as a pair
Size: M6 x 80mm

Product code: 001241

DOMED SCREW COVER CAPS



Two-piece screw caps
Suitable for screw sizes 6 - 8
Bag sizes may vary depending on manufacturer

Product code:	Colour
001434	Chrome
009880	White
001431	Black

REISSER CUTTER SCREW - TRADE PACK



Contents:

4 x 25mm

4 x 30mm

4 x 40mm

4 x 50mm

5 x 40mm

5 x 50mm

5 x 60mm

5 x 80mm

1 pack of PZ2 bits

Product code: 009864

CLASSIC SCREWS ASSORTED TRAY



Finish: Zinc and yellow
895 pce

Contents:

3.5 x 16mm

3.5 x 25mm

3.5 x 30mm

4.0 x 20mm

4.0 x 25mm

4.0 x 30mm

4.0 x 40mm

4.0 x 50mm

4.0 x 60mm

5.0 x 40mm

5.0 x 50mm

5.0 x 60mm

Product code: 009508

SELF-TAPPING SCREWS ASSORTED TRAY



1305 pce
Finish: Zinc - plated in Trivalent Chromium

Contents:

6 x 1/4 Pan head

6 x 1/2 Pan head

6 x 3/4 Countersunk

8 x 1/2 Pan head

8 x 1/2 Countersunk

8 x 3/4 Pan head

8 x 3/4 Countersunk

8 x 1 Pan head

8 x 1 Countersunk

8 x 1.1/2 Countersunk

10 x 1/2 Pan head

10 x 5/8 Countersunk

Product code: 009526



FIXINGS

FIXINGS

ROOFING BOLTS

Complete with square nuts

Sold individually or in boxes of 100 or 200, depending on bolt size

Finish: Zinc plated



Product code	Diameter (mm)	Length (mm)
001008	6	16
001009	6	20
001010	6	25
001011	6	30
001012	6	40
001013	6	50
001014	6	60
001052	6	100

CUP SQUARE BOLTS



Sold individually or boxed
Boxed quantities are supplied with hex nuts
Finish: Zinc plated

Product code	Diameter (mm)	Length (mm)
001059	6	25
001060	6	40
001061	6	50
001062	6	75
001063	6	100

001064	6	150
001065	8	40
001066	8	50
001067	8	75
001068	8	90
001069	8	100
001070	8	110
001071	8	130
001072	8	150
001073	8	200
001074	10	50
001075	10	75
001076	10	100
001077	10	110
001078	10	130
001079	10	150
001080	10	180
001081	10	200
001082	10	240
001083	12	75
001084	12	100
001085	12	130
001086	12	150
001087	12	180
001088	12	200
001089	12	240
001090	12	300

FIXINGS



FIXINGS

HEXAGON COACH SCREWS

Sold individually
Finish: Zinc plated



Product code	Gauge (mm)	Length (mm)
001378	6	25
001379	6	40
001380	6	50
001382	6	75
001377	6	100
001386	8	40
001387	8	50
001389	8	75
001383	8	100
001384	8	120
001385	8	150
001370	10	40
001371	10	50
001372	10	65
001373	10	75
001366	10	100
001367	10	120
001368	10	150
001369	10	200
001376	12	80
001374	12	100
001375	12	150

HEX SET SCREW

High tensile grade 8.8
Zinc plated
Available individually or boxed



Product code	Diameter (mm)	Length (mm)
001091	6	12
001092	6	30
001093	6	40
001094	6	50
001095	6	75
001096	6	100
001097	8	20
001098	8	25
001099	8	30
001100	8	40
001101	8	50
001102	8	75
001103	8	100
001104	10	25
001105	10	30
001106	10	35
001107	10	40
001108	10	50
001109	10	55
001110	10	65
001111	10	75
001112	10	100
001113	10	150
001114	12	40
001115	12	50
001116	12	65
001117	12	75
001118	12	100
001119	12	150
001120	16	50
001121	16	75
001122	16	100

FIXINGS



FIXINGS

We Cut Keys!

THROUGH BOLTS	Product code	Width (mm)	Hole size (mm)	Anchor length (mm)	Thread length (mm)	Min hole depth (mm)
 <p>Common masonry and concrete fixing Supplied with pre-assembled nut and washer Sold individually Finish: Zinc plated</p>	000969	6	6	45	18	30
	000970	8	8	50	25	35
	000971	8	8	80	25	40
	000972	8	8	100	25	40
	000973	10	10	65	30	40
	000974	10	10	90	40	50
	000975	12	12	100	40	60
	000976	12	12	120	40	60
	000977	12	12	180	40	60
	000978	16	16	150	60	80
009999	20	20	160	65	100	

HEX NUT SLEEVE ANCHORS	Product code	Width (mm)	Anchor length (mm)	Hole size (mm)	Min hole depth (mm)
 <p>General purpose expansion anchor Material: Mild steel Sold individually</p>	000961	8	65	8	40
	000962	10	97	10	45
	000963	12	60	12	55
	000964	12	129	12	55

DROP IN WEDGE ANCHORS	Product code	Thread size (mm)	Hole size (mm)	Anchor length (mm)	Interior thread length (mm)	Min hole depth (mm)
 <p>Provides a permanently fixed threaded socket in concrete Sold individually</p>	000979	6	8	25	10	25
	000980	8	10	30	14	30
	000981	10	12	40	15	40
	000982	12	16	50	20	50

FIXINGS



FIXINGS

EYE BOLT SHIELD ANCHORS	Product code	Thread Diameter (mm)	Hole size (mm)	Eye hole width (mm)	Shield length (mm)	Min hole depth (mm)
 <p>Suitable for anchorage into masonry Sold individually Finish: Zinc yellow</p>	000985	6	12	10	45	50
	000986	8	14	12	50	55
	000984	10	16	14	60	65

HOOK SHIELD ANCHOR	Product code	Thread diameter (mm)	Hole size (mm)	Shield length (mm)	Min hole depth (mm)
 <p>Suitable for anchorage into masonry Sold individually Finish: Zinc yellow</p>	000988	6	12	45	50
	000989	8	14	50	55
	000987	10	16	60	65

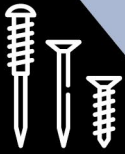

LOOSE BOLT SHIELD ANCHORS	Product code	Thread size (mm)	Hole size (mm)	Shield length (mm)	Bolt length (mm)	Min hole depth (mm)
 <p>Expansion anchor suitable for masonry Sold individually Finish: Zinc plated</p>	000996	6	12	45	55	50
	000997	6	12	45	85	50
	000998	8	14	50	65	55
	000999	8	14	50	95	55
	000990	10	16	60	75	65
	000991	10	16	60	90	65
	000992	10	16	60	140	65
	000993	12	20	75	90	85
	000994	12	20	75	120	85
	000995	16	25	115	150	125

FIXINGS



FIXINGS

PROJECTING BOLT SHIELD ANCHORS	Product code	Thread diameter (mm)	Hole size (mm)	Shield length (mm)	Bolt length (mm)	Min hole depth (mm)
 <p>Expansion anchor suitable for masonry Sold individually Finish: Zinc plated</p>	001005	6	12	45	115	50
	001006	8	14	50	90	55
	001007	8	14	50	125	55
	001000	10	16	60	90	65
	001001	10	16	60	135	65
	001002	12	20	75	125	85
	001003	12	20	75	170	85
	001004	16	25	115	170	125

ANKER BOLTS	Product code	Drill Diameter (mm)	Length (mm)	Head type
   <p>Self-tapping fixing Suitable for use in materials such as concrete, hollow concrete, bricks, dense blocks, and most natural stone Sold individually</p>	001556	6	90	Hook
	001557	8	90	Hook
	001558	6	90	Eye
	001559	8	90	Eye
	001560	5	50	Flange hex head
	001561	5	75	Flange hex head
	001562	6	50	Flange hex head
	001563	6	75	Flange hex head
	001564	6	100	Flange hex head
	001565	8	60	Flange hex head
	001566	8	75	Flange hex head
	001567	8	100	Flange hex head
	001568	8	130	Flange hex head
	001569	8	150	Flange hex head
	001570	10	75	Flange hex head
	001571	10	100	Flange hex head
	001573	10	130	Flange hex head
001572	10	150	Flange hex head	
004872	10	200	Flange hex head	

FIXINGS



FIXINGS

HEX COVER CAPS

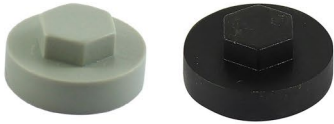

To suit 8mm hex heads
Sold individually

Product code:	Colour:
001432	Goosewing grey
004565	Black

BOLT PROTECTION CAPS

To protect nuts & bolts with a hex head

Sold individually



Product code:	Bolt diameter to suit (mm)	Colour:
001435	10	Black
001437	12	Black
001436	10	White
001438	12	White

COLLATED NAILS - SECOND FIX



18G - Box of 5000
16G - Box of 2000

Product code:	Gauge	Length (mm)	Type:	Material:
001211	16	32	Angled	Galvanised
001212	16	38	Angled	Galvanised
001213	16	45	Angled	Galvanised
001214	16	50	Angled	Galvanised
001215	16	64	Angled	Galvanised
001218	16	19	Straight	Galvanised
001219	16	25	Straight	Galvanised
001220	16	32	Straight	Galvanised
001221	16	38	Straight	Galvanised
001222	16	45	Straight	Galvanised
001223	16	50	Straight	Galvanised
001224	16	64	Straight	Galvanised
001225	18	16	Straight	Galvanised
001226	18	19	Straight	Galvanised
001227	18	25	Straight	Galvanised
001228	18	32	Straight	Galvanised
001210	18	38	Straight	Galvanised
001229	18	45	Straight	Galvanised
001230	18	50	Straight	Galvanised
001216	16	38	Angled	SS
001217	16	50	Angled	SS
001231	16	38	Straight	SS
001232	16	50	Straight	SS
001233	18	19	Straight	SS
001234	18	25	Straight	SS
001235	18	32	Straight	SS
001236	18	38	Straight	SS
001237	18	50	Straight	SS

THREADED BAR



Length: 1 metre

Product code:	Thread (mm)	Material :
001154	3	Galvanised
001155	4	Galvanised
001156	5	Galvanised
001157	6	Galvanised
001158	8	Galvanised
001150	10	Galvanised
001151	12	Galvanised
001152	16	Galvanised
001153	20	Galvanised
006548	24	Galvanised
001147	6	SS
001148	8	SS
001149	10	SS

INJECTION RESIN

BEST SELLER



Vinyl ester hybrid mortar
Temperature resistance from -40 to +120 degrees Celsius - solid load level even when subjected to high temperatures
Complete with mixing nozzle

Product code:
300ml: 001134 380ml: 001135

COLLATED NAILS - FIRST FIX

Contents: 2200 nails
+ 2 fuel cells

Finish: Galvanised



Product code:	Gauge (mm)	Length (mm)
001126	2.8	50
001127	2.8	63
001129	2.8	75
001128	3.1	63
001130	3.1	75
001125	3.1	90



FIXINGS

FIXINGS



GALVANISED ROUND WIRE NAILS



1Kg bag

Product code:	Gauge (mm)	Length (mm)
001194	2.65	50
001193	2.65	65
001195	3.75	75
001190	4.50	100
001191	5.60	125
001192	6.00	150

SQUARE TWIST NAILS



1kg bag
Galvanised

Product code:	Gauge (mm)	Length (mm)
001197	3.75	30
001198	3.75	40

SHARARDISED ANNULAR RING SHANK NAILS



1Kg bag

Product code:	Gauge (mm)	Length (mm)
001202	2.65	40
001203	2.65	50
001204	3.35	65
001205	3.75	75

EXTRA-LARGE HEAD CLOUT NAILS



1Kg bag
Galvanised

Product code:	Gauge (mm)	Length (mm)
001187	3.0	13
001188	3.0	20
001189	3.0	50

CLOUT NAILS



1Kg bag
Galvanised

Product code:	Gauge (mm)	Length (mm)
001183	2.65	25
001184	2.65	30
001185	2.65	40
001186	2.65	50

COPPER CLOUT NAILS



0.5Kg bag

Product code:	Gauge (mm)	Length (mm)
001180	2.65	40
001181	3.35	50

PRESSER POINT STAPLES



Galvanised
1Kg bag

Product code:	Gauge (mm)	Height (mm)
001199	2.0	20
001200	2.65	25
001201	4.0	40

SHARARDISED PANEL PINS



0.5Kg bags

Product code:	Gauge (mm)	Length (mm)
001206	1.60	25
001207	1.60	30
001208	1.60	40

SPRING HEAD NAILS

0.5Kg bag

Galvanised

Size: 3.35 x 65mm



Product code: 001196

DRIVE SCREW

1K bag

Galvanised

Size: 5.4 x 100mm



Product code: 001182

CUT FLOORING BRAD NAILS



0.5Kg bag
Bright
Size: 65mm

Product code: 001179

METAL SPEED PLUGS



Pack of 75
Complete with screws

Product code: 001209

OVAL NAILS



1Kg bag
Bright
Size: 40mm

Product code: 001178

ROUND LOST HEAD NAILS



1Kg bag
Bright
Size: 3.35 x 65mm

Product code: 001177

CUT CLASP NAILS



0.5Kg bag
Bright
Size: 6.5mm

Product code: 001176

ALUMINIUM CLOUT NAILS



0.25Kg bag
Size: 3.35 x 50mm

Product code: 001175

POP RIVETS



Material: Aluminium
Sold individually or in boxes of 250, 500 or 1000, depending on rivet size

Product code:	Diameter (mm)	Length (mm)	Flange
001580	3.2	6	Regular
001581	3.2	8	Regular
001582	3.2	10	Regular
001583	3.2	12	Regular
001584	4	10	Regular
001585	4	12	Regular
001586	4	16	Regular
001587	4.8	10	Large
001588	4.8	12	Large
001590	4.8	16	Large
001592	4.8	20	Large
001594	4.8	26	Large

FIXINGS





FIXINGS

We Cut Keys!

HOLLOW WALL ANCHOR	Product code:	Screw diameter (mm)	Anchor length (mm)	Hole diameter (mm)	Wall thickness (mm)
 <p>Provides a permanent threaded anchor in a cavity wall For use with a setting tool Sold individually Finish: Zinc plated</p>	000965	4	20	8	0 - 5
	000966	4	38	8	10 - 16
	000967	5	37	10	6 - 13
	000968	5	65	10	14 - 32

HEX FULL NUTS	
 <p>Zinc plated Sold individually or in boxed quantities</p>	
Product code:	Size (mm)
000783	3
000784	3.5
000785	4
000786	5
004478	6
004479	8
004477	10
000780	12
000781	16
000782	20
000790	24

NYLOC NUTS	
 <p>Zinc plated Sold individually or in boxed quantities</p>	
Product code:	Size (mm)
000791	3
000796	4
000797	5
000798	6
000799	8
000792	10
000793	12
000795	16

WING NUTS	
 <p>Zinc plated Sold individually</p>	
Product code:	Size (mm)
000802	4
000803	5
000804	6
000805	8
000800	10
000801	12

FIXINGS



FIXINGS

HEX FULL NUTS - A2 STAINLESS STEEL

Sold individually or in boxed quantities



Product code:	Size (mm)
000811	6 x 25
000812	8 x 25
000813	10 x 25

CONNECTING NUTS

Zinc plated
Sold individually



Product code:	Thread size (mm)	Length (mm)
000809	6	18
000810	8	24
000806	10	30
000807	12	36
000808	16	48

PRONGED TEE NUT



Zinc plated
Sold individually
Size: 6mm

Product code: 000814

REPAIR WASHERS

Zinc plated
Sold individually or in boxed quantities



Product code:	Size (mm)
000822	5 x 20
000823	5 x 25
004481	6 x 20
004482	6 x 25
000824	6 x 30
000825	6 x 38
000826	6 x 50
000827	8 x 25
000828	8 x 30
000829	8 x 38
000818	10 x 25
004480	10 x 30
000819	10 x 38
000820	12 x 38
000821	12 x 50

FORM A WASHER

Available individually or in boxed quantities
Zinc plated



Product code:	Hole size (mm)
004472	3
004473	4
004474	5
004475	6
004476	8
004467	10
004468	12
004469	16
004470	20
004471	24

SQUARE WASHERS



Galvanised
Sold individually
Sizes in stock:

Product code: 10 x 38mm: 000833
12 x 50mm: 000834

REPAIR WASHERS - A2 STAINLESS STEEL

Sold individually or in boxed quantities



Product code:	Size (mm)
000835	6 x 25
000836	8 x 25
000837	10 x 35

FIXINGS

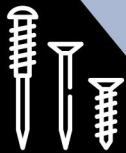

FIXINGS

SPRING WASHERS

Sold individually or in boxed quantities



Product code:	Hole size (mm)
009254	6
009998	8
009391	10
009258	12
009218	16

MACHINE SCREWS



Zinc plated
Sold individually

Product code:	Thread size (mm)	Length (mm)	Head type
000839	3	12	CSK
000840	3	20	CSK
000841	4	12	CSK
000842	4	20	CSK
000843	4	25	CSK
000844	4	50	CSK
000845	5	12	CSK
000846	5	20	CSK
000847	5	25	CSK
000848	5	40	CSK
000849	5	50	CSK
000874	5	70	CSK
000850	5	75	CSK
000838	5	100	CSK
000851	6	12	CSK
000852	6	20	CSK
000853	6	25	CSK
000854	6	40	CSK
000855	6	50	CSK
000856	6	70	CSK

Product code:	Thread size (mm)	Length (mm)	Head type
000857	3	12	Pan
000858	3	25	Pan
000859	4	12	Pan
000860	4	25	Pan
000861	4	40	Pan
000862	4	50	Pan
000863	5	12	Pan
000864	5	25	Pan
000865	5	40	Pan
000866	5	50	Pan
000867	5	60	Pan
000868	6	12	Pan
000869	6	20	Pan
000870	6	25	Pan
000871	6	40	Pan
000872	6	50	Pan
000873	6	80	Pan

SHEAR NUT

Galvanised

Size: 8mm

Sold individually



Product code: 000904

SELAWASHER



Product code:	Hole diameter (mm)	Washer diameter (mm)	Colour:
006948	6	28	Black
001441	8	28	Black
001442	8	28	Clear

SELA COVER



Product code:	Diameter (mm)	Colour
001443	28	Black
001444	28	Clear

DOWTY WASHER



Size: 8 x 30mm
Sold individually

Product code: 000905

FIXINGS



FIXINGS

HOOK BOLT

Finish: Zinc and yellow



Product code:	Size (mm)
000907	6 x 80
000906	6 x 100
000908	8 x 100
000909	8 x 140
000910	8 x 180

CIRCLIPS PACK



Internal sizes: 12 - 20mm
External sizes: 6 - 25mm

Product code: 001487

STEEL WASHER PACK



Sizes: M5 - M10
200 pce

Product code: 001491

SPLIT PIN PACK



175 pce

Product code: 001489

RUBBER WASHER PACK



Sizes: 5 - 14.5mm
120 pce

Product code: 001492

MASONRY NAILS PACK



Sizes: 20 - 40mm
200 pce

Product code: 001490

CRIMP TERMINALS PACK



82 pce

Product code: 001494

LOCKING NUTS PACK



Sizes: M4 - M12

Product code: 001495

CAP SCREWS & NUTS PACK



75 pce
Sizes: M5 x 20mm - M8 x 30mm

Product code: 004597



FIXINGS

FIXINGS

FIBRE WASHERS PACK



Sizes: 10 - 30mm
110 pce

Product code: 001500

MACHINE SCREWS & NUTS PACK



Sizes: M5 x 12mm - M6 x 25mm

Product code: 004679

'O' RINGS PACK



Sizes: 4.2 x 7.2mm - 15 x 23mm

Product code: 005289

ASSORTED FLANGE NUT PACK



78 pce
Sizes in pack: M5 - M12
Zinc plated

Product code: 005846

WING NUT PACK



Contains sizes M4 - M12
40 pce

Product code: 009948

ASSORTED RUBBER GROMMET PACK



35 pce
Sizes in pack: (2.5 x 10.5 x 6.5mm) - (16 x 29 x 7.5mm)

Product code: 005879

CABLE TIES



Sold in bags of 100

Product code	Tie thickness (mm)	Length (mm)	Colour
001137	2.5	100	Black
001138	2.5	100	Neutral
001139	4.8	160	Black
001140	4.8	160	Neutral
001141	4.8	200	Black
004587	4.8	200	Neutral
001142	4.8	300	Black
001143	4.8	300	Neutral
001144	4.8	370	Black
001145	4.8	370	Neutral
001146	9.0	530	Black
004564	9.0	530	Neutral



SEALANTS AND ADHESIVES

Mitchells
Ironmongers

SEALANTS & ADHESIVES

We Cut Keys!

Don't forget your Sealant Gun on page 134

STANDARD CONTRACTORS SEALANT

BEST SELLER



For general weatherproofing, sanitary and gap sealing applications

Quick curing, mould resistant

Size: 295ml

Product code:
White: 004456
Clear: 004455

LOW MODULUS CONTRACTORS SEALANT



Premium quality low modulus, non-corrosive neutral cure silicone sealant that adheres to virtually all substrates

Typically used for expansion joints and perimeter pointing of door and window frames

Size: 300ml

Product code:
White: 002587
Clear: 002582
Grey: 002580
Black: 002579
Brown: 002586

BATH AND SANITARY SEALANT



Premium quality, mid modulus acetoxycure silicone sealant

Contains a high level of anti-fungal compound to prevent mould and fungal growth

Tested to ISO 8339 and ISO 10590/10563

Size: 295ml

Product code:
White: 006934
Clear: 002581

ANTI-PICK SEALANT



High modulus, one part, chemically curing solvent free sealant

Specifically designed for providing a finger pick resistant seal accommodating small movement for areas where a normal sealant is not hard enough

Size: 295ml

Product code:
White: 002583

WEATHER-MATE SEALANT



Multi-use adhesive and gap filler based on advanced isocrylic formula

Can be applied in wet weather and will even stick to wet surfaces

Adheres to many problematic surfaces such as bitumen, lead, galvanised steel and roofing felts

Size: 295ml

Product code:
Clear: 002589

FOREVER WHITE/CLEAR SEALANT

BEST SELLER



Superior silicone sealant that is permanently waterproof and flexible and ideal for sealing shower bases, cubicles, wetrooms, baths, sinks and basins

Proven to protect against mould, mildew and bacterial growth to the sealant

Tested and certified to show no mould growth after more than 10 years

Size: 295ml

Product code:
White: 004458
Clear: 004457

INTUMESCENT SEALANT



Intumescent acrylic sealant that swells when exposed to temperatures above 125 degrees to prevent the passage of fire and smoke

Fire rating of up to 5 hours in certain joint configurations

Fire rated to EN 1366-4 (2006)

Acoustic rating to BS EN ISO 140/3
Tested for air permeability to EN 13141-1

Size: 295ml

Product code:
White: 002590

LEAD SEALANT



Excellent adhesion to metals

May be used over water and solvent based paints

Excellent external weathering properties

Certified to EN 15651

Size: 295ml

Product code:
Grey: 007765

DECORATORS CAULK - ONE HOUR



Fast drying flexible decorators filler and sealant

Remains permanently flexible

Can be overpainted with most paint types or covered with wallpaper, no sanding down required

Size: 310ml

Product code:
White: 002585

SEALANTS & ADHESIVES



SEALANTS & ADHESIVES

DECORATORS CAULK - CAULK ONCE	
	<p>Premium quality acrylic caulk Fast drying and permanently flexible Can be over painted in one hour Offers super adhesion, low shrinkage as well as tooling down smoothly Size: 380ml</p>
	<p>Product code: White: 002584</p>

PINKGRIP	
	<p>Will stick just about anything on a building site that needs sticking No need to pin under a work piece to prevent slumping Suitable for interior and exterior use 'Direct Bond' eliminates the need for double stick methods</p>
	<p>Product code: Regular (350ml): 004459 Solvent-free (380ml): 004462</p>

GRIPFILL	
	<p>Multi-purpose, high strength gap filling adhesive Will bond most building materials Superior final bond strength Suitable for interior and exterior use</p>
	<p>Product code: Regular (350ml): 004465 Solvent free (380ml): 004466</p>

CT1	
<p>BEST SELLER</p> 	<p>Will successfully bond metals (including lead), glass, mirrors, wood, and polystyrene The ultimate solution for sealing Excellent resistance to chemicals Prevents fungal growth UV resistant Excellent resistance to vibration Food safe - conforms to ISEGA Standards Works in wet or dry conditions Perfect for marine and boating maintenance, accident and emergency repairs Can be used in all salt-water environments Odourless Does not shrink Can be painted Contains no solvents No isocyanates Unique flexibility Environmentally compliant Instant repair and bonding with fibre glass and carbon fibre materials Size: 290ml</p>
	<p>Product code: White: 002578 Clear: 002576 Brown: 002575 Black: 002574 Grey: 002577</p>

STIXALL	
	<p>Superior combined building adhesive and sealant Bonds and seals virtually everything to anything in virtually all conditions, even under water or in rain Size: 290ml</p>
	<p>Product code: White: 004461 Clear: 004460</p>

GUN A NAIL	
	<p>High strength, gap filling multi-purpose building adhesive based on tackified solvent free system Wide variety of building and home improvement applications Can be used where at least one of the substrates to be bonded is porous Application temperature range: +4 to +40 degrees Celsius Size: 290ml</p>
	<p>Product code: White: 002588</p>

STICKS-LIKE ADHESIVE	
<p>BEST SELLER</p> 	<p>Bonds most surfaces Suitable for interior and exterior use Can be used under water and on damp surfaces Can be over painted Size: 290ml</p>
	<p>Product code: White: 004464</p>

SUPER-FAST PLUS ACTIVATOR	
	<p>Developed to instantly seal porous materials when used in conjunction with Super-fast plus adhesive</p>
	<p>Product code: 009509</p>

SEALANTS & ADHESIVES



SEALANTS & ADHESIVES

CONTACT ADHESIVE



Premium grade rubber-based contact adhesive. May be used internally and externally (apart from the 5L which is for internal use only)

Commonly used to bond decorative laminates, all types of wood, rigid PVC, ABS, leather, cork, linoleum, rubber, stone, metals and dense fabrics

Product code:
250ml: 002598
750ml: 002599
5L: 002600

MITRE FAST BONDING KIT

BEST SELLER



Two-part instant adhesive system comprising a cyanoacrylate adhesive and aerosol activator

Used when its instant bonding properties dramatically reduce assembly times for mitre joints as opposed to conventional wood adhesives

Suitable for but not limited to bonding timber, rubber, PVCu and metals

Product code:
002605

GATOR GLUE



Once applied, Gator Glue expands slightly on cure to form a virtually indestructible bond

Will set hard in approximately 30 minutes and sticks to wet surfaces

Can be used internally and externally and is 100% seawater proof

Can be used on most types of wood, formica, polystyrene foam, PU foam, glass wool, metal, stone, ceramics, porcelain, glass, concrete, brick, masonry and various plastics

Product code:
002609

INDUSTRIAL SUPERGLUE



10-15 seconds setting time

Solvent free

Bonds non-porous surfaces such as metals, most plastics, glass, PVCu, rubber and EPDM

Size: 20g

Product code:
002604

SUPER-FAST PLUS ADHESIVE - 20ML



Adhesive which bonds in seconds and has special formula based on Cyanacrylate

Does not contain solvent

Temperature resistant from 30 to 100 degrees

Resistant to solvents

No heating - no soldering - no mixing

Colourless

Provides an exceptionally strong bond between almost all kinds of materials, except for polyethylene, polypropylene and fluorine containing plastic materials

Use with Super-fast plus activator for instant adhesion

Product code:
009510

THREADLOCK



Allows for disassembly

For nuts, bolts, screws and threads

Can be used on oil contaminated parts

Size: 10g

Product code:
002693

SEALANTS & ADHESIVES



ARALDITE	
	<p>Strong, long lasting, solvent free adhesive</p> <p>Can be sanded or painted</p> <p>Parts repositionable for 4 minutes</p> <p>Size: 2 x 15ml tubes</p>
<p>Product code: 002611</p>	

IMPACT ADHESIVE	
	<p>One-part contact adhesive</p> <p>Bonds most material, even non-porous such as metals</p> <p>Size: 65g</p>
<p>Product code: 002617</p>	

CONTACT ADHESIVE	
	<p>Sprayable glue which bonds to most common materials including wood, concrete, stone, tiles, rubber, foam, metals, rigid plastics, canvas fabrics, cardboard, paper and cork</p> <p>Size: 500ml</p>
<p>Product code: 002603</p>	

ALL-PURPOSE WOOD ADHESIVE	
	<p>Weatherproof</p> <p>Can be used internally and externally</p> <p>Sets in 10 minutes</p> <p>Suitable for general woodworking and joinery uses</p>
<p>Product code: 500ml: 002608 5L: 002596</p>	



LUMBERJACK WOOD ADHESIVE	
	<p>Sets hard in 45 minutes</p> <p>100% seawater proof</p> <p>Product foams slightly on application to fill small gaps</p> <p>Exceptionally high bond strength</p> <p>Size: 750ml</p>
<p>Product code: 002602</p>	

D4 WOOD ADHESIVE	
	<p>Suitable for interior and exterior use</p> <p>Waterproof</p> <p>Dries clear</p> <p>Size: 1L</p>
<p>Product code: 002601</p>	

SEALANTS & ADHESIVES



SEALANTS & ADHESIVES

PVA BOND		CASCAMITE ADHESIVE	
	<p>Multi-purpose bonding agent, primer, sealer, cement and plaster ad-mixture</p> <p>Conforms to BS 5270</p>		<p>Specially formulated for exterior joinery exposed to the weather</p> <p>Attains bond strength very fast, enabling it to be used for load bearing and laminating. Use internally and externally where high bond strength/gap filling/water resistance is required</p>
	<p>Product code: 1L: 002606 5L: 002607</p>		<p>Product code: 125g: 002612 500g: 002613</p>

EXPANDING FOAM	Product code	Foam type	Application	Tube volume (ml)
 <p>Good adhesion to most building materials</p>	001133	General Purpose	Hand	750
	001132	General Purpose	Gun	750
	001124	Fire foam	Hand	750
	001131	Fire foam	Gun	750

FOAM GUN PU CLEANER	SILICONE EATER
 <p>Prevents clogging of foam guns after use</p> <p>Volume: 500ml</p>	 <p>Revolutionary chemical that breaks up and removes all types of silicone sealant</p> <p>Size: 100ml</p>
<p>Product code: 001136</p>	<p>Product code: 009641</p>



HAND TOOLS

Mitchells
Ironmongers

HAND TOOLS



HAND TOOLS



CLAW HAMMER - HICKORY SHAFT



Size: 20oz

Product code: 002306

OX TRADE CLAW HAMMER



Size: 20oz

Product code: 001960

OX PRO CLAW HAMMER - FIBREGLASS SHAFT



Non-slip grip handle with shock reduction
Size: 20oz

Product code: 001911

OX PRO CLAW HAMMER



Non-slip grip handle with shock reduction
Sizes in stock:

Product code: 16oz: 001906
20oz: 001907

DOUBLE ENDED SCUTCH HAMMER



Used in the preparation of a surface prior to rendering
Soft grip handle
Size: 20oz

Product code: 002040

ROUGHNECK CLAW HAMMER



Size: 20oz
Tubular shaft
Weight: 567g

Product code: 002032

OX PRO BRICK HAMMER



Size: 24oz

Product code: 001915

OX PRO DRYWALL HAMMER



Crowned, scored hammer head to reduce the chance of impact marks on plasterboard
Size: 14oz

Product code: 001916

CROSS PEIN PIN HAMMER - HICKORY SHAFT



Manufactured to BS 876
Size: 4oz

Product code: 002310

ANTI-SHOCK CLAW HAMMER



Size: 20oz
Magnetic nail holder
Weight: 570g

Product code: 002034

BALL PEIN HAMMER - FIBREGLASS SHAFT



Size: 32oz
Weight: 908g

Product code: 002038

BALL PEIN HAMMER - FIBREGLASS SHAFT



Size: 16oz
Weight: 454g

Product code: 002037

HAND TOOLS



<p>DOUBLE SCUTCH HAMMER - HICKORY HANDLE</p>	<p>SLATERS HAMMER</p>	<p>CARPENTERS MALLET</p>
 <p>For dressing bricks and masonry Replaceable combs and chisel bits 25mm</p>	 <p>Pointed at one end for making holes in slates Centre claw for pulling nails Weight: 454g</p>	 <p>Size: 115mm Weight: 470g</p>
<p>Product code: 002314</p>	<p>Product code: 002041</p>	<p>Product code: 002307</p>
<p>COPPER/HIDE HAMMER</p>	<p>NYLON HAMMER</p>	<p>JUNIOR THORLITE RUBBER FACED HAMMER</p>
 <p>Diameter: 38mm Weight: 1070g</p>	 <p>Sizes in stock:</p>	 <p>Diameter: 38mm Weight: 283g</p>
<p>Product code: 002362</p>	<p>Product code: 32mm: 002362 38mm: 002363</p>	<p>Product code: 002364</p>
<p>OX PRO WHITE RUBBER MALLET</p>	<p>OX TRADE COMBINATION RUBBER MALLET</p>	<p>BLACK RUBBER MALLET</p>
 <p>Sizes in stock:</p>	 <p>Size: 24oz</p>	 <p>Size: 24oz</p>
<p>Product code: 16oz: 001912 24oz: 001913 32oz: 001914</p>	<p>Product code: 001959</p>	<p>Product code: 007264</p>
<p>OX TRADE FIBREGLASS HANDLE CLUB HAMMER</p>	<p>OX PRO CLUB HAMMER</p>	<p>MICRO FIBREGLASS HANDLE PICK MATTOCK</p>
 <p>Extremely strong fibreglass handle Size: 4lb</p>	 <p>Hardened high quality steel Extremely strong fibreglass handle Sizes in stock:</p>	 <p>Size: 400g</p>
<p>Product code: 001958</p>	<p>Product code: 3lb: 001917 4lb: 001918</p>	<p>Product code: 002042</p>

HAND TOOLS



HAND TOOLS

We Cut Keys!

ESTWING ULTRA FRAMING HAMMER

Extra notch built into the head along with a magnetic nail starter

Traditional leather handle grip

Weight: 19oz

Length: 349mm



Product code: 002393

ESTWING CURVED CLAW HAMMER

Traditional leather grip handle

Weight: 20oz



Product code: 002394

ESTWING CURVED CLAW HAMMER

Vinyl grip

Sizes in stock:



**Product code: 16oz: 002395
20oz: 002397**

ESTWING STRAIGHT CLAW HAMMER

Vinyl grip

Weight: 20oz



Product code: 002398

ESTWING BRICK HAMMER

Vinyl grip

Weight: 20oz



Product code: 002396

HAMMER WEDGES - ASSORTED PACK



Contents:
2 x size 1 steel wedges and one wooden wedge
2 x size 2 steel wedges and one wooden wedge
2 x size 3 steel wedges and one wooden wedge
2 x size 4 steel wedges and one wooden wedge

Product code: 004921

SILVERLINE MEASURING TAPE



Size: 5m

Product code: 002550

OX TRADE TAPE MEASURE



25mm wide blade
Sizes in stock:

**Product code: 5m: 001953
8m: 001954**

Tylon™ Pocket Tape

BEST SELLER



Metric and imperial measurements
Sizes in stock:

**Product code: 3m: 002097
5m: 009525 8m: 009524**

POWERLOCK® CLASSIC POCKET TAPE



Metric and imperial measurements
Sizes in stock:

**Product code: 5m: 002103
8m: 002102 10m: 002099**

FATMAX® PRO POCKET TAPE



Metric and imperial graduations
Sizes in stock:

**Product code: 5m: 002136
8m: 002137 10m: 002138**

FATMAX® AUTOLOCK POCKET TAPE

Blade width: 32mm

Patented reverse lock mechanism for greater control and increased blade life

Metric and imperial graduations

Sizes in stock:



**Product code: 5m: 002100
8m: 002101**

HAND TOOLS



BRICK-MATE TAPE

Accurately calculates brick and block quantities

Metric

Blade length: 8m
Blade width: 25mm



Product code: 009647

SITE PRO FIBREGLASS TAPE

Features both metric and imperial or metric only measurements on a white blade

Blade Width: 13mm

Accuracy: EC Class II



Product code: 002041

OPEN FRAME GEARED TAPES



Product code	Blade width (mm)	Blade length (m)	EC Class
002709	13	30	II
002145	15	50	III
002140	13	100	II

TRUE LASER MEASURE - 30M

Can measure length, area, volume

Accuracy: ±2mm

Operating Range: 0.1-30m

Power Supply: 2 x AAA Batteries (Included)



Product code: 002082

WHITE NYLON RULE

Bevelled edges for precise marking

Imperial and metric

Length: 1000mm



Product code: 002158

WOODEN 4-FOLD RULE

A hardwood four-fold rule with brass hinges and brass end caps

Imperial markings one side and metric markings on the other

Length unfolded: 1000mm

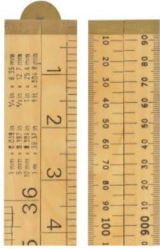

Product code: 009564

STAINLESS STEEL RULE

A general-purpose rule made of stainless steel with clear, permanent, etched graduations

Lengths in stock:

Product code: 600mm: 002157
300mm: 002156 150mm: 002155



ALUMINIUM RULE WITH HANDLE

Metric and imperial

Length: 1200mm



Product code: 002539

OX TRADE FEATHER EDGE

Combined feather edge & straight edge

Size: 1800mm



Product code: 001857

DUAL COLOUR QUICK SQUARE

Sizes in stock:

Product code: 175mm: 002129
300mm: 002130



STEEL ROOFING SQUARE

Size: 400 x 600mm









Product code: 002148

HAND TOOLS

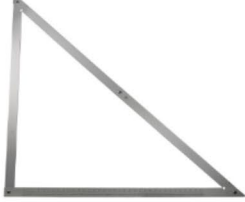
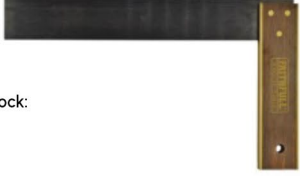

HAND TOOLS

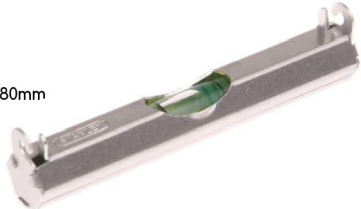

<p>ENGINEERS SQUARE</p>	<p>HEAVY-DUTY ALUMINUM FOLDING SQUARE</p>	<p>CARPENTERS TRY SQUARE</p>
<p>Durable hardened steel blade Size: 150mm</p> 	<p>Complete with a carry case Size: 1200mm</p> 	<p>Sizes in stock:</p> 
<p>Product code: 002543</p>	<p>Product code: 002141</p>	<p>Product code: 300mm: 002146 230mm: 002147</p>
<p>BASIC COMBINATION SQUARE</p>	<p>COMBINATION SQUARE</p>	<p>ADVANCED COMBINATION SQUARE</p>
<p>Size: 300mm</p> 	<p>Size: 300mm</p> 	<p>Size: 300mm</p> 
<p>Product code: 002150</p>	<p>Product code: 002149</p>	<p>Product code: 002154</p>
<p>SLIDING BEVEL</p>	<p>MORTICE GAUGE - SLIDE ADJUSTMENT</p>	<p>MARKING GAUGE</p>
<p>Length: 230mm</p> 		
<p>Product code: 002144</p>	<p>Product code: 002143</p>	<p>Product code: 002142</p>
<p>PLASTIC 2D LEVEL</p>	<p>POST LEVEL</p>	<p>LINE LEVEL</p>
<p>Two vials set at right angles to enable all planes to be levelled in one action</p> 	<p>Built-in magnets for use on metal posts and surfaces Supplied with heavy-duty elastic</p> 	<p>Length: 80mm</p> 
<p>Product code: 002167</p>	<p>Product code: 002114</p>	<p>Product code: 002104</p>

HAND TOOLS



<p>TORPEDO LEVEL - MAGNETIC BASE</p>	<p>MAGNETIC TORPEDO LEVEL IN HOLSTER</p>	<p>MAGNETIC TORPEDO LEVEL</p>	
<p>Length: 220mm</p> 	<p>Size: 250mm</p> 	<p>Size: 230mm</p> 	
<p>Product code: 007742</p>	<p>Product code: 002166</p>	<p>Product code: 002105</p>	
<p>OX TRADE TORPEDO LEVEL</p>	<p>OX PRO TORPEDO LEVEL</p>	<p>OX PRO SPIRIT LEVEL</p>	
<p>Size: 250mm</p> 	<p>3 Unbreakable Acrylic Shock -Proof Vials</p> <p>Size: 250mm</p> 	<p>Unique dual view Shock proof end caps</p> 	
<p>Product code: 007795</p>	<p>Product code: 001900</p>	<p>Product code:</p>	<p>Length (mm)</p>
<p>STABILA DOUBLE PLUMB SPIRIT LEVEL</p>	<p>FatMax® Pro Box Beam Spirit Level - 3 Vial</p>	<p>001891</p>	<p>600</p>
<p>Sizes in stock:</p> 	<p>Sizes in stock:</p> 	<p>001892</p>	<p>900</p>
<p>Product code: 400mm: 002162 600mm: 002163 900mm: 002164 1200mm: 002165</p>	<p>Product code: 600mm: 002106 900mm: 002107 1200mm: 002108</p>	<p>001893</p>	<p>1200</p>
<p>R-TYPE SPIRIT LEVEL</p>	<p>OX PRO CYAN BRICK LINE</p>	<p>001894</p>	<p>1800</p>
<p>Developed for the toughest building site conditions</p> <p>Lengths in stock:</p> 	<p>High visibility material</p> <p>Size: 100m</p> 	<p>001895</p>	<p>2000</p>
<p>Product code: 800mm: 002170 1000mm: 002168 1200mm: 002169</p>	<p>Product code: 001929</p>	<p>MASONS BRAIDED NYLON LINE</p> <p>Not affected by mortar, mildew, oil and will not absorb water</p> <p>Length: 76.2m</p> <p>Colours in stock:</p> 	
		<p>Product code: Yellow: 002348 Pink: 002347</p>	

HAND TOOLS



We Cut Keys!



<p>LINE BLOCKS & LINE</p> <p>Contents: Two line blocks and 18m line</p>  <p>Product code: 002334</p>	<p>OX PRO CHALK LINE REEL</p> <p>High impact body Stainless steel hook Dual use - Can be used as a plumb bob Size: 30m</p>  <p>Product code: 001955</p>	<p>CHALKOMATIC</p> <p>Length: 30m</p>  <p>Product code: 002110</p>
<p>POWER WINDER LINE, CHALK & LEVEL</p> <p>30m kit</p>  <p>Product code: 002113</p>	<p>PRO CHALK LINE AND BLUE CHALK</p> <p>Length: 30m</p>  <p>Product code: 002020</p>	<p>CHALK POWDER</p> <p>Size: 250g Colours in stock:</p>  <p>Product code: Blue: 002309 Red: 002311 White: 002312 Yellow: 00231</p>
<p>BUILDERS LINE PIN</p> <p>Length: 155mm Twinpack</p>  <p>Product code: 002340</p>	<p>YELLOW CRAYON - TWINPACK</p>  <p>Ideal for use on timber, metal, ceramics and concrete</p> <p>Product code: 002359</p>	<p>FINE TIP MARKER BLACK</p>  <p>Pack of 2</p> <p>Product code: 002111</p>
<p>CHISEL TIP MARKER BLACK</p>  <p>Pack of 2</p> <p>Product code: 002112</p>	<p>HOLE MARKING KIT</p> <p>Complete deep hole marker kit 120mm retractable and interchangeable pencil leads</p>  <p>Product code: Pencil only: 009387 Pen only: 009821 Lead pack of 6: 009421 Whole kit: 009187</p>	<p>MINI FINE TIP PEN</p> <p>Available in black, red, green and blue Permanent</p>  <p>Product code: 009513</p>

HAND TOOLS



<p>OX PRO BRICK TROWEL PHILADELPHIA PATTERN</p>	<p>OX PRO POINTING TROWEL PHILADELPHIA PATTERN</p>	<p>OX PRO BUCKET TROWEL</p>
<p>Precision tapered ground blade Hard end handle for tapping in bricks Sizes in stock:</p> 	<p>Sizes in stock:</p> 	<p>High quality carbon steel Hard end handle for tapping in bricks Size: 180mm</p> 
<p>Product code: 250mm: 001865 280mm: 001866 300mm: 001867</p>	<p>Product code: 102mm: 001886 127mm: 001887 152mm: 001888</p>	<p>Product code: 001881</p>
<p>OX PRO MARGIN TROWEL</p>	<p>OX PRO SMALL TROWEL/MINI PLASTERING TROWEL</p>	<p>OX PRO STAINLESS-STEEL PLASTERERS TROWEL</p>
<p>High quality carbon steel Size: 125 x 50mm</p> 	<p>Lightweight but very strong aluminum shank Size: 8" x 3"</p> 	<p>Pre-worn edges to eliminate line & ripple marks Sizes in stock:</p> 
<p>Product code: 001880</p>	<p>Product code: 001882</p>	<p>Product code: 280mm: 001862 356mm: 001863 457mm: 001864</p>
<p>OX PRO CEMENT FINISHING TROWEL</p>	<p>OX PRO DRY WALL EXTERNAL CORNER TROWEL</p>	<p>OX PRO DRY WALL INTERNAL CORNER TROWEL</p>
<p>Stainless steel blade Size: 400mm</p> 	<p>Flexible stainless-steel blade 90° Radius Size: 100 x 125mm</p> 	<p>Flexible stainless-steel blade Flexes for perfect 90° corners Size: 102 x 127mm</p> 
<p>Product code: 001890</p>	<p>Product code: 001875</p>	<p>Product code: 001874</p>
<p>OX PRO MAGNESIUM FLOAT</p>	<p>OX PRO POINTED FLOORING TROWEL</p>	<p>OX PRO NOTCH TROWEL</p>
<p>Heavy duty magnesium blade Bevelled ends and rounded blade Size: 400mm</p> 	<p>Stainless steel blade Size: 16"</p> 	<p>Carbon steel blade Notch sizes</p> 
<p>Product code: 001879</p>	<p>Product code: 001889</p>	<p>Product code: 8mm: 001947 10mm: 001948 12mm: 001949</p>

HAND TOOLS



HAND TOOLS



CARPENTERS PENCILS

Sold individually
Colours in stock:



Product code: Blue: 002299
Green: 002300 Red: 002301

ENGINEERS SCRIBER

Features one straight end and one 90-degree end
For scoring metal, laminates and plastics



Product code: 002565

CENTRE PUNCH

Size: 6mm
Length: 150mm



Product code: 002297

AUTOMATIC CENTRE PUNCH

Ideal for making light indents without the use of a hammer

Tip diameter: 4mm
Length: 100mm



Product code: : 002308

NAIL PUNCH SET

Contents: 0.8, 1.6 & 2.4mm



Product code: 002006

BRADAWL - BEECH HANDLE

Size: 34.9mm
Tip size: 3.1mm



Product code: : 002349

PUNCH AND CHISEL SET

Contains:
3 x Cold Chisels:
10, 12, 16mm

6 x Parallel Pin Punches:
1.5, 3, 4, 5, 6, 8mm

1 x Taper Punch: 2mm

2 x Centre Punches:
6, 8mm



Product code: 002008

PARALLEL PIN PUNCH SET



Sizes: 1.5, 3, 4, 5, 6 and 8mm

Product code: 002007

OX TRADE GAUGING TROWEL

Size: 180mm



Product code: 001951

OX TRADE BRICK TROWEL PHILADELPHIA PATTERN

Size: 280mm



Product code: 001950

OX TRADE POINTING TROWEL

Size: 152mm



Product code: 001952

OX PRO GAUGING TROWEL

High quality carbon steel
Hard end handle for tapping in bricks

Size: 180mm



Product code: 001868

HAND TOOLS



OX PRO TELESCOPIC UNIVERSAL POLE



Size: 1350 - 3500mm
 Heavy duty lightweight telescopic pole
 Universal steel thread
 Rubber hand grip for ultimate comfort

Product code: 008231

OX PRO UNIVERSAL POLE ATTACHMENT



Fully compatible with all standard professional 'threaded' extension poles
 Constructed from 'tough glass filled' nylon
 Compatible with all sizes of speedskim

Product code: 008232

OX PRO SPEEDSKIM



Revolutionary tool system
 Designed to increase meterage output and enhance quality
 Significantly reduces harmful effects of fatigue & RSI
 Ultra-fine 0.3mm stainless steel blade
 Fine finishing of plaster, drywall & tape & jointing
 Compatible with all gypsum-based finishing plasters
 Complete with integral blade guard

Product code	Length (mm)
008235	600
008234	900
008233	1200

OX PRO SPEEDSKIM SEMI FLEXIBLE PLASTERING RULE



Speedskim is the revolutionary new tool system designed to increase meterage output and enhance quality of finish while significantly reducing the harmful effects of fatigue & RSI
 Flattening, finishing & ruling off
 Compatible with all gypsum-based plasters (hand and spray applied), traditional sand & cement renders and insulated rendering systems
 Complete with integral blade guard

Product code	Length (mm)
008238	600
008237	900
008236	1200

HAND TOOLS



HAND TOOLS



OX PRO ALUMINIUM PLASTERERS HAWK SOFT GRIP

High quality tempered aluminium blade
Size: 325 x 325mm

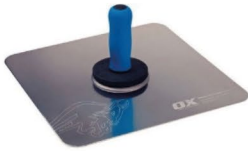

Product code: 001861

OX PRO TAPING KNIFE

High quality flexible stainless-steel blade
Strong aluminium back
Size: 250mm



Product code: 001879

OX PRO SMALL TOOL

Sizes in stock:



Product code: 13mm: 001858
16mm: 001859 19mm: 001860

OX PRO JOINT KNIFE

Flexible stainless-steel blade
Built-in hammer end
Sizes in stock:



Product code: 102mm: 001878
76mm: 001877 50mm: 001876

OX PRO TUCK POINTER



Product code:	Blade width (mm)	Blade length (mm)
001869	8	171
001870	10	171
001871	12	171
001872	19	171
001873	25	171

OX PRO PLASTERERS FLOAT

Non-absorbent
Pattern face
Sizes in stock:



Product code: 280 x 110mm: 001884
350 x 150mm: 001885

OX PRO SPONGE FLOAT

30mm
Hydro-sponge
Pad
Size:
140mm x 280mm



Product code: 001933

OX PRO BRICK JOINT RAKER



Product code: 001901

OX PRO GROUT REMOVER

Tungsten carbide
tipped blade
Storage compartment
in the hilt



Product code: 001852

OX PRO GROUT REMOVER REPLACEMENT BLADE

Tungsten carbide
tipped 50mm blade



Product code: 001853

OX TRADE CROSS SHAPED TILE SPACERS



Bags of 250
Sizes in stock:





Product code: 2mm: 001976
3mm: 001977 5mm: 001978

HAND TOOLS

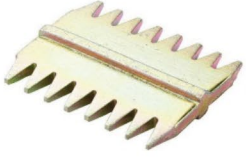

<p>OX PRO MIXING PADDLE</p>	<p>STANDARD MIXING PADDLE</p>	<p>OX SCUTCH COMB - 4 PACK</p>
<p>Hex shaft Sizes in stock:</p> 	<p>For use with electric drills Requires a 10mm or larger chuck Size: 100 x 600mm</p> 	<p>To fit into a scutch comb holder For preparation of surface prior to re-rendering Sizes in stock:</p> 
<p>Product code: 80x400mm: 001930 100x600mm: 001931 120x600mm: 001932</p>	<p>Product code: 007878</p>	<p>Product code: 50mm: 001910 38mm: 001909 25mm: 001908</p>

<p>MARSHALLTOWN BRICK JOINTER</p>	<p>Product code:</p>	<p>Size (inches)</p>	<p>OX PRO BRICK JOINTER</p>	<p>Product code:</p>	<p>Joint sizes (mm)</p>
	<p>002343</p>	<p>1/2 & 5/8"</p>	 <p>For a professional finish to joints between bricks</p>	<p>001905</p>	<p>10 & 13</p>
	<p>002344</p>	<p>3/4 & 7/8"</p>		<p>001902</p>	<p>13 & 16</p>
	<p>002345</p>	<p>5/8 & 3/4"</p>		<p>001904</p>	<p>16 & 19</p>
	<p>002346</p>	<p>3/8 and 1/2"</p>		<p>001903</p>	<p>19 & 22</p>







<p>FOLDING POCKET KNIFE</p>	<p>OX TRADE RETRACTABLE UTILITY KNIFE</p>	<p>OX PRO FIXED BLADE FOLDING KNIFE</p>
	 <p>Accepts most standard utility blades Blade storage in handle</p>	 <p>Compact foldable design Blade storage in handle Complete with 2 blades</p>
<p>Product code: 002088</p>	<p>Product code: 001979</p>	<p>Product code: 001846</p>

<p>OX PRO HEAVY-DUTY RETRACTABLE KNIFE</p>	<p>STANLEY LIGHTWEIGHT RETRACTABLE KNIFE</p>	<p>STANLEY ORIGINAL RETRACTABLE KNIFE</p>
 <p>Magnetic tip Storage for blades - 10 blades included</p>		<p>BEST SELLER</p>  <p>Length: 155mm</p>
<p>Product code: 001935</p>	<p>Product code: 007676</p>	<p>Product code: 002126</p>

HAND TOOLS



HAND TOOLS

<p>STANLEY SPRINGBACK SAFETY KNIFE</p>	<p>STANLEY SNAP-OFF BLADE KNIFE</p>	<p>FATMAX FIXED BLADE UTILITY KNIFE</p>	
	 <p>Size: 9mm</p>		
<p>Product code: 002086</p>	<p>Product code: 002087</p>	<p>Product code: 002089</p>	
<p>STANLEY SLIDING POCKET KNIFE</p>	<p>FATMAX RETRACTABLE TWIN BLADE KNIFE</p>	<p>FATMAX SPRING ASSISTED KNIFE</p>	
 <p>One handed knife operation</p>			
<p>Product code: 004100</p>	<p>Product code: 002090</p>	<p>Product code: 009527</p>	
<p>BAHCO SQUEEZE KNIFE</p>	<p>OPINEL KNIFE</p>	<p>Product code:</p>	<p>Total length (inches)</p>
<p>Complete with 6 blades</p> <p>Section for blade storage</p> 	 <p>High carbon steel blade Beech handle</p>	<p>004096</p>	<p>6.5"</p>
<p>Product code: 002298</p>		<p>004097</p>	<p>7"</p>
		<p>004098</p>	<p>7.5"</p>
		<p>004099</p>	<p>8"</p>
<p>HEAVY-DUTY KNIFE BLADES</p>	<p>OX PRO HEAVY-DUTY KNIFE BLADES & DISPENSER</p>	<p>HOOKED KNIFE BLADES</p>	
	<p>Sizes in stock:</p> 		
<p>Product code: Pack of 10 - 002128 Pack of 20 - 002125</p>	<p>Product code: 10 pack: 001936 100 pack: 001937</p>	<p>Pack of 5</p> <p>Product code: 002092</p>	

HAND TOOLS



HAND TOOLS

STRAIGHT KNIFE BLADES



Pack of 3

Product code: 002091

SAW BLADE FOR METAL



Product code: 002093

SNAP-OFF BLADES



Pack of 5
To fit the Stanley snap-off knife

Product code: 002127

SCRAPER BLADE



Product code: 002096

STANLEY 12 PIECE MULTI-TOOL



Product code: 002122

SILVERLINE HACKSAW



Aluminium frame
Carbon steel blade
Blade length: 300mm

Product code: 002569

BAHCO ALL-ROUND HACKSAW



Lightweight 2-component frame
Alternative 55-degree pin mount to allow flush cutting
Blade length: 300mm

Product code: 002122



LEATHERMAN - SIGNAL

Closed length: 11.43cm

Weight: 212g

Contains:

- Needlenose pliers
- Regular pliers
- 154cm replaceable wire cutters
- 154cm replaceable hard wire cutters
- Wire stripper
- 420HC combo knife
- Saw
- Hammer
- Awl with thread loop
- Can opener
- Bottle opener
- 1/4" hex bit driver
- Bit wrench
- 1/4" box wrench
- Carabiner
- 3/16" box wrench
- Safety whistle
- Ferrocium rod
- Diamond coated sharpener

Product code: 004426

Other Leatherman's available to special order

HAND TOOLS



HAND TOOLS

We Cut Keys!



<p>OX PRO HIGH-TENSION HACKSAW</p>	<p>BAHCO PRO HACKSAW</p>	<p>BAHCO ERGO HACKSAW</p>
 <p>Quick change blade design Blade length: 300mm</p>	 <p>Lightweight 2-component frame Alternative 55-degree pin mount to allow flush cutting Blade length: 300mm</p>	 <p>Ergonomically designed with very high blade tension Alternative 55-degree blade mounting to allow flush cutting Blade length: 300mm</p>
<p>Product code: 007771</p>	<p>Product code: 002414</p>	<p>Product code: 002415</p>
<p>BI-METAL HACKSAW BLADES</p>	<p>BAHCO 244 TRADE HAND SAW</p>	<p>BAHCO TOOLBOX SAW</p>
 <p>Virtually unbreakable and shatterproof Suitable for all kinds of metal sawing Sold individually</p>	<p>BEST SELLER</p>  <p>Size: 550mm</p>	 <p>11tpi Size: 380mm</p>
<p>Product code: 18tpi: 002418 24tpi: 002419</p>	<p>Product code: 009847</p>	<p>Product code: 002429</p>
<p>BAHCO XT HARDPOINT HANDSAW</p>	<p>FATMAX® HEAVY-DUTY HANDSAW</p>	<p>FATMAX® FINE CUT HANDSAW</p>
 <p>Thicker blade than a conventional saw for significantly faster cutting performance Size: 550mm</p>	 <p>Size: 550mm 7tpi</p>	 <p>Size: 550mm 11tpi</p>
<p>Product code: 002408</p>	<p>Product code: 002132</p>	<p>Product code: 002131</p>
<p>BAHCO INSULATION SAW</p>	<p>BAHCO LAMINATOR SAW</p>	<p>BAHCO TENON SAW</p>
 <p>New waved toothing Size: 550mm</p>	 <p>Specifically designed for cutting laminated and wooden flooring Size: 500mm</p>	 <p>13 tpi Size: 300mm</p>
<p>Product code: 002431</p>	<p>Product code: 002430</p>	<p>Product code: 002424</p>

HAND TOOLS



HAND TOOLS

BAHCO BLOCK SAW



For sawing lightweight concrete blocks
Size: 650mm
2 tpi

Product code: 002409

BAHCO PRUNING SAW



6 tpi
Size: 360mm

Product code: 002417

BAHCO COMPASS SAW



Suitable for all kinds of wood and plastic
9 tpi
Size: 300mm

Product code: 002428

BAHCO MINI SAW



Size: 250mm

Product code: 002402

BAHCO JUNIOR HACKSAW



Blade length: 150mm

Product code: 002407

BAHCO MINI HACKSAW



Blade length: 150mm

Product code: 002410

JUNIOR HACKSAW BLADES



10 pack

Product code: 002403

BAHCO DRYWALL SAW



8 tpi
Size: 160mm

Product code: 002432

COPING SAW



Size: 165mm
14 tpi

Product code: 002411

COPING SAW BLADES



5 pack
Size: 165mm
14 tpi

Product code: 002412

PADSAW



Complete with 2 blades
Length: 250mm

Product code: 002433

BAHCO DOVETAIL SAW



13 tpi
Size: 250mm

Product code: 002426

HAND TOOLS



HAND TOOLS



BAHCO PULL SAW



For fine, cross and angle cuts
13.5 tpi
Size: 300mm

Product code: 002427

BAHCO FOLDING PRUNING SAW



Size: 190mm

Product code: 002417

BAHCO BOWSAW



Sizes in stock:

**Product code: 530mm: 002416
600mm: 002400 755mm: 002401**

BOWSAW BLADES



Product code:	Length (mm)	Wet or Dry cut
002406	755	Wet
002423	755	Dry
002405	600	Wet
002422	600	Dry
002404	530	Wet
002421	530	Dry

PLASTIC MITRE BOX



Size: 300 x 90mm
Angles: 90, 45 and 22.5 degrees

Product code: 002474

MITRE BOX



Box length: 305mm
Box width: 115mm

Product code: 002186

OX TRADE COLD CHISEL



Product code:	Size (mm)
001971	13 x 150
001975	20 x 450
001974	20 x 300
001973	20 x 250
001972	20 x 200
001963	25 x 450
001962	25 x 300
001962	25 x 250

OX PRO BRICK CHISEL



Sizes in stock:

**Product code: 3 x 8.1/2": 001925
4 x 8.1/2": 001926**

OX TRADE BRICK BOLSTER



Sizes in stock:

**Product code: 100mm: 001969
75mm: 001968**

OX TRADE BRICK BOLSTER WITH GUARD



Sizes in stock:

**Product code: 100mm: 001966
75mm: 001965**

HAND TOOLS



HAND TOOLS

OX PRO FLOOR CHISEL



Size: 3" x 11"

Product code: 001924

OX PRO SCUTCH COMB HOLDER



For detachable stone dressing combs
Sizes in stock:

**Product code: 25mm: 001921
38mm: 001922**

OX PRO ELECTRICIANS CHISEL



Size: 2.1/4" x 10"

Product code: 001923

OX TRADE PLUGGING CHISEL



Size: 230 x 6mm

Product code: 001970

OX HEAVY DUTY WOOD CHISEL



Product code:	Blade width (mm)
001938	6
001945	10
001940	16
001946	19
001941	22
001942	25
001943	32
001944	38

FATMAX® FOLDING POCKET CHISEL



Size: 25mm

Product code: 002095

MARPLES SPLIT-PROOF CHISEL SET

BEST SELLER



Contents: 6, 10, 12, 19, 25, 32, 38 and 50mm

Product code: 009514

MARPLES CHISEL SET



Contents: 6, 10, 12, 19, 25, 32, 38 and 50mm

Product code: 009528

OILSTONE OIL & HONING GUIDE



Contains sharpening stone, bottle of lubricating oil and a honing guide

Product code: 002094

CIGAR SHARPENING STONE



Ideal for sharpening any axe, scythe or gardening tool
Size: 300mm

Product code: 002478

DIAMOND FILE CARD SET - 3 PCE



Suitable for moistened or dry use
For sharpening pocket knives, chisels, router cutters and small hand tools
Fine, medium and coarse grades

Product code: 002494

HAND TOOLS



HAND TOOLS

OX PRO HEAVY-DUTY AVIATION SNIPS

Extra heavy-duty.
Heat-treated alloy jaws
Types in stock:



Product code: straight: 001856
left-handed: 001854 right-handed: 001855

PLIER SET



Product code: 002279

VDE PLIER SET



Individually tested to 10,000V
Conforms to DIN EN60900

Product code: 002277

COMBINATION PLIERS



Size: 175mm

Product code: 002378

LONG NOSE PLIER



Cable cutter for up to 1.6mm cables
Sizes in stock:

Product code: 150mm: 002369
200mm: 002370

BENT SNIPE NOSE PLIERS



Length: 150mm

Product code: 002371

DIAGONAL CUTTER



Cuts up to 2mm cable
Size: 175mm

Product code: 002366

VDE DIAGONAL CUTTERS



TUV/GS/VDE approved
Size: 175mm

Product code: 002372

VDE COMBINATION PLIER



TUV/GS/VDE approved
Size: 175mm

Product code: 002376

VDE WIRE STRIPPER



TUV/GS/VDE approved
Will strip cable up to 6mm diameter
Size: 150mm

Product code: 002375

VDE BENT NOSE PLIER



TUV/GS/VDE approved
Size: 200mm

Product code: 002374

VDE LONG NOSE PLIERS



TUV/GS/VDE approved
Size: 200mm

Product code: 002373

HAND TOOLS



HAND TOOLS

<p>WIRE STRIPPING PLIERS</p>	<p>CIRCLIP PLIERS</p>	<p>CARPENTERS PINCERS</p>
	 <p>EB - External bent ES - External straight IS - Internal straight</p>	 <p>Used to extract nails without cutting them Length: 180mm</p>
<p>Product code: 002338</p>	<p>Product code: EB: 180mm: 002335 ES: 180mm: 004880 IS: 180mm: 002336</p>	<p>Product code: 007535</p>
<p>FENCING PLIERS</p>	<p>BOLT CUTTERS</p>	<p>CURVED HEAD BOLT CUTTER</p>
 <p>Size: 250mm Nail extraction, nail driving, wire cutting, wire pulling, wire squeezing</p>	 <p>Sizes in stock:</p>	 <p>Size: 600mm Heavy duty</p>
<p>Product code: 002337</p>	<p>Product code: 450mm: 002356 600mm: 002357</p>	<p>Product code: 004314</p>
<p>BOLT CUTTER - CENTRE CUT</p>	<p>CRIMPING PLIER</p>	<p>STRAIGHT JAW LOCKING PLIERS</p>
 <p>Length: 200mm Capacity: soft 3.5mm, medium 2mm</p>	 <p>Stripping range: 0.75 - 6mm Length: 250mm</p>	 <p>Length: 178mm Capacity: 38mm</p>
<p>Product code: 008799</p>	<p>Product code: 002280</p>	<p>Product code: 002379</p>
<p>LOCKING PLIER WITH CURVED JAW</p>	<p>UTILITY SHEARS</p>	<p>GROOVE JOINT PLIER</p>
 <p>Length: 178mm Capacity: 38mm</p>	 <p>Size: 216mm</p>	 <p>Sizes in stock:</p>
<p>Product code: 002377</p>	<p>Product code: 002380</p>	<p>Product code: 250mm with 51mm capacity: 002367 300mm with 57mm capacity: 002368</p>

HAND TOOLS



HAND TOOLS

EXPERT PIPE WRENCH	Product code:	Length (mm)	Jaw (mm)
 <p>Deeply serrated and hardened jaws</p>	002381	355	60
	002382	450	70
	002383	600	85

STRAIGHT JAW PLIERS
 <p>Length: 400mm Capacity: 108mm Adjustments: 8</p>
Product code: 009394

PIPE WRENCH
 <p>Length: 175mm Jaw capacity: 42mm Screwdriver end on handle</p>
Product code: 002341

GORILLA BAR
 <p>Sizes in stock:</p>
Product code: 350mm: 002047 600mm: 002048 900mm: 002049

WIDE TIP GORILLA BONSAI BAR
 <p>Size: 250mm</p>
Product code: 002057

ROOFING GORILLA BAR & HAMMER
 <p>Size: 425mm</p>
Product code: 002046

ROOFING & DEMOLITION BAR
 <p>The side-by-side chisel ends can be rested on joists for added leverage when removing roof lathes, taking down ceilings and general demolition work</p>
Product code: 010052

HAND TOOLS



HAND TOOLS

DEMOLITION & LIFTING BAR



Ideal for lifting floorboards, removing ceiling boards, breaking pallets, removing roofing laths, lifting heavy objects and all types of demolition work

Product code: 010051

SLATER'S RIPPER



Product code: 002058

STRAIGHT RIPPING CHISEL



Size: 450mm

Product code: 002056

UTILITY BAR



Sizes in stock:

Product code: 175mm: 002053
380mm: 002054 450mm: 002055

DOUBLE ENDED NAIL PULLER



Size: 275mm

Product code: 002052

WRECKING BAR

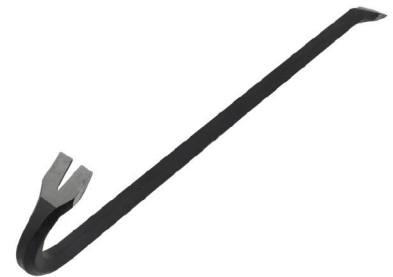

Size: 610mm

Product code: 002051

HAND TOOLS



HAND TOOLS

OX-PRO HANDY BAR



Size: 381mm

Product code: 001927

OX PRO CLAW BAR



Multi-functional claw bar for striking, prying & pulling
Sizes in stock:

Product code: 250mm: 001919
300mm: 001920

MINI HI-VIS WRECKING BAR



Length: 190mm
Colour may vary

Product code: 009516

STANDARD SEALANT GUN



Size: 425ml

Product code: 002595

PROFESSIONAL SEALANT GUN

**BEST
SELLER**



Size: 400ml

Product code: 002592

RESIN APPLICATOR



Size: 380ml

Product code: 002546

BRICK MORTAR GUN



Contains: Brick mortar gun
Scoop
Straight nozzle
Angle nozzle
Grouting nozzle

Product code: 002013

PROFESSIONAL FOAM GUN



Supplied complete with:
2 x long plastic extension tubes
2 x plastic nozzles

Product code: 002014

TILING STARTER KIT



Contents: 1 x Tile Marker
1 x Tile Scorer
1 x Tile File
1 x Combination Spreader/Squeegee
1 x Grout Finisher
100 x 1.5mm Tile Spacers

Product code: 002077

TILE SAW



Cutting depth: 150mm

Product code: 002076

TILE SAW BLADE



Size: 150mm

Product code: 002073

GROUT RAKE



Product code: 002074

HAND TOOLS



HAND TOOLS

<p>TILE NIPPER</p>	<p>TILE SCORER</p>	<p>HEAVY-DUTY TILE CUTTER</p>
		 <p>Fitted with a tungsten carbide wheel for scoring and snapping ceramic tiles up to 10mm thick</p>
<p>Product code: 002075</p>	<p>Product code: 002078</p>	<p>Product code: 002071</p>
<p>TILE ADHESIVE SCRAPER</p>	<p>REPLACEMENT BLADES</p>	<p>SURFORM® SHAVER TOOL</p>
 <p>Supplied complete with 100mm blade</p>	 <p>Replacement blades for the Tile Adhesive Scraper Pack of 5</p>	 <p>Blade size: 62mm</p>
<p>Product code: 002080</p>	<p>Product code: 002081</p>	<p>Product code: 002133</p>
<p>METAL BODY SURFORM® PLANE</p>	<p>SURFORM® BLADE STANDARD</p>	<p>SINGLE WHEEL GLASS CUTTER</p>
 <p>For use on all types of wood, aluminium, copper, plastic and laminates Blade size: 250mm</p>	 <p>Size: 250mm</p>	
<p>Product code: 002135</p>	<p>Product code: 002134</p>	<p>Product code: 002004</p>
<p>VOLTAGE TESTER</p>	<p>FATMAX® RATCHET SCREWDRIVER</p>	<p>FATMAX® RATCHET SCREWDRIVER STUBBY</p>
 <p>Blade size: 3 x 70mm Range: 150 - 240V</p>	 <p>45 tooth ratchet Supplied with a selection of 25mm screwdriving bits</p>	 <p>40 tooth ratchet In-built storage</p>
<p>Product code: 001760</p>	<p>Product code: 002116</p>	<p>Product code: 002115</p>

HAND TOOLS



HAND TOOLS

We Cut Keys!

TRADE SCREWDRIVER



Premium quality
Laser tips
Anti-rotate feature

Product code:	Drive	Blade length (mm)
009878	Slotted - 0.5 x 3	80
001773	Slotted - 0.8 x 5	100
009654	Slotted - 0.8 x 4	100
001782	Slotted - 1.2 x 6.5	150
001783	Slotted - 1.2 x 8	175
001784	Slotted - 1.6 x 10	200
001774	PH1	80
001775	PH2	100
001776	PH2	300
001777	PH3	150
001778	PZ1	80
001779	PZ2	100
001780	PZ2	300
001781	PZ3	150

TORX HEAD SCREWDRIVERS



Blade length: 100mm

Product code:	Torx drive
007333	10
007332	15
007331	20
007330	25
007299	30
007298	Set (all sizes listed)

FATMAX® STUBBY SCREWDRIVER



Size: 30mm

Product code:	Drive type
002117	PH1
002118	PH2
002119	PZ1
002120	PZ2

VDE SLIMLINE STUBBY SCREWDRIVER



Individually tested to 10,000V for safe working up to 1,000V

Product code:	Head type
007282	PZ2
007283	Slotted - 4
007284	Slotted - 5.5

VDE INSULATED SCREWDRIVER



Premium quality
Secure work at 1000V
Soft grip

Product code:	Drive	Blade length (mm)
001761	Slotted - 0.4 x 2.5	80
001762	Slotted - 0.6 x 3.5	100
001763	Slotted - 0.8 x 4	100
001764	Slotted - 1.0 x 5.5	125
001765	Slotted - 1.2 x 6.5	150
001766	Slotted - 1.2 x 8	175
001768	PH1	80
001769	PH2	100
001770	PZ1	80
001771	PZ2	100

VDE INSULATED SCREWDRIVER - SLIMLINE



Drive thickness: Slotted - 0.8mm
Blade length: 100mm
Reduced blade diameter

Product code: 001772

OFFSET SCREWDRIVERS



2 pack
Drives: slotted 5mm, PZ1 and PZ2
Length: 85mm

Product code: 007631

BASIC SCREWDRIVERS



Product code:	Drive	Length (mm)
009667	PZ1	75
009668	PZ2	100
009669	PZ3	150
009670	SL5	100



HAND TOOLS



TRADE SCREWDRIVER SET

Premium quality
Includes storage rack
6 pce



Product code: 001793

INSULATED SLIMLINE SCREWDRIVER SET

Premium quality
Safe work at 1000 volts
Includes rack and voltage tester



Product code: 001797

INSULATED SLIMLINE SCREWDRIVER SET

Premium quality
Safe work at 1000 volts
7 pce



Product code: 001794

INSULATED INTERCHANGEABLE SCREWDRIVER SET

Premium quality
18 pce
Includes voltage tester
89mm and 154mm length blades



Product code: 001785

INSULATED INTERCHANGEABLE SCREWDRIVER SET

Premium quality
17 pce
154mm long blades
Robust pouch



Product code: 001800

INSULATED INTERCHANGEABLE SCREWDRIVER SET

Premium quality
7 pce
154mm long blades
Robust pouch



Product code: 001796

TRADE INTERCHANGEABLE SCREWDRIVER SET

Premium quality
89mm long bits
Rapidaptor quick release chuck



Product code: 001801

TRADE INTERCHANGEABLE SCREWDRIVER

Premium quality
Complete with robust pouch, a 100mm hex adaptor and 6 x 25mm bits in popular drives



Product code: 001786

TRADE INTERCHANGEABLE SCREWDRIVER SET

Premium quality
89mm long blades
Robust pouch
17 pce



Product code: 001790

TOOL-CHECK PLUS SET

Premium quality



Product code: 001787

MICRO SCREWDRIVER SET

12 pce
Swivel cap for rapid twisting



Product code: 001806

MICRO SCREWDRIVER SET

6 pce
Swivel cap for rapid twisting



Product code: 001807

HAND TOOLS



HAND TOOLS

PRECISION SCREWDRIVER SET

Contents: Screwdriver handle, double ended blades, PH000, PH00, PH0, PH1, TX05, TX06, TX07 and TX08



Product code: 002360

OX PRO ADJUSTABLE WRENCH



Sizes in stock:

Product code: 150mm: 001847
200mm: 001848

OX PRO ADJUSTABLE WRENCH - EXTRA WIDE JAW



50mm wide opening jaw
Size: 250mm

Product code: 001951

COMBINATION SPANNER



Premium quality combination spanners

Product code:	Size (mm)
002194	6
002195	8
002196	10
002197	11
002198	12
002199	13
002200	14
002201	15
002202	17
002203	19
002204	21
002205	22
002206	24

COMBINATION SPANNER SET

12 pce

Sizes: 6 - 22mm

Chrome vanadium



Product code: 002528

LARGE ADJUSTABLE SPANNER



Length: 375mm
Capacity: 45mm

Product code: 004965

RATCHET COMBINATION SPANNER



180-degree head for access to tight spaces
72 tooth mechanism

Product code:	Size (mm)
002190	10
007266	13
002191	17

HEX KEY SET

Pouch included
Metric and imperial sizes

Short series
metric sizes: 1, 1.5, 2, 2.5, 3, 4, 4.5, 5, 5.5, 6, 7, 8 & 10mm

Long series AF sizes:
3/64, 1/16, 5/64, 3/32, 7/64, 1/8, 9/64, 5/32, 3/16, 7/32, 1/4 & 3/8 inch

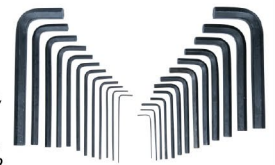

Product code: 007766

BUDGET HEX KEY SET



Metric sizes: 1.5 - 10mm

Product code: 008855

LONG ARM HEX KEY SET - IMPERIAL

Imperial sizes: 5/64, 3/32, 1/8, 5/32, 3/16, 7/32, 1/4, 5/16, & 3/8in AF



Product code: 007111



HAND TOOLS



LONG ARM HEX KEY SET - METRIC



Metric sizes: 1.3, 1.5, 2, 2.5, 3, 3.5, 4, 4.5, 5, 5.5, 6, 8 & 10mm

Product code: 002182

BALL ENDED LONG ARM HEX KEY SET - METRIC



Metric sizes: 1.3, 1.5, 2, 2.5, 3, 3.5, 4, 4.5, 5.5, 6, 8, 10mm

Product code: 002183

FOLDING HEXAGON KEY SET - METRIC



Metric sizes: 1.5, 2, 2.5, 3, 4, 5, 6 & 8mm

Product code: 002184

FOLDING BALL ENDED HEXAGON KEY SET - METRIC



Metric sizes: 1.5, 2, 2.5, 3, 4, 5, 6 & 8mm

Product code: 002185

HEX-PLUS MULTI-COLOUR ALLEN KEY SET



Premium quality
9 pce
Hexagonal ball point on long arm

Product code: 001791

HEX-PLUS ALLEN KEY SET



Premium quality
9 pce
Hexagonal ball point on long arm

Product code: 001792

TORX MULTI-COLOUR ALLEN KEY SET



9 pce
Ballpoint allows for offset working
Sizes: TX8 - TX40

Product code: 001805

T-HANDLE RATCHET SCREWDRIVER



Forward and reverse action
Magnetic 6.35mm drive
Includes assortment of bits
22 pce

Product code: 002499

SOCKET ADAPTORS



Premium quality adaptors

Product code:	Female (inches)	Males (inches)
002243	1/4"	3/8"
002256	3/8"	1/4"
002257	3/8"	1/2"
002212	1/2"	3/4"
002245	3/4"	1/2"

COUPLER ADAPTOR



1/4" drive
Length: 25mm

Product code: 002244

T BAR ADAPTOR



1/2" female to 3/8" male
Length: 40mm

Product code: 002211

UNIVERSAL JOINT DRIVES



Product code:	Female (inches)	Male (inches)
002255	3/8"	3/8"
002210	1/2"	1/2"

HAND TOOLS



HAND TOOLS

Bi-hexagon sockets



Premium 12 point sockets

Product code:	Drive (inches)	Socket size (mm)	Depth
002213	1/2	8	Standard
002214	1/2	9	Standard
002215	1/2	10	Standard
002235	1/2	10	Deep
002216	1/2	11	Standard
002217	1/2	12	Standard
002218	1/2	13	Standard
002236	1/2	13	Deep
002219	1/2	14	Standard
002220	1/2	15	Standard
002221	1/2	16	Standard
002222	1/2	17	Standard
002237	1/2	17	Deep
002223	1/2	18	Standard
002224	1/2	19	Standard
002238	1/2	19	Deep
002225	1/2	20	Standard
002226	1/2	21	Standard
002227	1/2	22	Standard
002228	1/2	23	Standard
002229	1/2	24	Standard
002239	1/2	24	Deep
002230	1/2	26	Standard
002231	1/2	27	Standard
002240	1/2	27	Deep
002232	1/2	28	Standard
002233	1/2	30	Standard
002234	1/2	32	Standard
002241	1/2	32	Deep
002246	3/4	33	Standard
002247	3/4	34	Standard
002248	3/4	36	Standard
002249	3/4	38	Standard
002250	3/4	41	Standard
002251	3/4	46	Standard
002252	3/4	50	Standard

EXTENSION BARS



Premium quality extension bars

Product code:	Drive (inches)	Length (mm)
002253	3/8"	150mm
002254	3/8"	250mm
002209	1/2"	150mm
002208	1/2"	250mm

DEEP SOCKET RAIL



Drive: 3/8
Sizes: 10, 12, 13, 14, 15, 17 and 19mm

Product code: 002258

HEX SOCKET RAIL



Drive: 3/8
Hex sizes: 3, 4.5, 5.5, 6, 7, 8, 10 and 12mm

Product code: 002259

TORX SOCKET RAIL



1/4 drive sizes: E4, E5, E6, E7 and E8
3/8 drive sizes: E10, E12, E14, E16 and E18

Product code: 002261

EXTERNAL TORX RAIL SET

Drive: 3/8

Sizes in rail: TX10, TX15, TX20, TX25, TX27, TX30, TX40, T45 and TX50



Product code: 002260

DEEP SOCKET RAIL



Drive: 1/2 drive
Sizes: 13, 14, 15, 17, 19, 21, 22 and 24mm

Product code: 002242

HAND TOOLS



BOX SPANNER SET



Contents: 8, 9, 10, 11, 12, 13, 14, 15, 17, 19, 21 & 22mm + 14mm spark plug spanner

Product code: 002513

RATCHETS



PREMIUM UNIOR RATCHETS



TORQUE WRENCH



1/2" drive
Range: 40 - 200 Nm
Length: 465mm
Manufactured to DIN 3122

Product code: 002193

Product code:	Drive	Number of teeth
002188	1/4	72
002189	3/8	72
002187	1/2	72

Product code:	Drive	Number of teeth
002172	1/4	40
002173	3/8	75
002171	1/2	75

NUT SPLITTER SET



Includes 2 - 15mm and 15 - 22mm

Product code: 002566

BAHCO SOCKET SET - 1/4 DRIVE



25 pce
Metric

Product code: 002260

BAHCO SOCKET SET - 1/2 DRIVE



24 pce
Metric

Product code: 009502

BAHCO SOCKET SET - 1/4 AND 3/8 DRIVE



25 pce
Metric

Product code: 009503

BAHCO SOCKET AND SPANNER SET - 1/4 AND 1/2 DRIVE



41 pce
Metric

Product code: 002242

BAHCO SOCKET AND SPANNER SET - 1/4 AND 1/2 DRIVE



94 pce
Metric and AF

Product code: 009505

HAND TOOLS



HAND TOOLS

We Cut Keys!

SCREW EXTRACTOR SET



Product code: 002262

SCREW EXTRACTORS



For extracting screws by hand or machine

Product code	Size (mm)
004340	3-5
004341	6
004342	8-10
004343	12
004344	14
004345	16-20

ADJUSTABLE TAP WRENCH



Tap sizes: 1 - 12mm

Product code: 004317

TAPS



For cutting thread by hand and machine
HSS-G

Product code:	Tap type	Size (mm)
004319	Taper	3
004320	Second	3
004321	Plug	3
004322	Taper	4
004323	Second	4
004324	Plug	4
004325	Taper	5
004326	Second	5
004327	Plug	5
004328	Taper	6
004329	Second	6
004330	Plug	6
004331	Taper	8
004332	Second	8
004333	Plug	8
004334	Taper	10
004335	Second	10
004336	Plug	10
004337	Taper	12
004338	Second	12
004339	Plug	12

HAND DRILL



Product code: 002084

RATCHETING TAP HOLDER



Product code:	Tap sizes (mm)
004315	3 - 10
004316	5 - 12

TAP, DIE AND DRILL SET

Contents:
Die stocks - 3,4,5,
6,8 and 10mm

Taps - 3, 4, 5,
6, 8 and 10mm

HSS Co drills - 2.5, 3.3,
4.2, 5.0, 6.9 and 8.5mm



Product code: 004318

TAP AND DIE SET



40 pce
Contains 16 metric taps and 16 metric dies

Product code: 002258

HALF ROUND CABINET RASP

Blade length: 250mm
Blade width: 25mm



Product code: 002317

HAND TOOLS



ROUND ENGINEERS FILE - SECOND CUT		
Product code:	Blade length (mm)	Blade width (mm)
002327	150	6
002328	200	8
002325	250	9
002326	300	10

FLAT ENGINEERS FILE - BASTARD CUT		
Product code:	Blade length (mm)	Blade width (mm)
002320	150	15
002318	250	24
002319	300	27

FLAT ENGINEERS FILE - SECOND CUT		
Product code:	Blade length (mm)	Blade width (mm)
002323	150	16
002324	200	20
002322	250	23

THREE SQUARE ENGINEERS FILE - SECOND CUT
 <p>Blade length: 150mm Blade width: 13mm</p>
Product code: 002329

HALF ROUND ENGINEERS FILE - SECOND CUT
 <p>Blade length: 200mm Blade width: 20mm</p>
Product code: 002321

CHAINSAW FILE
 <p>Cut: Single cut Blade length: 200mm Blades widths in stock:</p>
Product code: 4mm: 002315 5.5m: 002316

NEEDLE FILE SET
 <p>6 piece For use on metal and plastic Contents: Half round, round, flat taper, square, flat, three square</p>
Product code: 002339

A4 ASSORTMENT CASE
 <p>15 compartments</p>
Product code: 002266

A4 ASSORTMENT CASE
 <p>32 compartments</p>
Product code: 002267

HAND TOOLS



HAND TOOLS

A5 ASSORTMENT CASE



9 compartments

Product code: 002268

A6 ASSORTMENT CASE



7 compartments

Product code: 002265

EXPERT TOOLBOX



Size: 16 inch

Product code: 002264

FATMAX® DEEP PROFESSIONAL ORGANISER



10 removeable storage compartments

Product code: 002276

GALVANISED METAL TOOLBOX



Size: 23 inch
Dimensions: 662 x 293 x 222mm

Product code: 002084

STANLEY TOOLBOX



Sizes in stock:

Product code: 19 inch: 002272
24 inch: 002273

PROFESSIONAL MOBILE TOOL CHEST



Dimensions: 613 x 375 x 419mm

Product code: 002274

DEWALT 2.0 TOOLBOX



Depth: 309mm
Width: 554mm

Product code: 007356

VAN VAULT MOBI



Length: 780mm
Height: 380mm Depth: 415mm

Product code: 004387

VAN VAULT 2



Length: 940mm
Height: 490mm Depth: 530mm

Product code: 004386

VAN VAULT OUTBACK



Length: 1335mm
Height: 490mm Depth: 560mm

Product code: 002270

MULTI-ANGLE VICE



Size: 75mm

Product code: 002124

HAND TOOLS



HAND TOOLS

HEAVY-DUTY CORNER CLAMP



Size: 57mm

Product code: 002121

MAX-STEEL HEAVY-DUTY BENCH VICE



Size: 100mm

Product code: 002123

TURBOCLAMP ONE-HANDED SPEED CLAMP



Size: 150mm

Product code: 002015

CAST IRON G-CLAMP



Product code:	Size (mm)
002365	50
002570	75
009584	100
002571	150
002572	200

QUICK GRIP MINI BAR CLAMP - 150MM



Twin pack

Product code: 002358

IRWIN MEDIUM DUTY BAR CLAMP

BEST SELLER



Quick change
Size: 300mm

Product code: 008787

TREND MINI BAR CLAMP



Size: 152mm

Product code: 000171

TREND 'F' CLAMP



Sizes in stock:

Product code: 200mm: 000192
300mm: 000193

SPRING CLAMP



Size: 50mm

Product code: 002019

HEAVY DUTY HAND CLIP



Sizes in stock:

Product code: 50mm: 002016
75mm: 002017

NYLON RATCHETING CLAMP



Size: 235mm

Product code: 002018

HAND TOOLS



HAND TOOLS

<p>HEAVY DUTY F CLAMP</p>	<p>EXPERT SASH CRAMP</p>	<p>ADJUSTABLE HEIGHT DECORATORS PROP</p>
<p>Size: 1000 x 120mm</p> 	<p>Sold individually</p> <p>Sizes in stock:</p> 	<p>Size: 1.15 - 2.9m</p> <p>Max vertical weight capacity: 40Kg</p> 
<p>Product code: 002515</p>	<p>Product code: 1800mm: 002551 1500mm: 007946 1200mm: 002533</p>	<p>Product code: 002510</p>
<p>FOLDING SAW HORSE - TWIN PACK</p>	<p>JUNIOR STAPLE GUN</p>	<p>HEAVY DUTY STAPLE AND NAIL GUN</p>
 <p>Max load: 450kg per pair</p>	 <p>Type: JT21 Ideal for upholstery and general use</p>	<p>Type: T50</p> <p>Easy squeeze double leverage operation</p> <p>Suits T50 staples from 6mm to 14mm</p> <p>Suits 18G brad nails up to 15mm</p> 
<p>Product code: 007154</p>	<p>Product code: 002287</p>	<p>Product code: 002296</p>
<p>HAMMER TACKER</p>	<p>WALL ANCHOR SETTING TOOL</p>	<p>SINGLE RIVET TOOL</p>
 <p>Jam resistant mechanism, precision locked rear loading, and retractable striking edge Ideal for furniture fabrication and building insulation Will feed and drive two full strips of T50 staples (8 - 12mm)</p>	 <p>Length: 170mm For setting cavity wall fixings</p>	 <p>Changeable nose piece which can accommodate 1/8, 5/32 and 3/16 rivets</p>
<p>Product code: 002283</p>	<p>Product code: 002527</p>	<p>Product code: 002124</p>

HAND TOOLS



HAND TOOLS

PROFESSIONAL RIVET TOOL

Complete with four nose pieces to take 3/32, 1/8, 5/32 and 3/16 rivets



Product code: 002288

SWIVEL HEAD RIVET TOOL

Rotates through 360 degrees for riveting at any angle

Not suitable for stainless steel rivets

Supplied with nosepieces to suit 3/32, 1/8, 5/32 and 3/16 rivets



Product code: 002289

THREADED RIVET INSERT TOOL



Includes, 4, 5, 6 & 8mm threaded inserts, mandrel tools and handle clip

Product code: 002530

HEAVY DUTY LAZY TONGUE RIVETER

5 interchangeable nozzles

Rivet type accepted: Aluminium, steel, stainless steel

Rivet diameter: 2.4, 3.2, 4.0, 4.8 & 6.4mm



Product code: 009845

LIGHT DUTY STAPLES

To suit JT21 staple guns

Available in boxes of 1000

Sizes in stock:



**Product code: 6mm: 002284
8mm: 002286 10mm: 002285**

HEAVY DUTY STAPLES

For use with T50 and T55 tackers

Available in boxes of 1250

Sizes in stock:



**Product code: 6mm: 002292
8mm: 002294 10mm: 002293
12mm: 002291 14mm: 002295**

MULTI RIVET PACK

Contents:

- 25 - 1/8 Short aluminium rivets
- 20 - 1/8 Medium aluminium rivets
- 15 - 1/8 Long aluminium rivets
- 25 - 1/8 Short steel rivets
- 20 - 1/8 Medium steel rivets
- 15 - 1/8 Long steel rivets



Product code: 002290

RADIATOR KEY



Twinpack

Product code: 002278

IMMERSION HEATER SPANNER - CRANKED



Product code: 002333

MANHOLE KEYS



Size: 125mm
Twinpack

Product code: 002350

MANHOLE KEYS



Sold individually
Sizes in stock:

**Product code: 170mm: 004699
320mm: 004698**

PLASTIC PIPE CUTTER



Capacity: 42mm

Product code: 007764

HAND TOOLS



HAND TOOLS

We Cut Keys!

<p>AUTOMATIC COPPER PIPE CUTTER</p>	<p>ADJUSTABLE BASIN WRENCH</p>	<p>LIGHTWEIGHT SOLDERING IRON</p>
<p>Sizes in stock:</p> 	 <p>Supplied with small (15mm) and medium (22mm) jaws</p>	 <p>Complete with metal holder Fitted with 13a plug and 32mm tip 230/240V</p>
<p>Product code: 15mm: 002351 22mm: 002352</p>	<p>Product code: 002353</p>	<p>Product code: 002342</p>
<p>SOLDER REEL</p>	<p>SOLDERING IRON STAND</p>	<p>SOLDER DISPENSER</p>
<p>Size 12 reel Diameter: 1.22mm Self fluxing multi-core solder Five cores of Ersin flux for instant wetting of joints</p> 	 <p>Size: 85 x 125mm base</p>	<p>Savbit multi-core alloy solder reduces copper erosion Size 5 dispenser Diameter: 1.2mm</p> 
<p>Product code: 002354</p>	<p>Product code: 002502</p>	<p>Product code: 002355</p>
<p>SLATE AND TILE CUTTER</p>	<p>SINGLE STEP BY-PASS PRUNER</p>	<p>SMARTFIT BYPASS PRUNER</p>
<p>Contains a slate hole punch Approx length: 300mm Replaceable blade and punch Punch diameter: 3.2mm Cutting Length: 35mm per single pressure Cutting width: 2.8mm</p> 	<p>Cutting capacity: 22mm Length: 208mm Weight: 200g</p> 	<p>Adjustable cutting aperture Cutting capacity: 24mm Length: 208mm Weight: 192g</p> 
<p>Product code: 002305</p>	<p>Product code: 003973</p>	<p>Product code: 002436</p>
<p>POWERGEAR X BY-PASS PRUNER</p>	<p>FIXED HANDLE HEDGE SHEARS</p>	<p>POWER GEAR HEDGE SHEARS</p>
<p>Cutting capacity: 26mm Optimised for medium and large hand sizes Blades manufactured from corrosion resistant steel Extremely lightweight</p> 	<p>Cutting capacity: 6mm</p> 	<p>Length: 570mm Weight: 630g</p> 
<p>Product code: 004978</p>	<p>Product code: 002434</p>	<p>Product code: 002440</p>

HAND TOOLS



TELESCOPIC BY-PASS LOPPERS

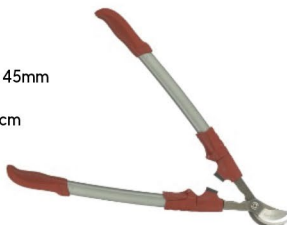

Cutting capacity: 45mm
Extends up to 95cm

Product code: 002441

POWERGEAR ANVIL LOPPERS



Extremely lightweight
Cutting capacity: 50mm
Overall length: 686mm
Weight: 1.1Kg

Product code: 002437

LONG HANDLED EDGING SHEARS



Length: 990mm
Weight: 1.69Kg

Product code: 002439

POWERGEAR BYPASS LOPPERS



Extremely lightweight
Cutting capacity: 50mm
Overall length: 692mm
Weight: 1060g

Product code: 002438

DISPOSABLE PAINT BRUSH SET



Size contents: 12, 25, 40, 50 and 75mm

Product code: 005784

ARTIST PAINT BRUSH SET



Size contents: 1 - 12mm
12 piece

Product code: 002491

BUDGET PAINT BRUSH RANGE



Product code:	Brush width (inches)
007008	1"
007009	1.5"
007010	2"
007011	3"
007013	4"

PREMIUM PAINT BRUSH RANGE



Product code:	Brush width (inches)
007003	1"
007004	1.5"
007005	2"
007006	3"
007446	4"

BUDGET PAINT BRUSH SET



Sizes: 3/4, 1, 1.5, 2 & 3 inch

Product code: 002333

PROFESSIONAL PUTTY KNIFE



Blade width: 38mm







Product code: 007026

HAND TOOLS



HAND TOOLS



SOFT GRIP PUTTY KNIFE	PROFESSIONAL FILLING KNIFE	PROFESSIONAL STRIPPING KNIFE																
 <p>Blade width: 38mm</p>																		
<p>Product code: 007037</p>	<table border="1"> <thead> <tr> <th>Product code:</th> <th>Blade width (mm)</th> </tr> </thead> <tbody> <tr> <td>007029</td> <td>25</td> </tr> <tr> <td>007027</td> <td>50</td> </tr> <tr> <td>007028</td> <td>100</td> </tr> </tbody> </table>	Product code:	Blade width (mm)	007029	25	007027	50	007028	100	<table border="1"> <thead> <tr> <th>Product code:</th> <th>Blade width (mm)</th> </tr> </thead> <tbody> <tr> <td>007023</td> <td>50</td> </tr> <tr> <td>007024</td> <td>64</td> </tr> <tr> <td>007025</td> <td>75</td> </tr> </tbody> </table>	Product code:	Blade width (mm)	007023	50	007024	64	007025	75
Product code:	Blade width (mm)																	
007029	25																	
007027	50																	
007028	100																	
Product code:	Blade width (mm)																	
007023	50																	
007024	64																	
007025	75																	
PROFESSIONAL CHISEL KNIFE																		
 <p>Blade width: 38mm</p>																		
<p>Product code: 002391</p>																		
PROFESSIONAL HEAVY DUTY WINDOW KNIFE	SOFT GRIP FILLING KNIFE	SOFT GRIP STRIPPING KNIFE																
 <p>Blade width: 32mm</p>																		
<p>Product code: 002390</p>	<table border="1"> <thead> <tr> <th>Product code:</th> <th>Blade width (mm)</th> </tr> </thead> <tbody> <tr> <td>007032</td> <td>25</td> </tr> <tr> <td>007033</td> <td>50</td> </tr> <tr> <td>007034</td> <td>75</td> </tr> </tbody> </table>	Product code:	Blade width (mm)	007032	25	007033	50	007034	75	<table border="1"> <thead> <tr> <th>Product code:</th> <th>Blade width (mm)</th> </tr> </thead> <tbody> <tr> <td>007035</td> <td>25</td> </tr> <tr> <td>007036</td> <td>50</td> </tr> <tr> <td>007042</td> <td>75</td> </tr> </tbody> </table>	Product code:	Blade width (mm)	007035	25	007036	50	007042	75
Product code:	Blade width (mm)																	
007032	25																	
007033	50																	
007034	75																	
Product code:	Blade width (mm)																	
007035	25																	
007036	50																	
007042	75																	
HEAVY DUTY LONG HANDLED SCRAPER																		
 <p>Blade width: 100mm Overall length: 300mm</p>																		
<p>Product code: 007038</p>																		

HAND TOOLS



SCRAPER BLADES



5 pack
To suit long handled scraper

Product code: 007039

ROLLER FRAME



Plastic handle
Head size: 9 x 1.3/4"

Product code: 007030

MINI ROLLER FRAME AND REFILLS

Length of frame: 250mm
Roller length: 100mm
Contains two medium pile rollers



Product code: 007019

MINI ROLLER REFILL PACKS



10 pack
Roller length 100mm

**Product code: Medium: 007018
Foam: 007040**

SHED AND FENCE BRUSH



Size: 120mm

Product code: 007016

BUDGET ROLLER KIT



Roller size: 9 inch
Contains two roller sleeves

Product code: 002491

STANDARD ROLLER REFILLS



Size: 9 x 1.3/4 inch

PLASTIC ROLLER TRAY



TRADE MICROFIBRE ROLLER KIT



Roller size: 9 inch
Contains one sleeve

Product code:	Pile type
007020	Short
007041	Medium
007022	Long

Product code	Size (mm)
007043	100
007001	230

RADIATOR ROLLER FRAME AND REFILLS



Roller size: 100mm
Contains 2 refills

Product code: 007021

HAND TOOLS



HAND TOOLS

MINI ROLLER KIT



Roller size: 100mm
Contains a foam roller and medium pile roller

Product code: 007031

PLASTIC PAINT KETTLE



Product code: 1.5L: 002501
2.5L: 002448

WINDOW SQUEEGEE



Size: 300mm

Product code: 002511

EXTENSION POLE



For use with paint rollers
Material: Aluminium
Size: 2m

Product code: 002391

DECORATORS SCISSORS



Size: 300mm
Stainless steel

Product code: 002541

WIRE BRUSH WITH SCRAPER - 4 ROWS



Suitable for metal, concrete, rust and paint

Product code: 004046

WIRE BRUSH - 4 ROWS



Product code: 004047 for use on stainless steel

Product code: 004045

DIPPED SCRATCH BRUSH



Product code: 004035

SCRATCH BRUSH - 3 PACK



Product code: 004036

MINI WIRE BRUSH SET



3 pce
Contains nylon, brass and stainless-steel bristles

Product code: 002021

WIRE BRUSH SET



3 pce
Contains nylon, brass and stainless-steel bristles

Product code: 002022

HAND TOOLS



HAND TOOLS

BLOCK WIRE BRUSH



Size: 165mm

Product code: 002026

SEALANT REPAIR KIT



Product code: 002030

SILICONE STRIP OUT AND SMOOTHING TOOL TWINPACK



Product code: 008991

REPLACEMENT PATIO BRUSH HEAD



Size: 133mm
To suit 002029 handle

Product code: 002028

METAL HANDLE

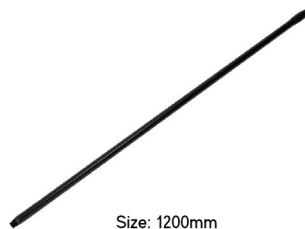

Size: 1200mm
To suit 002028 head

Product code: 002029

PROFILE GAUGE

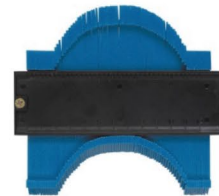

Length: 125mm
Max depth: 45mm

Product code: 002473

TELESCOPIC INSPECTION MIRROR



360 degree angle view
Extends from 200 – 500mm
30mm diameter mirror

Product code: 002470

MAGNETIC PICK UP TOOL



Extends 130 – 590mm
3.6Kg capacity

Product code: 002472

DEBURRING TOOL



For removing burr from steel, copper, brass and plastic pipes

Product code: 002483

SILICONE CARBIDE RUBBING BLOCK

Cleans concrete and plaster splashes, mould marks and high spots

20 grit

Size: 155 x 78 x 25mm



Product code: 007021

DOUBLE SUCTION PAD



Capacity: 100Kg

Product code: 002506

TYROLEAN GUN

Hand operated, rough-cast applicator of tyrolean and textured wall coatings

210mm comb diameter



Product code: 002490

HAND TOOLS



HAND TOOLS

**We Cut
Keys!**

BLOW OUT PUMP

For removal of dust
from drilled holes

Tube length: 280mm

Min hole diameter: 10mm



Product code: 002500

HEAVY DUTY GEAR PULLERS - 3 PCE

Sizes: 75, 100 &
150mm

For internal and
external use



Product code: 002563

ESTWING CURVED CLAW HAMMER

Red vinyl grip made from liquid vinyl that is bonded onto the shaft during production.

This offers the utmost in both comfort and durability, whilst reducing vibrations caused by impact.

The conventional carpenter's curved claw hammer offers unsurpassed balance and temper.

Made in the USA from high-quality steel

Weight: 560g (20oz)

Product code: 009944





LANDSCAPING TOOLS













Mitchells
Ironmongers

LANDSCAPING TOOLS



LANDSCAPING TOOLS















<p>STANDARD WHEELBARROW</p> <p>BEST SELLER</p> <p>Size: 85L Wheel type: Pneumatic Colour: Black</p> 	<p>STANDARD WHEELBARROW SOLID WHEEL</p> <p>Size: 85L Wheel type: Solid Colour: Galvanised</p> 	<p>TWIN WHEELBARROW</p> <p>Size: 90L Colour: Galvanised Wheel type: pneumatic</p> 
<p>Product code: 004295</p>	<p>Product code: 004297</p>	<p>Product code: 004293</p>
<p>PLUS WHEELBARROW</p> <p>Size: 85L Colour: Galvanised Wheel type: Solid Heavier duty tray than the standard wheelbarrow</p> 	<p>PLUS WHEELBARROW</p> <p>Size: 120L Galvanised Wheel types in stock:</p> 	<p>ULTIMATE WHEELBARROW</p> <p>Size: 120L Colour: Epoxy powder coated yellow Wheel type: Puncture free Specially designed for heavy loads</p> 
<p>Product code: 004296</p>	<p>Product code: Pneumatic: 004298 Puncture free: 004299</p>	<p>Product code: 004294</p>
<p>PNEUMATIC WHEEL FOR WHEELBARROW</p> <p>Load capacity: 150Kg Diameter: 350mm</p> 	<p>PUNCTURE-FREE WHEEL FOR WHEELBARROW</p> <p>Load capacity: 150Kg Diameter: 350mm</p> 	<p>WHEELBARROW INNER TUBE</p> <p>Size: 400ml</p> 
<p>Product code: 004305</p>	<p>Product code: 004304</p>	<p>Product code: 004303</p>
<p>TRADITIONAL SACK TRUCK</p> <p>Solid wheels Carrying capacity: 200Kg</p> 	<p>MULTI-USE SACK TRUCK</p> <p>Can be used as both a sack truck and a trolley Pneumatic wheels Carrying capacity: 250Kg</p> 	<p>LARGE TRADITIONAL SACK TRUCK</p> <p>Wheel type: Pneumatic Carrying capacity: 200Kg</p> 
<p>Product code: 004302</p>	<p>Product code: 009934</p>	<p>Product code: 004301</p>

LANDSCAPING TOOLS















LANDSCAPING TOOLS

<p>CONTRACTORS SPADE</p>	<p>BEST SELLER</p> 	<p>GARDEN SPADE</p>		<p>GARDEN SPADE - STAINLESS</p>	
<p>Handle size: 711mm Blade size: 7.5 x 11.5" Handles in stock:</p>		<p>Handle: 711mm Ash T Blade size: 7.5 x 11.5"</p>		<p>Handle: Ash YD Handle length: 711mm Blade dimensions: 7.5 x 11.5"</p>	
<p>Product code: Ash MYD: 003040 All steel MYD: 003041</p>		<p>Product code: 003028</p>		<p>Product code: 010097</p>	
<p>BORDER SPADE - STAINLESS STEEL</p>		<p>SOLID SOCKET SQUARE MOUTH SHOVEL</p>		<p>SOLID SOCKET TAPER MOUTH SHOVEL</p>	
<p>Handle: 711mm Ash T Blade size: 5.5 x 9"</p>		<p>Handle: 711mm Ash MYD Blade size: 10 x 12.5"</p>		<p>Handle: 711mm Ash MYD Blade size: 10" tapering to 9 x 13"</p>	
<p>Product code: 003037</p>		<p>Product code: 003008</p>		<p>Product code: 003009</p>	
<p>SOLID SOCKET TAPER MOUTH SHOVEL - ALL STEEL</p>		<p>OPEN SOCKET SHOVEL</p>		<p>SOLID SOCKET ROUND MOUTH SHOVEL</p>	
<p>Handle: 711mm All steel Blade size: 10" tapering to 8.5 x 12.5"</p>		<p>For lightweight general-purpose work Handle: 711mm Ash T Blade sizes in stock:</p>		<p>Used for shovelling most aggregates Handle: 711mm Ash MYD Blade size: 10 x 12.5"</p>	
<p>Product code: 003010</p>		<p>Product code: 10 x 12.5": 002985 13 x 15.1": 002990</p>		<p>Product code: 003007</p>	
<p>NEWCASTLE DRAINER</p>		<p>CLAY GRAFTING SHOVEL</p>		<p>CABLE LAYING SHOVEL</p>	
<p>Handle size: 711mm Blade size: Tapered to 4 x 16" Handles in stock:</p>		<p>Handle size: 711mm Blade size: 6 x 12" Handles in stock:</p>		<p>Handle size: 711mm Blade size: 5.5" tapering to 4.5 x 11" Handles in stock:</p>	
<p>Product code: Ash MYD: 002998 All steel: 002999 Insulated: 003001</p>		<p>Product code: Ash MYD: 003017 All steel: 003018</p>		<p>Product code: Ash MYD: 003019 All steel: 003020 Insulated: 003021</p>	

LANDSCAPING TOOLS















LANDSCAPING TOOLS

<p>TAPER MOUTH INSULATED SHOVEL</p>		<p>POLYPROPYLENE SHOVEL</p>		<p>POLYPROPYLENE SNOW BURNER</p>	
<p>Tested to BS 8020:2011 Handle: 711mm insulated Blade size: 10" tapering to 8.5 x 12.5"</p>		<p>Handle: 711mm Blade size: 10 x 12.5"</p>		<p>Handle: 711mm polypropylene Blade size: 13.5 x 16"</p>	
<p>Product code: 003011</p>		<p>Product code: 003006</p>		<p>Product code: 003014</p>	
<p>CONTRACTORS FORK - ALL STEEL</p>		<p>GARDEN FORK - STAINLESS</p>		<p>GARDEN FORK</p>	
<p>Handle: 711mm all steel MYD Blade size: 8 x 12"</p>		<p>Handle: Ash YD Handle length: 711mm Blade dimensions: 7.5 x 11.5"</p>		<p>Handle: 711mm Ash T Blade size: 7.5 x 11.5"</p>	
<p>Product code: 003031</p>		<p>Product code: 010096</p>		<p>Product code: 003027</p>	
<p>BORDER FORK - STAINLESS STEEL</p>		<p>MICRO SHOVEL SQUARE POINT HANDLE</p>		<p>MICRO SHOVEL ROUND HANDLE</p>	
<p>Handle: 711mm Ash T Blade size: 5.5 x 9"</p>		<p>Size: 685mm</p>		<p>Size: 685mm</p>	
<p>Product code: 003036</p>		<p>Product code: 002070</p>		<p>Product code: 002069</p>	
<p>FORGED EDGING KNIFE</p>		<p>DUTCH HOE</p>		<p>FORGED HAND TROWEL</p>	
<p>Handle: 914mm extended Ash T Blade size: 203mm</p>		<p>Handle: 1370mm Ash Blade size: 127mm</p>		<p>Handle: 150mm Ash Blade size: 150mm</p>	
<p>Product code: 003025</p>		<p>Product code: 003024</p>		<p>Product code: 003030</p>	

LANDSCAPING TOOLS



LANDSCAPING TOOLS



<p>FORGED HAND FORK</p>		<p>LAWN RAKE - ASH HANDLE</p>		<p>LEAF RAKE</p>	
<p>Handle: 150mm Ash Blade size: 152mm</p>		<p>Handle: 54" hardwood Blade size: 18"</p>		<p>Handle: 1220mm hardwood Blade width: 610mm</p>	
<p>Product code: 003029</p>		<p>Product code: 003004</p>		<p>Product code: 003005</p>	
<p>GARDEN RAKE</p>		<p>TARMAC RAKE</p>		<p>ASPHALT RAKE</p>	
<p>Handle: 1372mm Ash Blade size: 457mm</p>		<p>Handle size: 1680mm Blade size: 16 x 4" Handles in stock:</p>		<p>Handle: 1680mm Blade size: 16 x 4" Handles in stock</p>	
<p>Product code: 002995</p>		<p>Product code: Hardwood: 003000 All steel: 003002</p>		<p>Product code: Hardwood: 002996 All steel: 002997</p>	
<p>ALUMINIUM LANDSCAPE RAKE</p>		<p>SQUARE RAMMER</p>		<p>DOCK SCRAPER</p>	
<p>Handle: 1800mm hardwood Blade width: 700mm</p>		<p>Handle length: 1220mm Weight: 6Kg Handles in stock:</p>		<p>Handle length: 1219mm hardwood Blade size: 5 x 9" Blade material: Carbon steel</p>	
<p>Product code: 003003</p>		<p>Product code: Ash: 002992 All steel: 002993</p>		<p>Product code: 002986</p>	
<p>SCRAPER - SOLID FORGED</p>		<p>SPRING STEEL SCRAPER</p>		<p>HEAVY FLOOR SCRAPER</p>	
<p>Handle: 1220mm hardwood Blade size: 7 x 15"</p>		<p>Handle: 1220mm hardwood Blade size: 8 x 3"</p>		<p>Handle: 1220mm tubular steel Blade size: 17 x 4.5"</p>	
<p>Product code: 003016</p>		<p>Product code: 003026</p>		<p>Product code: 003032</p>	

LANDSCAPING TOOLS



LANDSCAPING TOOLS













We Cut Keys!

<p>MUSHROOM DIGGING BAR</p>		<p>POST HOLE SPADE</p>		<p>HEEL & POINT CROWBAR</p>	
<p>Handle: 25mm carbon steel</p>		<p>Handle: 1450mm tubular steel Blade size: 5.5 x 12"</p>		<p>Diameter: 28mm Material: Steel with hardened tips Sizes in stock:</p>	
<p>Product code: 003033</p>		<p>Product code: 003035</p>		<p>Product code: 60": 003012 72": 003013</p>	
<p>SPAZZLE</p>		<p>RUBBER PAVIOURS MAUL</p>		<p>CAST FENCING MAUL</p>	
<p>Handle: 1500mm Blade size: 24 x 4" Types in stock:</p>		<p>Handle: 41" hickory Weight: 6.8Kg For tapping paving slabs whilst leaving them undamaged</p>		<p>Handle: 36" Hickory Size: 12lb Product weight: 6.5Kg</p>	
<p>Product code: Hardwood: 003042 Aluminium: 003015</p>		<p>Product code: 002991</p>		<p>Product code: 002994</p>	
<p>POST DRIVER</p>		<p>POST HOLE DIGGER</p>		<p>POST HOLE DIGGER</p>	
<p>Handle: 600mm all steel Diameter: 152mm</p>		<p>Blade depth: 350mm Shaft length: 1200mm Weight: 7kg</p>		<p>Handle: 1200mm hardwood Blades: 300 x 150mm Creates hole suitable for 125mm posts Weight: 3Kg</p>	
<p>Product code: 003034</p>		<p>Product code: 002549</p>		<p>Product code: 002560</p>	
<p>GRUBBING MATTOCK</p>		<p>PICK MATTOCK</p>		<p>NAVY PICK CHISEL AND POINT</p>	
<p>5lb cross chisel Size: 3 x 2" eye Weight: 2.3Kg</p>		<p>5lb chisel and point Size: 3 x 2" eye Weight: 2.3Kg</p>		<p>7lb chisel and point pick head Size: 3 x 2" eye Weight: 3.2Kg</p>	
<p>Product code: 002987</p>		<p>Product code: 002988</p>		<p>Product code: 002989</p>	

LANDSCAPING TOOLS



LANDSCAPING TOOLS

<p>SHOVEL HANDLES</p>		<p>SLEDGEHAMMER HANDLE</p>		<p>PICKAXE HANDLE</p>	
<p>711mm Ash T, bent taper: 002979 711mm Ash T, straight taper: 002980 711mm Ash YD, bent taper: 002981 711mm Ash YD, straight taper: 002982</p>		<p>Material: Hickory Size: 762mm</p>		<p>Hardwood Size: 915mm</p>	
<p>Product code: See above for codes</p>		<p>Product code: 002983</p>		<p>Product code: 002984</p>	
<p>CLUB HAMMER - FIBREGLASS HANDLE</p>		<p>CLUB HAMMER - HICKORY HANDLE</p>		<p>SLEDGEHAMMER - FIBREGLASS HANDLE</p>	
<p>Sizes in stock:</p>		<p>Sizes in stock:</p>		<p>Sizes in stock: 7lb - 003052 10lb - 003050 14lb - 003051</p>	
<p>Product code: 2.5lb: 003046 4lb: 003047</p>		<p>Product code: 2.5lb: 003048 4lb: 003049</p>		<p>Product code: See above for codes 7lb, 10lb, 14lb</p>	
<p>SLEDGEHAMMER - HICKORY HANDLE</p>		<p>SLEDGEHAMMER - FIBREGLASS HANDLE</p>		<p>FELLING AXE - FIBREGLASS HANDLE</p>	
<p>Sizes in stock: 7lb - 003055 10lb - 003053 14lb - 003054</p>		<p>Hammer weight: 8lb</p>		<p>Axe weight: 1.6Kg</p>	
<p>Product code: See above for codes 7lb, 10lb, 14lb</p>		<p>Product code: 002062</p>		<p>Product code: 002065</p>	
<p>SPLITTING MAUL - FIBREGLASS HANDLE</p>		<p>AXE - FIBREGLASS HANDLE</p>		<p>KINDLING SPLITTER</p>	
<p>Maul weight: 2.7Kg</p>		<p>Handle length: 370mm Axe weight: 600g</p>		<p>Splitter weight: 1.1Kg Handle length: 406mm</p>	
<p>Product code: 007774</p>		<p>Product code: 002064</p>		<p>Product code: 002066</p>	

LANDSCAPING TOOLS



LANDSCAPING TOOLS

WOOD GRENADE® SPLITTING WEDGE		MUTT MULTI-SCRAPER		BIG MUTT SCRAPER	
Weight: 1.82kg		Wooden handle: 940mm Blade: 100 x 200mm		Wooden handle: 1380mm Blade: 228 x 178mm	
Product code: 002059		Product code: 007772		Product code: 007773	

BROOM HANDLE		FLOOR SQUEEGEE		HAND BRUSH
Sold individually Sizes in stock:		Blade length: 620mm Handle length: 1500mm		
Product code: 1200mm: 002962 1500mm: 002963		Product code: 002975		Product code: Soft coco: 002964 Stiff bassine: 002965

SWEEPING BRUSHES			
			
Product code:	Head length (inches)	Bristle type	Handle length (mm)
002961	8"	Bassine	1200
002974	11"	Soft coco	1200
002973	12"	Soft coco	1500
002976	12"	Bassine	1500
002977	13"	Synthetic	1500
002969	18"	Soft coco	1500
002970	18"	Bassine	1500
002971	24"	Soft coco	1500
002972	24"	Bassine	1500
002959	36"	Soft coco	1500
002960	36"	Bassine	1500

BASSINE HAND SCRUB	
Size: 8 inch	
Product code: 002966	

2-STROKE SEMI SYNTHETIC OIL	
Volume: 100mm	
Product code: 002755	

LANDSCAPING TOOLS



LANDSCAPING TOOLS

<p>MINERAL CHAIN OIL</p>		<p>2-STROKE SEMI-SYNTHETIC OIL</p>	
<p>Reduces wear to extend the lifetime of the bar and chain Does not degrade with long-term indoor storage Suitable for temperatures as low as -20 degrees</p> <p>Sizes in stock:</p>		<p>Size: 1L</p> <p>Provides the highest level of performance at improving engine life Easily mixed with fuel, mixing ratio up to 1:50</p>	
<p>Product code: 5L: 002808 1L: 002810</p>		<p>Product code: 002809</p>	

ADVANCED-CUT CHAINSAW CHAIN

 <p>Low vibration, low kick-back</p>	<p>Product code:</p>	<p>Number of drive links</p>	<p>Gauge (inches)</p>	<p>Pitch (inches)</p>	<p>Bar length (inches)</p>
	006897	45	.043"	3/8"	12"
	002812	50	.043"	3/8"	14"
	002816	44	.050"	3/8"	12"
	002817	45	.050"	3/8"	12"
	002818	50	.050"	3/8"	14"
	002819	52	.050"	3/8"	14"
	002820	53	.050"	3/8"	14"
	002821	55	.050"	3/8"	16"
	002822	56	.050"	3/8"	16"
	002823	57	.050"	3/8"	16"

CHAINSAW MICRO CHISEL CHAIN

 <p>High performance chain with cutters that have small radius corners Easier and more forgiving than regular square cornered cutters Reduced kickback</p>	<p>Product code:</p>	<p>Number of drive links</p>	<p>Gauge (inches)</p>	<p>Pitch (inches)</p>
	002768	56	.058"	.325"
	002769	64	.058"	.325"
	002770	68	.058"	.325"
	002771	72	.058"	.325"
	002772	56	.063"	.325"
	002773	62	.063"	.325"
	002774	68	.063"	.325"

LANDSCAPING TOOLS



LANDSCAPING TOOLS

SPEEDCUT CHAINSAW CHAIN



High performance chain designed for the professional
High efficiency, speed and performance
Suitable for Micro-lite guide only

Product code:	Number of drive links	Gauge (inches)	Pitch (inches)	Bar length (inches)
002824	64	.050"	.325"	15"
002825	72	.050"	.325"	18"

POWERSHARP CHAINSAW CHAIN



Designed for use with the powersharp system

Product code:	Number of drive links	Gauge (inches)	Pitch (inches)	Bar length (inches)
002834	50	.050"	3/8"	14"
002835	52	.050"	3/8"	14"

SINGLE RIVET CHAINSAW GUIDE BAR



Product code:	Bar length (inches)	Gauge (inches)	Drive links	Pitch (inches)
002761	14"	.050"	52	3/8"
002762	14"	.050"	50	3/8"
002766	16"	.050"	56	3/8"

PRO-LITE GUIDE BAR



Product code:	Bar length (inches)	Gauge (inches)	Drive links	Tail mount	Pitch (inches)
002763	15"	.050"	64	K095	.325"
002764	15"	.058"	64	K095	.325"
002765	15"	.058"	56	D009	3/8"
002767	16"	.050"	56	A041	3/8"

GUIDE BAR COVER



Sizes in stock:

Product code: 14": 002782
16": 002777 20": 002776

POWERSHARP BAR AND SHARPENER

Allows chainsaw user to sharpen blunted chains in a matter of seconds

Size: 14"

Guide types in stock:



Product code: A041: 002790
A074: 002791

POWERSHARP SHARPENER CLAMSHELL



Product code: 004303

LANDSCAPING TOOLS



LANDSCAPING TOOLS

FLAT CHAINSAW FILE



Length: 6"
Handle not included

Product code: 002760

FILE HANDLE



Product code: 002785

FILING KIT IN POUCH

Contents: assembled file holder, assembled wooden handle and flat file, depth gauge tool and a bar groove cleaner

Sizes in stock:



**Product code: 5/32: 002793
3/16: 002794 7/32: 002795**

ROUND CHAINSAW FILES



SURESHARP STONES

High quality shaping stones
For use on most electric chain sharpeners



Packs of 3

Sizes in stock:

**Product code: 3/16: 002779
5/32: 002780 7/32: 002781**

FILING VICE



Product code: 002775

Product code	Size (inches)	Pack size
002802	7/32"	1
002803	7/32"	3
002804	3/16"	1
002805	3/16"	3
002806	5/32"	1
002807	5/32"	3

SURESHARP 12V GRINDER



Complete with 5/32, 3/16 and 7/32 grinding stones

Product code: 002783

BRUSHCUTTER SQUARE LINE - NYLIUM

Rugged square profile for use on dry vegetation or rocky ground

Length: 40m
Width: 3mm



Product code: 002757

FLEXIBLADE LINE

Square profile for higher efficiency and aggression

Reduced fuel consumption

Designed for the jet-fit heads

Size: 4mm x 21m



Product code: 002833

YELLOW ROUNDLINE

Product code:	Line diameter (mm)	Length (m)
002826	1.3	15
002827	1.6	15
002828	2.0	15
002829	2.4	15
006545	2.4	90
002832	3.0	60

Round trimmer line



LANDSCAPING TOOLS



LANDSCAPING TOOLS

<p>UNIVERSAL TAP AND GO HEAD</p>	<p>TRIMMER HEAD - JETFIT 2 LINE</p>	<p>BRUSHCUTTER BLADE</p>	
<p>Suitable for all brush cutters and trimmers</p> <p>Diameter: 109mm</p> <p>Most suitable for motors between 25cc and 32cc</p> 	<p>For use with trimmers below 25cc</p> <p>Complete with flexiblade</p> 	<p>Complete with reducer ring to fit all brushcutters</p> <p>Size: 4mm</p> 	
<p>Product code: 002786</p>	<p>Product code: 002758</p>	<p>Product code: 002778</p>	
	<p>BRUSHCUTTER LINE - FLEXIBLADE PRE-CUT</p> <p>Width: 4mm Length: 26cm 20 lengths per tube</p> <p>Product code: 002759</p>		<p>PLASTIC FELLING WEDGE</p> <p>Sizes in stock 14cm - 002796 20cm - 002799</p> <p>Product code: see above</p>
	<p>STARTER ROPE</p> <p>Diameter: 4.5mm Sold in metre lengths</p> <p>Product code: 002784</p>		<p>CLEAR COMBI CAN</p> <p>Size: 5L of fuel and 3L of chain oil</p> <p>Product code: 002797</p>
	<p>CHAINSAW SAFETY HELMET</p> <p>Product code: 002798</p>		<p>BRUSH CUTTER SAFETY KIT</p> <p>Contents: Protective earmuffs - 26dB (EN 352-1 certified) Medium working gloves - EN388 CAT II certified Safety glasses - 100% UV protection, EN 166 certified</p> <p>Product code: 002800</p>
	<p>CHAINSAW SAFETY KIT</p> <p>Contents: Universal chainsaw safety leggings Safety helmet Chainsaw safety gloves</p> <p>Product code: 002801</p>		<p>LEATHER/FABRIC WORK GLOVES</p> <p>Ideal for use with lawnmowers, brush cutters, grinders, and hedge trimmers</p> <p>Sizes in stock: M - 002788 L - 002787 XL - 002789</p> <p>Product code: see above</p>
	<p>CHAINSAW GLOVES</p> <p>Sizes in stock: M - 002814 L - 002813 XL - 002815</p> <p>Product code: see above</p>		<p>LOGGERS MATE</p> <p>Holds logs and timber from 50mm to 240mm diameter and up to 4m long Max timber weight: 150Kg</p> <p>Product code: 002607</p>



POWER TOOLS

Mitchells
Ironmongers

POWER TOOLS



POWER TOOLS

We Cut Keys!

All Bosch cordless tools available with 2 batteries, 1 battery, or naked your choice!

BOSCH PRO 12V TWINPACK

Contents:
combi drill and impact driver
2 x 2Ah batteries
Charger
Carry case



Product code: 000331

BOSCH PRO 18V COMBI DRILL

Contents:
Combi drill
2 x 5Ah batteries
Charger
Carry case



Product code: 000340

BOSCH PRO 18V TWINPACK

Contents:
Combi drill and impact driver
2 x 5Ah batteries
Charger
Carry case



Product code: 000334

BOSCH PRO 18V SDS HAMMER DRILL

Max in concrete: 18mm
Variable speed
Contents:
2 x 5Ah batteries
Charger
Carry case



Product code: 000335

BOSCH PRO 18V PLANER

Blade width: 82mm
Contents:
2 x 5Ah batteries
Charger
Carry case



Product code: 000337

BOSCH PRO 18V MULTI-TOOL

Variable speed
Complete with 16 accessories
Contents:
2 x 5Ah batteries
Charger
Carry case



Product code: 000338

POWER TOOLS

All Bosch cordless tools available with 2 batteries - 1 battery or naked your choice!



POWER TOOLS

BOSCH PRO 18V CIRCULAR SAW

Single speed
Depth of cut: 51mm
Complete with blade
Contents:
2 x 5Ah batteries
Charger
Carry case



Product code: 000339

BOSCH PRO 18V ANGLE GRINDER

Size: 115mm
Single speed
Side handle
Contents:
2 x 5Ah batteries
Charger
Carry case



Product code: 000333

BOSCH PRO RECIPROCATING SAW

1100 Watt
Depth of cut: 230mm
Variable speed
Carry case



Product code: 110V: 000332 240V: 000352

BOSCH PRO SDS HAMMER DRILL

**BEST
SELLER**

830 Watt
Max in concrete: 26mm
Variable/reversing
Carry case



Product code: 110V: 000343 240V: 000344

BOSCH PRO CIRCULAR SAW

1100 Watt
No load speed: 4900rpm
Depth of cut: 66mm
Size of blade: 165mm
Carry case



Product code: 110V: 000348 240V: 000349

BOSCH PRO JIGSAW

780 Watt
Variable speed
Tool free blade change
Carry case



Product code: 110V: 000358 240V: 000359

POWER TOOLS



POWER TOOLS

BOSCH PRO ANGLE GRINDER - 115MM

720 Watt
Single speed
Anti-restart function



Product code: 110V: 000361 240V: 000360

BOSCH PRO IMPACT DRILL

1100 Watt
2 speed/variable/reversing
Max in concrete: 20mm
Carry case



Product code: 110V: 000357

BOSCH PRO MULTI TOOL

300 Watt
Variable speed
Comes with 20 accessories
Complete with L-Boxx



Product code: 110V: 009576 240V: 009577

BOSCH PRO ANGLE GRINDER - 230MM

2200 Watt
Single speed
Plug not supplied with 110V version



Product code: 110V: 009942 240V: 009943

STIHL CHAINSAW - MS170

Entry level chainsaw
Bar length: 12"
Ideal for cutting firewood and general garden tasks



Product code: 000362

STIHL CHAINSAW - MS171

Bar length: 14"
Ideal for cutting firewood, general garden tasks and felling small trees



Product code: 000363

POWER TOOLS



POWER TOOLS

STIHL CHAINSAW - MS181 C-BE

Ergostart system

Bar length: 14"

Ideal for cutting firewood and felling trees up to 12 inches in diameter



Don't forget your chainsaw accessories on page 163

Product code: 000364

TREND T4 ROUTER

850W

1/4" Collet

Carry case



Product code: 115V: 000153 230V: 000152

TREND T5 ROUTER

1000W

1/4" Collet



Product code: 115V: 000151 230V: 000154

TREND T7 ROUTER

2100W

1/2" Collet



Product code: 230V: 006859

HENRY HOOVER

Ideal for cleaning hard surfaces



Product code: 110V: 000367 240V: 000368

TREND T32 CLASS M VACUUM

BEST SELLER

800W

20 litre capacity

5m power cable

3m hose

Professional Certified: Meets standard 2006/42/EC

Can purchase extra bags: 008555



Don't forget your filter bags on page 235

Product code: 110V: 00956 240V: 009563

POWER TOOLS



POWER TOOLS

CHICAGO PNEUMATIC AIR IMPACT WRENCH

Size: 1/2"
 One handed push button
 forward/reverse
 8400 rpm
 576 Nm of full power in reverse
 for removing the tightest nuts



Product code: 000369

FLEX PALM SANDER

220 Watt
 240V
 Cable length: 4m
 Base plate: 105 x 115mm



Product code: 000365

METABO RANDOM ORBITAL SANDER

240W
 240V
 Backing pad diameter: 125mm



Product code: 005285

STEPHILL SE2700 GENERATOR

Output: 27kVA/22kW
 Sockets: 1 x 16a 115V / 1 x 16a 230V
 Engine: Honda GX160
 Run time: 31 hours
 Weight: 34Kg



Product code: 000370

STEPHILL SE3400 GENERATOR

Output: 34kVA/27kW
 Sockets: 2 x 16a 115V / 1 x 16a 230V
 Engine: Honda GX200
 Run time: 25 hours
 Weight: 40 Kg



Product code: 000371

STEPHILL GE2500 GENERATOR

Output: 26kVA/21kW
 Sockets: 1 x 16a 115V / 1 x 16a 230V
 Engine: Honda GP 160
 Run time: 31 hours
 Weight: 34Kg



Product code: 000372



POWERTOOL ACCESSORIES

Mitchells
Ironmongers

POWERTOOL ACCESSORIES

We Cut Keys!

trend
routing technology

TREND STRAIGHT ROUTER CUTTERS



Trend two flute straight cutters

Suitable for a wide range of applications such as engraving, grooving, rebating and shallow mortising

Use on softwoods, hardwoods, MDF, plywood and chipboard

All cutters have a bottom cut feature

Product code:	Shank Dia (inches)	D (mm)	C (mm)	Overall length (mm)					
000040	1/4	12.7	19.1	59.5					
000043	1/4	12.7	25.4	66.0					
000042	1/2	12.7	25.4	68.0					
000041	1/4	12.55	25.4	66.0					
000046	1/4	12.7	31.8	72.5					
000045	1/2	12.7	31.8	74.5					
000044	1/2	12.7	38.0	81.0					
000049	1/4	14.3	19.1	60.0					
000047	1/4	14.0	19.0	59.5					
000048	1/2	14.0	50.0	95.5					
000054	1/4	14.3	25.4	68.5					
000051	1/4	15.0	25.0	65.5					
000050	1/2	15.0	25.0	67.5					
000052	1/2	15.0	35.0	76.5					
000053	1/2	15.0	50.0	89.0					
000060	1/4	15.9	19.1	59.5					
000056	1/4	16.0	19.0	60.0					
000055	1/2	16.0	19.0	61.0					
000057	1/2	15.9	32.0	74.0					
000058	1/2	16.0	51.0	89.5					
000059	1/2	15.9	63.0	105.0					
000062	1/4	15.9	25.4	75.5					
000061	1/2	15.9	25.4	60.0					
000063	1/4	17.5	19.1	60.0					
000067	1/4	17.5	25.4	65.0					
000065	1/4	18.0	25.0	65.0					
000064	1/2	18.0	25.0	67.0					
000066	1/2	18.25	19.1	60.0					
000068	1/4	19.1	19.1	59.5					
000073	1/4	19.1	25.4	66.0					
000072	1/2	19.1	25.4	64.0					
000069	1/4	20.0	20.0	60.5					
000070	1/2	19.1	50.0	92.5					
000071	1/2	20.0	25.0	66.5					
000075	1/4	20.6	19.1	59.0					
000074	1/4	21.0	19.0	60.0					
000076	1/4	22.2	19.1	60.0					
000077	1/4	25.0	19.0	59.5					
000078	1/2	25.4	25.0	64.0					
000079	1/2	25.4	37.0	79.0					
000007	1/4	3.2	9.5	60.0					
000003	1/4	3.0	9.5	56.5					
000004	1/4	3.2	12.7	60.5					
000005	1/4	2.0	5.0	55.5					
000006	1/4	2.5	8.0	49.0					
000008	1/4	4.0	11.1	60.0					
000009	1/4	4.8	11.1	56.0					
000010	1/4	5.0	16.0	71.5					
000012	1/4	6.0	16.0	60.0					
000011	1/4	6.0	20.0	64.0					
000014	1/4	6.3	12.7	56.0					
000013	1/4	6.3	15.9	59.5					
000015	1/4	6.3	19.1	62.5					
000017	1/4	6.3	25.4	68.5					
000016	1/2	6.3	25.4	76.0					
000018	1/4	7.1	19.1	61.5					
000019	1/4	7.1	25.4	67.5					
000020	1/4	7.9	19.1	59.5					
000024	1/4	7.9	25.4	68.5					
000021	1/4	8.0	25.0	68.5					
000023	1/4	9.0	19.0	59.5					
000022	1/2	9.0	19.0	68.0					
000025	1/4	9.5	19.1	59.5					
000026	1/4	9.5	25.4	66.0					
000028	1/4	9.5	31.8	72.5					
000027	1/2	9.5	31.8	76.5					
000033	1/4	10.0	19.1	59.5					
000032	1/2	10.0	19.1	63.0					
000029	1/2	10.0	35.0	79.0					
000031	1/4	10.0	25.0	58.0					
000030	1/2	10.0	25.0	69.0					
000034	1/4	11.1	19.1	59.5					
000036	1/4	11.1	25.4	66.0					
000035	1/4	11.1	32.0	72.5					
000039	1/4	12.0	19.1	60.0					
000038	1/2	12.0	19.1	61.5					
000037	1/4	12.0	19.0	71.0					
000137	1/2	12.0	63.0	100.0					

POWERTOOL ACCESSORIES



TREND SELF-GUIDED TRIMMERS

Used for trimming plastic or plywood overlays and copy profiling with a template

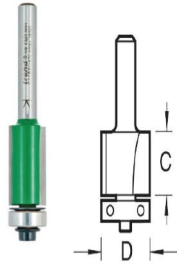

Product code:	Shank Dia (inches)	D (mm)	C (mm)	B (mm)	Overall length (mm)
000115	1/4	9.5	12.7	9.5	63.0
000114	1/4	9.5	24.5	9.5	75.0
000118	1/4	12.7	25.4	12.7	77.0
000117	1/2	12.7	25.4	12.7	79.5
000116	1/4	12.7	16.0	12.7	68.0
000122	1/4	15.9	15.9	15.9	67.5
000120	1/4	19.1	25.0	15.9	78.5
000119	1/2	19.1	25.0	15.9	76.5
000121	1/2	19.1	50.0	15.9	102.0

TREND TEMPLATE PROFILERS

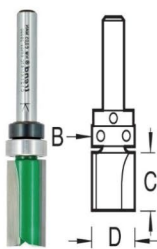

Product code:	Shank Dia (inches)	D (mm)	C (mm)	B (mm)	Overall length (mm)
000130	1/4	12.7	25.4	12.7	71.0
000126	1/4	12.7	9.5	12.7	55.5
000127	1/4	15.9	25.0	15.9	71.0
000128	1/4	12.7	32.0	12.7	77.5
000129	1/4	15.9	12.7	15.9	58.5
000131	1/4	19.1	25.4	19.1	65.5

POWERTOOL ACCESSORIES



POWERTOOL
ACCESSORIES

trend[®]
routing technology

TREND RADIUS CUTTERS

Ideal for engraving and decorative panel work

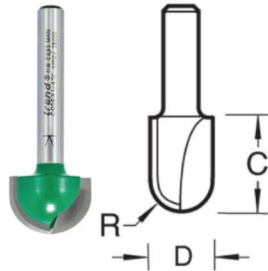

Product code:	Shank Dia (inches)	C (mm)	D (mm)	R (mm)	Overall length (mm)
000101	1/4	9.5	3.2	1.6	61.5
000102	1/4	12.7	6.3	3.2	65.0
000103	1/4	6.3	9.5	4.8	46.5
000104	1/4	7.9	12.7	6.3	48.5
000106	1/4	12.7	19.1	9.5	53.0
000105	1/2	32.0	19.1	9.5	80.0

TREND ROUNDING OVER CUTTERS

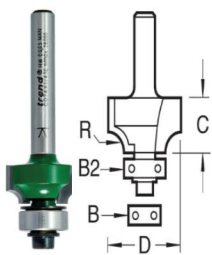

Product code	Shank Dia (inches)	D (mm)	C (mm)	B (mm)	B2 (mm)	R (mm)	Overall length (mm)
000107	1/4	19.0	9.5	9.5	12.7	3.2	61.0
000108	1/4	22.2	12.7	9.5	12.7	4.8	64.5
000109	1/4	25.4	12.7	9.5	12.7	6.3	64.0
000111	1/4	31.7	15.9	9.5	12.7	9.5	67.5
000110	1/2	31.7	15.9	9.5	12.7	9.5	66.0
000113	1/4	38.0	19.1	9.5	12.7	12.7	70.5
000112	1/2	38.0	19.1	9.5	12.7	12.7	68.5

POWERTOOL ACCESSORIES



POWERTOOL
ACCESSORIES

TREND ROMAN OGEE RADIUS CUTTER

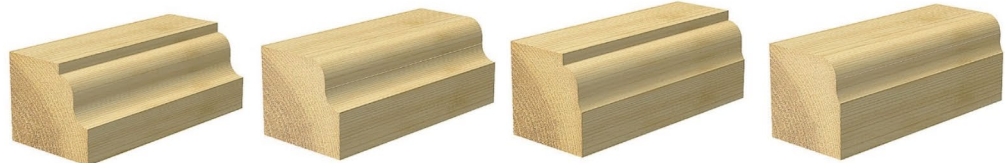
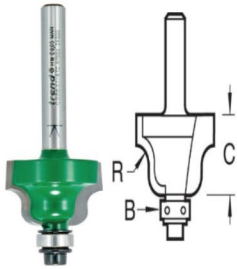

Product code:	Shank Dia (inches)	D (mm)	C (mm)	B (mm)	R (mm)	Overall length (mm)
000001	1/4	25.4	15.9	9.5	4.0	65.5

TREND SELF-GUIDED REBATERS

These cutters are self-guiding and can be used to produce rebates, lap joints, tongues and rebated corners

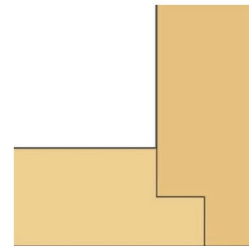
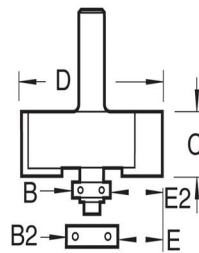

Product code:	Shank Dia (inches)	D (mm)	C (mm)	B (mm)	B2 (mm)	E (mm)	E2 (mm)	Overall length (mm)
000081	1/4	35.0	12.7	9.5	12.7	11.1	12.7	65.0
000080	1/2	35.0	12.7	9.5	12.7	11.1	12.7	63.0

TREND CHAMFER ANGLE CUTTERS

For producing extra clean-cut beveled edges

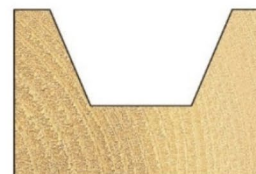

Product code:	Shank Dia (inches)	D (mm)	C (mm)	A (degrees)	Overall length (mm)
000095	1/4	22.2	10.0	67	50.0
000096	1/4	25.4	10.0	60	50.0
000097	1/4	34.9	10.0	45	50.0

POWERTOOL ACCESSORIES



POWERTOOL
ACCESSORIES



TREND CHAMFER V GROOVE CUTTER

For veining, panelling, 'V' grooving, bevelling & chamfering

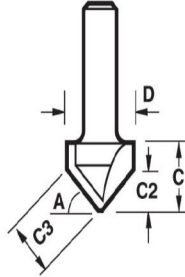

Product code	Shank dia (inches)	D (mm)	C (mm)	A (degrees)	Overall length (mm)
000086	1/4	12.7	11.0	60	53.0
000085	1/2	12.7	11.0	60	55.0
000082	1/4	19.0	20.5	60	70.5
000090	1/4	12.7	13.0	45	53.0
000089	1/2	12.7	13.0	45	55.0
000087	1/2	19.1	11.0	45	54.5
000094	1/4	25.4	20.0	45	55.0
000091	1/2	32.0	23.0	45	55.0
000092	1/2	38.0	27.0	45	64.0
000093	1/2	51.0	33.0	45	71.0

TREND SELF-GUIDED CHAMFER ANGLE CUTTERS

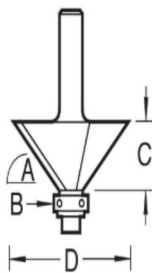

Product code	Shank Dia (inches)	D (mm)	C (mm)	B (mm)	Angle (degrees)	Overall length (mm)
000100	1/4	32.0	12.7	9.5	45	62.0
000099	1/2	32.0	12.7	9.5	45	60.0

TREND PIN GUIDED CHAMFER BEVEL CUTTER

For chamfering edges of plastic material
Shank size: 1/4"

Product code: 000098

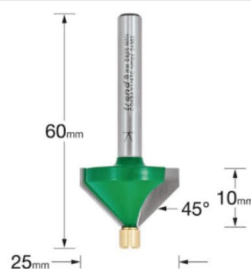

POWERTOOL ACCESSORIES



TREND SELF-GUIDED BEVEL TRIMMERS

Produces a smooth bevel finish for laminate and other materials

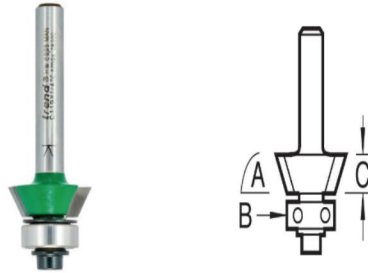

Product code:	Shank Dia (inches)	D (mm)	C (mm)	B (mm)	A (degrees)	Overall length (mm)
000124	1/4	18.5	6.3	12.7	65	58.0
000123	1/4	14.5	14.0	12.7	83	66.0

TREND KEYHOLE CUTTER

Plunge cutter & move forward, then retract out from entry hole

A template is recommended

For No8 & No10 screw heads

Not suitable for grooving applications

D - 9.5mm

D2 - 4.5mm

C - 4.5mm

S - 5.5mm

Shank diameter - 1/4"

Overall length: 53mm

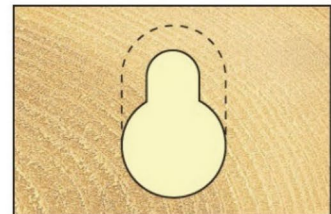
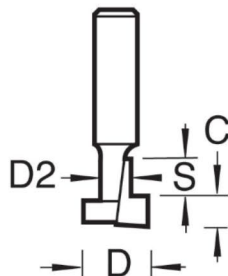

Product code: 000125

TREND TRIPLE FLUTE ENGRAVER

Shank size: 1/4"

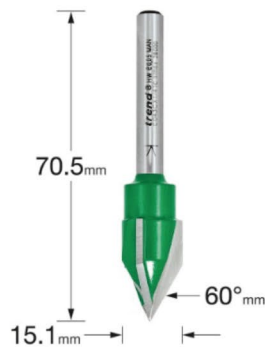

Product code: 000084

POWERTOOL ACCESSORIES



POWERTOOL
ACCESSORIES



TREND PANEL MOULD CUTTER

For veining, panelling, 'V' grooving,
bevelling & chamfering

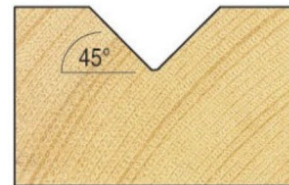
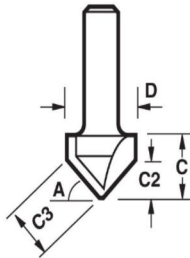

Product code:	Shank Dia (inches)	D (mm)	C (mm)	Bearing size (mm)	A (degrees)	Overall length (mm)
000083	1/4	12.7	12.7	12.7	45	52.5
000088	1/4	12.7	16.0	12.7	60	56.0

TREND BISCUIT JOINTER CUTTER SET

Supplied with 3 interchangeable
bearings to suit biscuit sizes, 0, 10 and 20

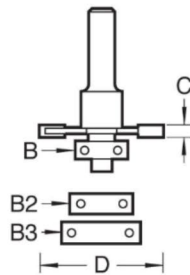

Product code:	Shank Dia (inches)	D (mm)	C (mm)	B (mm)	B2 (mm)	B3 (mm)	Overall length (mm)
000133	1/4	37.2	4.0	12.7	16.0	19.0	63.5
000132	1/2	37.2	4.0	12.7	16.0	19.0	64.0

TREND INTUMESCENT STRIP CUTTERS

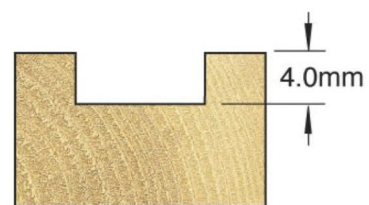
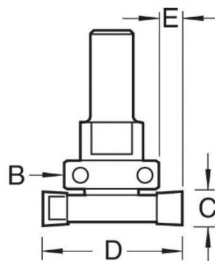

Product code:	Shank Dia (inches)	D (mm)	C (mm)	B (mm)	E (mm)	Overall length (mm)
000139	1/4	24.0	10.0	16.0	4.0	58.0
000138	1/2	40.0	10.0	32.0	4.0	62.0
000140	1/4	24.0	15.0	16.0	4.0	63.0
000141	1/2	40.0	15.0	32.0	4.0	67.0
000142	1/2	40.0	20.0	32.0	4.0	72.0

POWERTOOL ACCESSORIES

We Cut Keys!

trend[®]
routing technology

POWERTOOL
ACCESSORIES

TREND ROUTER MACHINE BIT

For recessing circular hinges
A template and guide bush fitted to the router base should be used
Shank dia: 1/2"



Product code: 000143

TREND HINGE SINKING CUTTER

For melamine faced boards

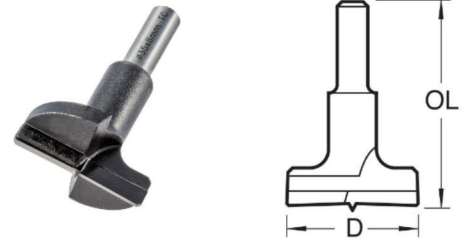

Product code:	Shank Dia (mm)	D (mm)	OL (mm)
000145	8.0	35.0	57.0

TREND ECONOMY WORKTOP CUTTER

BEST SELLER

Shank dia: 1/2"
Blade length: 50mm
Overall length: 90mm



Product code: 009507

TREND MEDIUM DUTY WORKTOP CUTTER

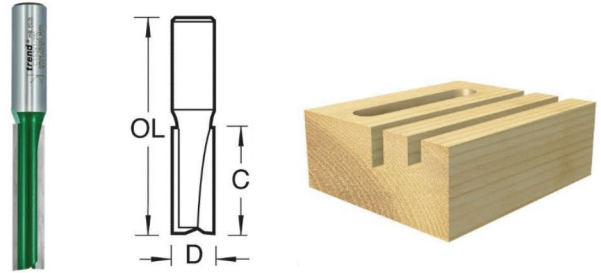

Product code	Shank Dia (inches)	D (mm)	C (mm)	OL (mm)
000135	1/2	12.7	50.0	93.5
000136	1/2	12.7	63.0	105

TREND WORKTOP CUTTER - 5 PACK

5-pack of medium duty worktop cutters (000135)



Product code: 000144

TREND PROFESSIONAL WORKTOP CUTTER

Shank Dia: 1/2"
Cutter diameter: 12.7mm
Cutter length: 50.0mm
Overall length: 99.0mm
Premium quality



Product code: 000327

POWERTOOL ACCESSORIES

POWERTOOL
ACCESSORIES



TREND PROFESSIONAL STRAIGHT CUTTER

000323 suitable for
Trend hinge and lock jigs

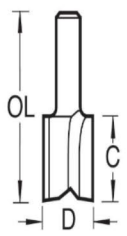

Product code:	Shank Dia (inches)	D (mm)	C (mm)	OL (mm)
000322	1/4	10.0	19.0	51.0
000321	1/2	10.0	19.0	63.0
000323	1/4	12.0	19.0	66.0

TREND PROFESSIONAL STRAIGHT CUTTER - ABRASIVE MATERIALS

Has a TCT plunge tip in the centre
For abrasive materials such as chipboard,
MDF, plywood, hardwoods and hard plastics

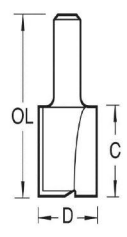

Product code:	Shank Dia (inches)	D (mm)	C (mm)	OL (mm)
000325	1/4	15.0	25.0	57.0
000324	1/2	15.0	25.0	57.0

TREND PROFESSIONAL ROTA-TIP CUTTER

Trend professional rota-tip cutter
Tool body can remain in place
while replacing blades - reducing
down time
Blade can be rotated 180 degrees
to double the lifetime of a
conventional blade
Suitable for plunge cutting
OL: 100.0mm
D: 12.7mm
C: 29.5mm

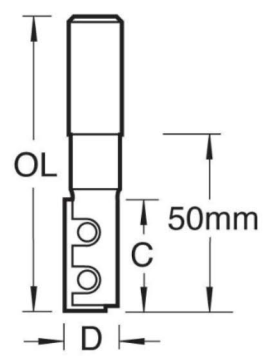

Product code: 000326

TREND PROFESSIONAL ROTA-TIP REPLACEMENT BLADES



Product code:	Length (mm)	Width (mm)	Thickness (mm)	Pack size
000210	29.5	9.0	1.5	1
000160	29.5	9.0	1.5	10
000156	49.5	9.0	1.5	1

POWERTOOL ACCESSORIES



POWERTOOL
ACCESSORIES

TREND ROUTER CUTTER SET - 15 PCE

1/2" shank
Contains a range of popular cutters



Product code: 000212

TREND ROUTER CUTTER SET - 12 PCE

1/4" shank
Contains a range of popular cutters



Product code: 000211

ABRACS CONTRACT DIAMOND BLADE

**BEST
SELLER**

Diameter: 300mm
Bore: 20mm



Product code: 007979

OX GENERAL-PURPOSE DIAMOND BLADE



Product code:	Diameter (mm)	Bore (mm)	Segment height (mm)
001821	115	22	10
001822	230	22	10
001823	300	20	10

OX TRADE GENERAL PURPOSE DIAMOND BLADE

General purpose blade
with all-round performance



Product code:	Diameter (mm)	Bore (mm)	Segment height (mm)
001818	115	22	12
001819	230	22	12
001820	300	20	12

OX TRADE ULTIMATE DIAMOND BLADE

Fast cutting universal blade
Features super-fast turbo segment
and cooling holes
Cuts it all - guaranteed



Product code:	Diameter (mm)	Bore (mm)	Segment height (mm)
001824	115	22	10
001825	230	22	10
001826	300	20	10

POWERTOOL ACCESSORIES



POWERTOOL
ACCESSORIES

OX STANDARD MORTAR RAKE DIAMOND BLADE

Entry level product for the cost-conscious user

Segment blade: 6mm

Diameter: 115mm

Bore: 22mm



Product code: 001817

OX TRADE MORTAR RAKE DIAMOND BLADE

Segment blade: 6mm

Diameter: 115mm

Bore: 22mm



Product code: 001832

OX DRY CORE DRILLS

Universal dry core for long life in most building materials including semi-engineering bricks, clay products, limestone and aggregate concrete



Product code:

Diameter (mm)

001810

38

001811

52

001812

65

001813

107

001814

117

001815

127

001816

152

FAITHFULL DIAMOND BLADE SET - 4 PCE

Contains 3 segmented blades and 1 continuous rim turbo blade

Blade size: 115mm

Bore: 22.2mm



Product code: 007618

SOLID EXTENSION

Thread: 1/2" BSP
Length: 250mm
A taper



Product code: 001829

POWERTOOL ACCESSORIES



TAPER DRILL	
<p>Diameter: 13mm Length: 210mm A taper</p>	
<p>Product code: 001828</p>	

SDS ADAPTOR	
<p>Thread: 1/2" BSP</p>	
<p>Product code: 001830</p>	

DRIFT KEY	
<p>1/2" shank</p>	
<p>Product code: 000212</p>	

HEX ADAPTOR	
<p>Thread: 1/2" BSP</p>	
<p>Product code: 001831</p>	

DIAMOND CORE SET	
<p>BEST SELLER</p> <p>Brand may vary 11-piece set Sizes included: 38, 52, 65, 117 and 127mm</p>	
<p>Product code: 007779</p>	

OX PRO DIAMOND DRILL BIT	
<p>Fast drilling long life diamond drills supplied with unique water container for accurate positioning and cooling of the diamond tip Standard hex shank</p> <p>Sizes in stock: 5mm - 001837 6mm - 001838 7mm - 001839 8mm - 001840 10mm - 001841 12mm - 001842 15mm - 001843 25mm - 001844</p>	
<p>Product code: see above</p>	

POWERTOOL ACCESSORIES

We Cut Keys!

POWERTOOL ACCESSORIES

OX PRO DRY DIAMOND DRILL BIT

Drills all tiles including porcelain
Fits almost any drill
Works without water

Sizes in stock:
6mm - 008346
7mm - 008347
8mm - 008348
10mm - 008349



Product code: see above

BOSCH CERAMIC DRILL BITS



For soft and medium density tiles

Product code	Diameter (mm)	Total length (mm)
000731	3	70
000732	5	70
000733	6	80
000734	7	80
008695	8	80
008694	10	90

BOSCH MASONRY DRILL BITS - SDS PLUS



4 flute design provides fast dust removal for increased drilling speeds and reduced wear

Effectively drills through steel reinforcement

Product code:	Diameter (mm)	Drilling length (mm)	Total length (mm)				
000510	4	50	115	000536	10	400	460
000507	5	100	160	000537	12	150	210
000549	5	150	210	000548	12	300	360
000523	5.5	100	160	000538	12	400	460
000550	5.5	150	210	000539	14	150	210
000558	6	100	160	000540	14	400	460
000530	6	150	210	000518	14	250	310
000553	6	200	260	000541	16	150	210
000520	6	400	465	000514	16	400	450
007489	6.5	100	160	000525	16	950	1005
000557	6.5	150	210	000508	18	150	200
000552	6.5	200	260	000542	18	250	300
000531	7	100	160	000543	20	150	200
000554	7	150	210	000544	20	400	450
000532	8	150	210	000511	22	200	250
000559	8	200	260	000560	22	550	600
000533	8	400	460	000561	24	200	250
000534	10	150	210	007474	26	200	250
000535	10	250	310	000545	26	400	450
000547	10	300	360				

POWERTOOL ACCESSORIES



ABRACS SDS PLUS DRILL BIT SET - 7 PCE

Bit length: 160mm
Contents: 5, 5.5, 6, 7, 8, 10 & 12mm



Product code: 007147

LONG SDS PLUS BIT SET

Contents:
12 x 1000mm
16 x 1000mm
24 x 1000mm



Product code: 008946

BOSCH MULTI-CONSTRUCTION DRILL BIT

Delivers stable drilling in all kinds of materials



Centring tip provides a steady drilling start and good guidance



Product code:	Diameter (mm)	Drilling length (mm)	Total length (mm)
000712	4	40	75
000713	5	50	85
000714	5.5	50	85
000715	6	60	100
000719	6.5	60	100
000720	6	90	150
000721	6.5	90	150
000725	7	90	150
000707	8	90	150
000708	10	90	150
000718	12	90	150
000709	6	200	250
000710	6.5	200	250
000711	7	200	250
000722	8	200	250
000723	10	200	250
000724	12	200	250
008824	14	150	200
008646	14	200	250

MULTI-CONSTRUCTION BIT SET - 7 PCE

Contents: 5, 5.5, 6, 6, 7, 8 & 10mm



Product code: 007416

MULTI-CONSTRUCTION BIT SET - 4 PCE

Contents: 5.5, 6, 7 & 8mm



Product code: 007420

POWERTOOL ACCESSORIES



POWERTOOL
ACCESSORIES

BOSCH MASONRY PERCUSSION DRILL BIT - STANDARD SHANK

2 flute U shape provides good dust removal

Standard carbide tip makes the drill bit more wear resistant



Product code:	Diameter (mm)	Drilling length (mm)	Total length (mm)
000500	5.5	90	150
000501	6.5	90	150
000502	7	90	150
000726	8	90	150

BOSCH WOOD-WORKING DRILL BIT SET

35 pce



Product code: 000499

BOSCH BRAD POINT DRILL BITS

Precise drilling into soft and hardwood



Product code:	Diameter (mm)	Drilling length (mm)	Total length (mm)
000492	3	33	61
000493	4	43	75
000494	5	52	86
000495	6	57	93
000496	7	69	109
000497	8	75	117
000498	10	80	120
008839	13	96	151

BOSCH AUGER DRILL BITS

Used for fast drilling accuracy in wood
Heavy duty self-feeding tip pulls the bit through completely, allowing for quick precision drilling



Product code:	Diameter (mm)	Drilling length (mm)	Total length (mm)
00665	10	160	235
00674	10	360	450
00666	12	160	235
00675	12	360	450
00668	16	160	235
00676	16	360	450
00669	20	160	235
00670	22	160	235
00671	24	160	235
00672	26	160	235
00673	32	160	235

POWERTOOL ACCESSORIES



LONG AUGER BIT SET

Bit length: 600mm
Sizes: 8, 12, 16 & 24mm

Product code: 002547

IRWIN STUBBY AUGER BIT SET

Total length: 100mm
Working length: 50mm

Contents: 16, 18, 20, 22, 25 & 32mm

Product code: 004438

BOSCH FLAT BITS

Extremely fast hole drilling in wood
Self-feeding threaded tip

Product code:	Diameter (mm)	Drilling length (mm)	Total length (mm)
000479	6	117	152
000480	8	117	152
000481	10	117	152
000482	12	117	152
000483	13	117	152
000484	16	117	152
000485	20	117	152
000486	22	117	152
000487	25	117	152
000489	28	117	152
000490	32	117	152
000491	38	117	152

IRWIN STUBBY AUGER BITS

Total length: 100mm
Working length: 50mm

Product code	Diameter (mm)
004432	16
004433	18
004434	20
004435	22
004436	25
004437	32

BOSCH FLAT BIT SET

Contents: 13, 16, 19, 20, 22 & 25mm

Product code: 000478

POWERTOOL ACCESSORIES



POWERTOOL
ACCESSORIES

BAHCO FLAT BIT SET

**BEST
SELLER**

Contents:
13, 16, 18, 20, 22, 25, 32 and
38mm



Product code: 009501

MAKITA FORSTNER BITS

For producing clean cut flat
bottom holes, pocket holes and
through holes in wood

Centering point for accuracy



Product code

Hole diameter (mm)

004427

32

004428

35

004429

40

004430

50

BOSCH METAL DRILL BITS - HSS-CO

Provides long lasting performance when
drilling stainless steel

Cobalt alloy and fully ground HSS provide
wear resistance and heat protection



Product code	Diameter (mm)	Drilling length (mm)	Total length (mm)
000464	3	33	61
000465	4	43	75
000466	5	52	86
000467	6	57	93
000468	8	75	117
000469	10	87	133
000471	12	101	151

BOSCH BLACKSMITH DRILL BITS

Enables fast drilling into metal due to
Point-TeQ tip design

Self-centring tip prevents wandering,
making quick and easy drilling starts
possible



Product code	Diameter (mm)	Drilling length (mm)	Total length (mm)
008954	14	108	160
000475	16	120	178
000473	17	125	184
000474	18	130	191
000419	20	140	205

POWERTOOL ACCESSORIES



BOSCH METAL DRILL BITS - HSS-G	Product code	Diameter (mm)	Drilling length (mm)	Total length (mm)	Pack size
	000420	1	12	34	2
000421	1.5	18	40	2	
000422	2	24	49	2	
000463	2	24	49	10	
000423	2.5	30	57	2	
000447	2.5	30	57	10	
000424	3	33	61	2	
000448	3	33	61	10	
000455	3	66	100	1	
000425	3.3	36	65	2	
000426	3.5	39	70	2	
000449	3.5	39	70	10	
000456	3.5	73	112	1	
000427	4	43	75	2	
000450	4	43	75	10	
000457	4	78	119	1	
000428	4.2	43	75	1	
000429	4.5	47	80	1	
000430	5	52	86	1	
000451	5	52	86	10	
000458	5	87	132	1	
000431	5.5	57	93	1	
000432	6	57	93	1	
000452	6	57	93	10	
000459	6	91	139	1	
000433	6.5	63	101	1	
000434	6.8	69	109	1	
000435	7	69	109	1	
008264	7	69	109	10	
000436	7.5	69	109	1	
000437	8	75	117	1	
000453	8	75	117	5	
000460	8	109	165	1	
000438	8.5	75	117	1	
000439	9	81	125	1	
000440	9.5	81	125	1	
000461	10	121	184	1	
000441	10	87	133	1	
000454	10	87	133	5	
008794	10.2	87	133	1	
000442	10.5	87	133	1	
000443	11	94	142	1	
000444	12	101	151	1	
000445	12.5	101	151	1	
000446	13	101	151	1	



Solid drilling for standard usage with metal

Precision ground bit made of HSS enables fast results

No pilot hole or pre-punch required up to 10mm

POWERTOOL ACCESSORIES

We Cut Keys!

POWERTOOL ACCESSORIES

BOSCH DRILL BIT SETS

Ideal for drilling through metal



METABO HSS-R DRILL BIT SET - 25 PC

Contents: 1 - 13mm

For drilling through non-ferrous metals



Product code: 007644

Product code:	Drill bit type	Size range (mm)
009265	HSS	1 - 10
009872	HSS	1 - 13
009687	HSS - Co	1 - 10

BOSCH FORMWORK DRILL BIT

Long and versatile drill bits
Suitable for drilling wood and metal
Standard shank to suit 13mm chuck



Product code:	Drill bit diameter (mm)	Total length (mm)	Shank diameter (mm)
007415	6	600	5
000727	8	600	6
000728	10	600	8
000729	12	600	8
007924	16	600	10
007825	18	600	10
000730	20	600	10

COUNTERSINKS



Product code:	Countersink size (mm)	Shank dia (mm)	Shank length (mm)	Material
004441	13	6	40	Wood
004443	16	6	40	Wood
004442	13	6	20	Mild steel, plastics, non-ferrous metals

HSS COUNTERSINK SET



For steel and hard metals
Sizes included:
10, 12 & 16mm

Product code: 000529

POWERTOOL ACCESSORIES



STEP DRILLS

HSS material
For use in metal (up to 4mm thick)
Hole ranges in stock:



**Product code: 6-20mm: 004444
6-30mm: 004445**

STEP DRILL SET

Complete with storage case
For precision drilling of sheet metals, alloys and plastics up to 4mm thick



Product code: 009674

BOSCH POINTED CHISEL



SDS plus fitting
Length: 250mm

Product code: 000529

BOSCH FLAT CHISEL



SDS plus fitting
Length: 250mm

Product code: 000528

BOSCH SPADE CHISEL



SDS plus fitting
Blade width: 40mm
Length: 250mm

Product code: 000527

SDS PLUS CHISEL SET



Includes 20mm, 40mm and point chisel
Length: 250mm

Product code: 008642

IRWIN FLAT CHISEL

SDS max fitting
Chisel width: 25mm
Length: 280mm



Product code: 004439

IRWIN SPADE CHISEL

SDS max fitting
Blade width: 115mm
Length: 350mm

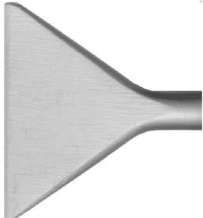

Product code: 007596

IRWIN SPADE CHISEL

SDS max fitting
Blade width: 80mm
Length: 300mm



Product code: 004440

IRWIN POINTED CHISEL

SDS max fitting
Length: 280mm



Product code: 004431

POWERTOOL ACCESSORIES



POWERTOOL
ACCESSORIES

BOSCH BI-METAL HOLE SAWS

Smooth cutting through various materials such as metal, PVC, wood and stainless steel

Threaded fitting



BOSCH PROGRESSOR BI-METAL HOLE SAWS



Smooth cutting through various materials such as metal, PVC, wood and stainless steel
Power-change fitting

Product code:	Diameter (mm)
000605	16
000606	20
000607	22
000608	25
000609	32
000610	38
000611	41
000612	44
000613	51
000614	57
000615	60
000616	64
000617	70
000628	73
000618	76
000619	79
000620	83
000649	86
000621	89
000623	95
000624	102
000625	114
000626	121
000627	152

Product code:	Diameter (mm)
000650	19
007436	20
000651	22
000631	25
000588	32
000652	38
000633	44
000653	51
000635	54
000636	57
000637	64
007437	73
000638	76
007438	79
000639	83
000640	89
000655	102
007439	127
000641	152

POWERTOOL ACCESSORIES



BOSCH HOLESAW ARBOUR					
	Product code:	Drill fitting	Holesaw fitting	Holesaw size range (mm)	Pilot drill length (mm)
	000661	Hex	Threaded	14 - 30	81
	000642	SDS plus	Power-change	16 - 210	85
	000659	Hex	Threaded	32 - 210	102
	007440	Hex	Power-change	16 - 210	85

BOSCH PILOT DRILLS FOR HOLESAWS				
	Product code	Drill bit material	Total length (mm)	Holesaw arbour type
	000643	HSS-G	80	Power-change
	000646	TCT	120	Power-change
	000645	HSS-Co	65	Power-change
	000644	HSS-Co	80	Power-change
	000647	HSS-Co	120	Power-change
	000658	HSS-G	81	Threaded
	000657	HSS-G	102	Threaded

BOSCH PROGRESSOR HOLESAW EXTENSION	
<p>8mm hex shank Length: 305mm</p>	
<p>Product code: 000584</p>	

BOSCH HOLE SAW SET	
<p>Standard screw-on change</p> <p>Contents: 20, 25, 32, 38, 51, 64mm</p> <p>2 x hex socket adaptors</p> <p>1 x Allen key</p>	
<p>Product code: 009369</p>	

POWERTOOL ACCESSORIES



POWERTOOL
ACCESSORIES

BOSCH RECIPROCATING SAW BLADES

	Product code:	Total length (mm)	TPI	Material	Pack size
	007432	150	8-14	Sheet metal (1 - 8mm)	5
	007434	150	18	Sheet metal (1.5 - 4mm)	5
	000583	225	18	Sheet metal (1.5 - 4mm)	5
	007433	150	14	Sheet metal (3 - 8mm)	5
	000582	225	14	Sheet metal (3 - 8mm)	5
	007435	150	3	Wood without nails (up to 100mm)	5
	007419	225	3	Wood without nails (up to 175mm)	5
	007422	150	10-14	Wood with nails (up to 100mm) Metal profiles (3 - 10mm)	5
	007421	240	5	Pruning green wood/firewood	5
	007423	150	6	Chipboard/MDF (6 - 60mm)	5
	000581	150	10	Wood with nails (up to 100mm) Metal profiles (3 - 12mm)	5
	000577	200	6-12	Wood with nails (up to 150mm) Sheet metals (3 - 18mm)	2
	007424	200	6-12	Wood with nails (up to 150mm) Sheet metals (3 - 18mm)	5
	007425	200	2	Brick/block (up to 150mm)	1

Possess a 1/2" shank and so are compatible with most reciprocating saw brands

POWERTOOL ACCESSORIES



BOSCH RECIPROCATING SAW BLADE SET - 2 PCE		
Total length (mm)	TPI	Material
200mm	6-10	Wood
240mm	5	Wood (up to 190mm)

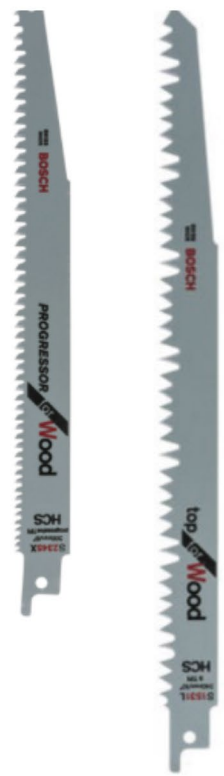

BROACH CUTTERS	
For use with mag drills Total cutter length: 60mm (short)	
Product code:	Hole diameter (mm)
004422	12
004423	14
004424	16
008811	18
008497	22

BOSCH RECIPROCATING SAW BLADE SET - 20 PCE	
Contents: An array and reciprocating saw blades suitable for both wood and metal cutting Max total blade length: 150mm	
Product code: 009369	

BROACH CUTTER PILOT DRILL	
Total length: 78mm	
Product code: 004425	

POWERTOOL ACCESSORIES

We Cut Keys!

POWERTOOL
ACCESSORIES

FREUD CIRCULAR SAW BLADES



Product code:	Blade diameter (mm)	Bore (mm)	Number of teeth	Material
000700	160	20	40	Wood
000688	165	20	24	Wood
000689	165	20	40	Wood
000693	180	30	24	Wood
000701	180	30	40	Wood
000702	184	16	40	Wood
000694	184	16	24	Wood
000690	190	30	12	Wood
000695	190	30	24	Wood
000703	190	30	40	Wood
000691	216	30	24	Wood
000696	216	30	48	Wood
000704	216	30	64	Wood
000697	230	30	34	Wood
000698	235	30	34	Wood
000692	250	30	24	Wood
000699	250	30	40	Wood
000705	250	30	60	Wood
000687	260	30	60	Wood
000706	190	30	38	Wood, mild steel (up to 3mm), plastic, aluminium, laminates, plexiglass

POWERTOOL ACCESSORIES

POWERTOOL
ACCESSORIES

BOSCH JIGSAW BLADES				
Product code:	Total length (mm)	Material	Cut	Pack size
000569	83	Softwood, plywood and laminated panels (1.5-15mm)	Curve cut/fast	5
000566	83	Softwood, plywood and laminated panels (1.5-15mm)	Curve cuts/clean	5
000568	92	Softwood (2-15mm), plywood, chipboards, wood core plywood and fibre boards	Straight cut	5
000565	100	Softwood, chipboard, wood core plywood, fibre boards (3-30mm) and plastics (up to 30mm)	Straight cut/fine	5
000564	100	Softwood, chipboard, wood core plywood, fibre boards (3-30mm), laminated and softwood panels (3-30mm), clean surface	Reverse tooth design for extra clean cut	5
000567	100	Softwood, plywood, chipboards, plywood and fibre boards	Straight cut/coarse	5
000578	100	Softwoods (5-50mm), wood core plywood, chipboard, fibre boards, doors and kitchen worktops (up to 50mm)	Straight cut/coarse	5
007426	117	Softwood (3-65mm), chipboards, wood core plywood and fibre boards	Straight cut/fine	5
007427	152	Softwood (5-100mm), chipboards, wood core plywood and fibre boards	Straight cut	5
007428	83	Laminates (1.5-15mm)	Curved cut/clean	3
000579	100	Hardwood, laminated boards, HPL (2-30mm), plastics (up to 30mm)	Straight cut	5
007429	117	Hardwood panels and kitchen worktops (up to 50mm)	Curved cut/clean	3
007430	132	Wood with nails (up to 65mm), plastic, sheet metals (3-10mm), pipes, profiles	Straight cut/coarse	5
000571	92	Very thin sheet metal (1/64 - 3/64" thick)	Straight cut/fast	5
000580	92	Sheet metals (1-3mm)	Straight cut	3
000572	92	Sheet metals (1-3mm)	Straight cut	5
000573	92	Sheet metals (2.5-6mm)	Straight cut	5
000575	132	Sheet metal (2.5-6mm)	Straight cut/fine	5
000574	92	Sheets metals (1-3mm)	Curve cut/fine	5
007431	83	Inox/stainless steel (0.5-1.5mm)	Straight cut	3
000570	83	Inox/stainless steel (1.5-3mm)	Straight cut	3



POWERTOOL ACCESSORIES

POWERTOOL
ACCESSORIES

BOSCH CIRCULAR SAW BLADES - TWIN PACKS



Product code:	Blade diameter (mm)	Bore (mm)	Number of teeth on each blade	Material
009547	190	30	12 & 48	Wood
000686	216	30	48 & 80	Wood
000683	254	30	24 & 80	Wood
000684	260	30	48 & 80	Wood
000685	305	30	60 & 80	Wood

TREND CIRCULAR SAW BLADES



Product code:	Blade diameter (mm)	Bore (mm)	Number of teeth	Kerf (mm)	Material
000317	120	20	24	1.8	Wood
000302	136	20	12	1.5	Wood
000303	136	20	24	1.5	Wood
000318	160	20	24	2.2	Wood
000179	160	20	36	2.2	Wood
000305	160	20	48	2.4	Wood
000312	160	20 (16mm reducer)	52	2.2	Aluminium and plastic
000306	165	20	24	1.5	Wood
000307	165	20	40	1.5	Wood
000308	165	20	52	1.6	Wood
000309	184	30	40	2.6	Wood
000310	190	30	24	2.6	Wood
000311	190	30	40	2.6	Wood
000301	190	30	60	2.8	Aluminium and plastic
000315	215	30	48	2.6	Wood
000316	215	30	60	2.6	Wood
000313	216	30	64	2.8	Wood
000314	250	30	84	3.0	Wood

TREND BUSHING WASHERS



Used to alter the bore size of Trend circular saw blades

Product code	Diameter (mm)	Bore (mm)	Thickness (mm)	Suitable for blade size (mm)
000164	30	20	1.5	190-235
000165	30	20	1.7	250
000161	20	16	1.1	Up to 180
000162	30	16	1.5	190-235
000163	30	16	1.7	250

POWERTOOL ACCESSORIES



BANDSAW BLADE

Dimensions:
1425 x 6.35 x 0.35mm

Suitable for non-ferrous metals,
plastics and wood

6 TPI



Product code: 008931

BOSCH THIN METAL CUTTING DISCS

BEST SELLER

Diameter: 115mm

Thickness: 1mm

Sold individually or in a tin of 10



Product code: 009824

BOSCH CARBIDE MULTI-WHEEL

Ideal for cutting wood, plastic,
plaster and copper pipes

Size: 115mm

Bore: 22.23mm



Product code: 009365

BOSCH RUBBER BACKING PAD

To suit fibre sanding discs on
angle grinders

M14

Size: 115mm







Product code: 000677

BOSCH CUTTING/GRINDING DISCS					
	Product code:	Diameter (mm)	Bore (mm)	Thickness (mm)	Application
	000737	115	22.2	6.0	Grinding
	000736	115	22.2	2.5	Cutting
	000739	230	22.2	6.0	Grinding
	000738	230	22.2	3.0	Cutting
	000741	300	20.0	3.5	Cutting
	000740	355	25.4	2.8	Cutting

POWERTOOL ACCESSORIES



POWERTOOL
ACCESSORIES

ANGLE GRINDER FLANGE SET - M14		UNIVERSAL CHUCK KEY		STANDARD BIT		
Pin drive holes at 30mm spacing		Painted zinc alloy body 4 heads for most 10 & 13mm chucks		Sold individually Premium quality		
Product code: 002469		Product code: 002505		Product code:	Drive	Length (mm)
SDS PLUS CHUCK						
Allows standard 13mm chuck to be fitted to an SDS plus rotary hammer						
Product code: 000735						
	IMPACT BITS					
	Product code:	Drive	Length (mm)	Product code:	Drive	Length (mm)
	001720	PH2	25mm	001730	PH1	89mm
	001721	PH3	25mm	001731	PH2	89mm
	001722	PZ2	25mm	001732	PH3	89mm
	001723	PZ3	25mm	001733	PZ1	89mm
	001724	TX25	25mm	001734	PZ2	89mm
	001755	TX30	25mm	001735	PZ3	89mm
	001725	PH2	50mm	001736	TX10	89mm
	001726	PH3	50mm	001737	TX15	89mm
	001727	PZ2	50mm	001754	TX20	89mm
	001728	PZ3	50mm	001738	TX25	89mm
	001729	TX25	50mm	001739	TX30	89mm
	001756	TX30	50mm	001740	TX40	89mm

POWERTOOL ACCESSORIES

POWERTOOL
ACCESSORIES

SCREWDRIVER BIT TIC TAC BOXES

Brand may vary



Product code:	Drive	Length (mm)	Impact rated	Pack size
007559	PZ2	25mm	No	25
007560	PH2	25mm	No	25
007987	PZ2	25mm	Yes	25
007988	PH2	25mm	Yes	25

FAITHFULL SCREWDRIVER BIT SET - 32 PCE



7 x 25mm Pozidrive Bits: PZ0, PZ1, PZ2 (x4), PZ3
 4 x 25mm Phillips Bits: PH0, PH1, PH2, PH3
 5 x 25mm Slotted Bits: 3, 4, 5, 6, 7mm
 7 x 25mm Hex Bits: 2, 3, 4, 5, 6, 7, 8mm
 7 x 25mm TORX (Star) Security Bits: TTX10, TTX15, TTX20, TTX25, TTX27, TTX30, TTX40
 1 x 1/4in Hex to 1/4in Square Drive Adaptor
 1 x 1/4in Quick-Release Magnetic Ejector Bit Holder

Product code: 007991

FAITHFULL SCREWDRIVER BIT SET - 61 PCE



6 x Phillips Screwdriver Bits: PH0, PH1, PH2(3) & PH3
 6 x Pozidrive Screwdriver Bits: PZ0, PZ1, PZ2(3) & PZ3
 5 x Slotted Screwdriver Bits: 3, 4, 5, 6 & 7mm
 12 x Hex Screwdriver Bits: 1.5, 2, 2.5, 3, 3.5, 4, 4.5, 5, 5.5, 6, 7 & 8mm
 13 x Star Screwdriver Bits: T5, T6, T7, T8, T9, T10, T15, T20, T25, T27, T30, T35 & T40
 7 x Tamperproof Star Screwdriver Bits: TT10, TT15, TT20, TT25, TT27, TT30 & TT35
 6 x Hex Security Screwdriver Bits: 2, 2.5, 3, 4, 5 & 6mm
 5 x Spanner Bits: 4 (2), 6, 8 & 10mm
 1 x Magnetic Bit Holder 60mm

Product code: 007464

DEWALT IMPACT BIT SET - 32 PCE



10 x Pozidrive 25mm Screwdriving Bits: PZ1 (2), PZ2 (5) and PZ3 (3)
 7 x Phillips 25mm Screwdriving Bits: PH1, PH2 (3), PH3 and PR2 (2)
 3 x Slotted 25mm Screwdriving Bits: SL6, SL8 and SL10
 11 x Torx 25mm Screwdriving Bits: T10 (2), T15 (2), T20 (2), T25 (2), T27, T30 and T40
 1 x Magnetic Bit Tip Holder

Product code: 007954

POWERTOOL ACCESSORIES

We Cut Keys!

POWERTOOL
ACCESSORIES

WERA BI-TORISON BET SET - 30PCE

Premium quality



Product code: 001788

SCREWDRIVER BIT SET - 25MM

33 pce

Contains popular drives



Product code: 002568

SECURITY BIT SET - 50MM

33 pce

Contains popular drives



Product code: 002481

SECURITY BIT SET - 98 PCE

1/4" hex drive security bits

Contents:
17 x 75mm bits
79 x 25mm bits
60mm bit holder
25mm connector



Product code: 002522

EXTRA-LONG BIT SET - 9 PCE

Length: 150mm

Contains slotted, pozi and phillips bits



Product code: 002567

BOSCH RATCHETING SCREWDRIVER SET

**BEST
SELLER**

27 pce



Product code: 009578

POWERTOOL ACCESSORIES



POWERTOOL
ACCESSORIES

WERA UNIVERSAL MAGNETIC BIT HOLDER

1/4" hex drive
Stainless sleeve
Strong permanent magnet and retaining ring
Sizes in stock:



Product code: 50mm: 001809
75mm: 001802 152mm: 001808

BIT HOLDER SET

1/4" hex drive
Sizes: 60, 100 & 150mm



Product code: 002538

WERA IMPACT BIT HOLDER

Retaining ring and magnet
1/4" hex drive
Stainless steel holder



Product code: 001798

WERA MAGNETIC IMPACT BIT HOLDER

Retaining ring and magnet
Double torsion spring to absorb extreme impulse peaks
1/4" hex drive



Product code: 001799

WERA RAPIDAPTOR BI-TORSION BIT HOLDER

1/4" hex drive
Torsion zone to absorb peak loads
Allows bit take up without needing to actuate the sleeve
Size: 75mm



Product code: 001803

WERA RAPIDAPTOR UNIVERSAL BIT HOLDER WITH RING MAGNET

1/4" hex driver
Rapidaptor technology for rapid bit change
Ring magnet and stop sleeve
Size: 57mm



Product code: 001804

POWERTOOL ACCESSORIES



POWERTOOL
ACCESSORIES

ANGLED MAGNETIC SCREWDRIVER ATTACHMENT

For driving in confined areas
 1/4" hex drive
 Angle: 45 degree
 Length: 130mm



Product code: 002554

FLEXI BIT HOLDER

1/4" hex shank
 Length: 175mm
 For accessing hard-to-reach areas



Product code: 008624

MAGNETIC SOCKET DRIVER

Ideal for use with
 self-drilling screws
 Size: 8mm



Product code: 004519

SDS PLUS SOCKET DRIVER SET - 3 PCE

Converts SDS plus drills to
 socket driver
 Contents: 1/4", 3/8" and 1/2"



Product code: 002517

SOCKET DRIVER SET - 3 PCE

1/4" hex shank
 Sizes: 1/4", 3/8" & 1/2" sockets



Product code: 002542

ROTARY RASP SET

For use with power drills
 and die grinders
 Shank: 6.35mm



Product code: 002493

POWERTOOL ACCESSORIES



DRILL SAW SET

Titanium coated HSS
To cut wood, plastic, plasterboard and aluminium
Sizes in pack: 3, 6 and 8mm



Product code: 008649

FAITHFULL MULTITOOL BLADE SET - 7 PCE

Universal fitting
Contains blades to cut both wood and metal



Product code: 007152

ADDAX MULTI-TOOL BLADES

Universal fitting



Product code:	Cut size (mm)	Blade type	Cut type	Material
004411	10	Straight	Fine cut	Wood
004413	32	Straight	Fine cut	Wood
004412	32	Straight	Coarse cut	Wood
008534	32	Straight	Fine cut	Wood/metal
004414	52	Flexible	Scraper	Paint/glues /silicones
004416	69	Straight	Fine cut	Wood
004415	69	Straight	Coarse cut	Wood
004417	69	Serrated edge	N/A	Soft materials eg) Cardboard
004418	59	Diamond boot	N/A	Grout removal
004419	65	Diamond radial	N/A	Tiles, plaster and porous concrete
004420	87	Radial	N/A	Wood
004421	87	Radial	N/A	Wood/metal

POWERTOOL ACCESSORIES



POWERTOOL
ACCESSORIES

TREND MULTI-TOOL BLADES

Universal fitting



Product code:	Cut width (mm)	Cut depth (mm)	Blade type	Materials	Plunge cut	Blade thickness (mm)
000296	64	41	Tapered	Wood with nails, metal, PVC, plasterboard	No	0.6
000292	64	41	Tapered	Hardwood, Wood	No	0.6
000291	64	41	Tapered	Wood, plasterboard, PVC	No	0.6
000287	95	28	Straight	Wood, PVC	Yes	0.9
000290	30	41	Straight	Hardwood/Wood	No	0.6
000289	30	41	Straight	Wood, plasterboard, PVC	Yes	0.6
000293	30	41	Straight	Wood with nails, metal, PVC & plasterboard	Yes	0.6
000295	30	41	Straight	Wood with nails, metal, PVC & plasterboard	Yes	0.6 (TCT)
000294	30	54	Straight	Wood with nails, metal, PVC, plasterboard	Yes	0.6
000288	30	66	Straight	Wood,PVC	Yes	0.6
000297	44	41	Straight	Wood with nails, metal, PVC, plasterboard	Yes	0.6
000298	80	25	Radial	Sheet metal (up to 1mm thick), hardwood, softwood, fibreglass	No	0.6
000299	50	28	Scraper	Caulk, paint, tiles, carpet, insulation foam	N/A	0.8

TREND MULTITOOL BLADE PACK - 6 PCE

Titanium coated for longer life
Contents:



Cut width (mm)	Cut depth (mm)	Number in pack
30	54	2
30	41	2
44	41	2

BOSCH MULTITOOL DELTA SANDING PAD

Size: 93mm
Starlock fitting



Product code: 000663

POWERTOOL ACCESSORIES



BOSCH MULTITOOL PLUNGE CUT BLADE

Bi-metal
Starlock fitting
Cutter width: 20mm
5-pack



Product code: 000664

BOSCH MULTITOOL BLADE SET - 3 PCE

Starlock fitting
Contains blades to cut both wood and metal



Product code: 007926

PALM SANDER SHEETS

5-pack
Size: 115 x 140mm



Product code:

Grit

002387

60

002389

80

002388

120

HOOK AND LOOP SANDING DISCS

5-pack
Size: 125mm



Product code:

Grit

002384

60

002385

120

002386

240

HOOK AND LOOP DELTA SANDING DISCS

Size: 93 x 93mm
Pack of 5

Suitable for wood, plastic, metal and fibre-glass

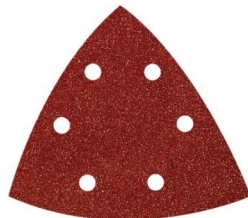

Product code:

Grit

004005

40

004006

60

004007

80

004008

120

004009

220

ZIRCONIUM FLAP DISC

Size: 115 x 22mm

For use on stainless steel, sheet metal, mild and high-grade steel

Grits in stock:



Product code: 40G: 004001 60G: 004002
80G: 004003 120G: 004002

POWERTOOL ACCESSORIES

We Cut Keys!

POWERTOOL
ACCESSORIES

SANDING BELTS - ALUMINIUM OXIDE

Suitable for wood, metal and filler



Product code	Width (mm)	Length (mm)	Grit
004016	75	533	40
004017	75	533	60
004018	75	533	80
004015	75	533	100
004020	100	610	40
004021	100	610	60
004022	100	610	80
004019	100	610	100

SPINDLE MOUNTED FLAP WHEELS

Designed for use with electric drills and air tools

For use on mild steel, alloy steel and iron

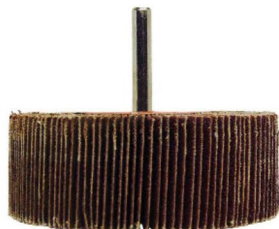

Product code	Dimensions (mm)	Grit
004052	25 x 15	60
004053	50 x 30	60
004054	80 x 50	60

TWIST KNOT CUP BRUSH

Suitable for angle grinders and other specialist machinery

M14 thread

Sizes in stock:



Product code: 70mm: 004026 95mm: 004028

CRIMP CUP BRUSH

Suitable for angle grinders and other specialist machinery

M14 thread

Sizes in stock:



Product code: 75mm: 004027 100mm: 004029

SPINDLE MOUNTED CRIMPED BRUSHES

6mm spindle

Suitable for metal rust and paint



Product code	Brush type	Size (mm)
004031	Circular	50mm
004032	Cup	50mm
004033	Cup	75mm

POWERTOOL ACCESSORIES



POWERTOOL
ACCESSORIES

BENCH GRINDER BRUSH

Size: 150 x 20mm
Crimped wire



Product code: 004039

FILAMENT CIRCULAR BRUSH - NON SPARK

Coarse
Size: 100mm

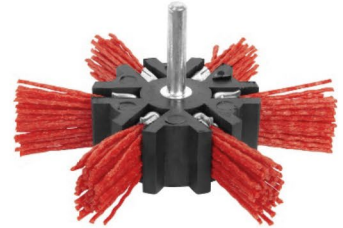

Product code: 004034

CRIMPED WIRE BEVEL BRUSH

Diameter: 115mm
M14 thread - suitable
for angle grinders



Product code: 004030

ASSORTED MOUNTED POINT PACK

6mm spindle
Assorted sizes
10 pce



Product code: 007441

POLISHING KIT - 10 PCE

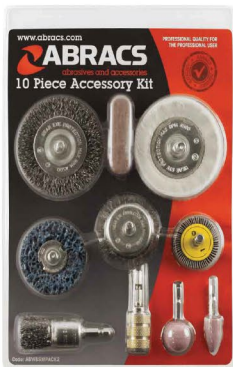

Product code: 004038

SPINDLE MOUNTED SCRATCH BRUSH PACK

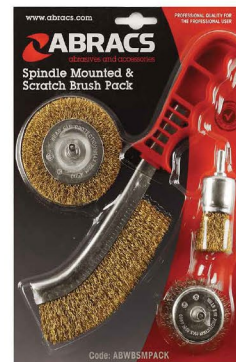

Product code: 004037

POWERTOOL ACCESSORIES



POWERTOOL
ACCESSORIES



TREND KITCHEN WORKTOP JIG

Length: 1185mm
Width: 390mm
Thickness: 12mm
End cut: 45 degrees
Corner mitre joint: 45 degrees
Corner radius: 40mm, 100mm, 400mm
For worktops up to 900mm



Product code: 000148

TREND HINGE JIG

Designed for recessing hinges in wooden doors and frames with a plunge router

Length range: 67 - 127mm
Width range: 9.5 - 35mm
Door height: 1955 - 2100mm
Minimum door width: 16mm



Product code: 008866

TREND LOCK JIG

For door thickness between 34 and 58mm thick

Requires a 1/2" plunge router with 80mm depth and 30mm guide bush with a 6mm spigot

For use with a 12mm long reach cutter

For most common mortice sash and deadlocks



Product code: 000149

EURO LOCK JIG

Contents:
1 x template with sliding aperture
2 x Edge guides
1 x Spacer pack



Product code: 000147

TREND STANDARD POCKET HOLE JIG

For timber thicknesses between 16 - 38mm

Hole pitch: 29 - 63mm



Product code: 000150

TREND SINGLE POCKET HOLE JIG

For timber thicknesses of 12 - 38mm

Built in drill depth gauge



Product code: 009927

POWERTOOL ACCESSORIES



POWERTOOL
ACCESSORIES

TREND ROUTER GUIDE BUSHES

000201 fits directly to a Trend T4 router

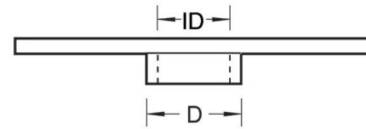

Product code:	Outside Dia (mm)	Inside Dia (mm)	Projects from plate (mm)	Plate Dia (mm)	Screw centres (mm)
000221	30	27	6	60	50
000158	30	27	10	60	50
000202	16	14	10	60	50
000201	16	14.9	n/a	60	n/a
010028	20	17	6	60	50

TREND GUIDE BUSH SCREWS

10 pack



Product code: 000200

TREND LOCATION PINS FOR WORKTOP JIGS

4 pack



Product code: 000205

TREND ROUTER CUTTER BEARINGS



Product code	Outer diameter (mm)	Inner diameter (mm)	Thickness (mm)
000169	19	6	6
008947	15.9	6.35	4.7
000168	12.7	4.7	4.7

POWERTOOL ACCESSORIES



POWERTOOL
ACCESSORIES



TREND ROUTER COLLETS



Product code:	Trend router to suit	Diameter
000175	T10 and T11	6.35 (1/4")
000174	T10 and T11	12.7 (1/2")

TREND POCKET HOLE JIG DRILLS

Ideal for hardwoods, softwoods, plywood, MDF and chipboard
For use with Trend pocket hole jigs



Product code:	Drill dia (mm)	Pilot dia (mm)	Overall length (mm)	Shank type
000208	9.5	4.2	155	Straight standard
000209	9.5	4.2	178	Quick chuck

TREND POCKET HOLE SCREWS

500 pack
Square drive
Self-tapping screw
Ideal for hardwoods



Product code:	Thread type	Thread size	Length (mm)
000206	Fine	No 7	30
000207	Coarse	No 7/8	30

TREND PLANER BLADES

Packs of 2

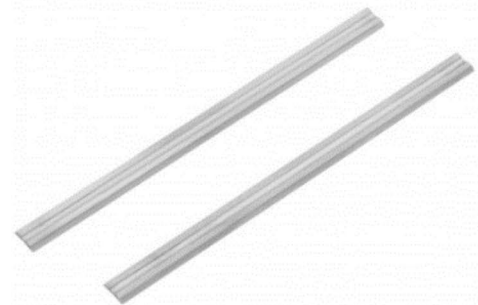

Product code:	Blade length (mm)	Blade width (mm)	Blade thickness (mm)
008844	82	5.5	1.1
000177	80.5	5.9	1.2

POWERTOOL ACCESSORIES



POWERTOOL
ACCESSORIES

TREND COLLET REDUCING SLEEVE

Used to reduce the collet size of a Trend router

Not recommended for heavy use or as a permanent solution

Reduces collet size from 1/2" to 1/4"

Total length: 30mm



Product code: 000176

TREND UNIBASE

Enables routers with non-standard guide bush fittings to accept the Trend range of guide bush fittings



Product code: 000225

MICRO-FILTER BAGS FOR TREND T32 VACUUM

BEST SELLER

For dry use only

Increased performance and heavier duty



Product code: 008555

SNAPPY COUNTERSINK SET

For use with Snappy quick release system

5-pce

Contents: 2, 2.5, 2.75, 3.25 & 3.5mm drill bits



Product code: 000285

SNAPPY COUNTERSINK AND PILOT DRILL

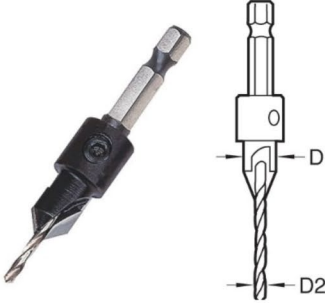
 <p>For use with Snappy quick release system</p>	Product code:	D (mm)	D2 (mm)	Screw size (Gauge)	TCT
	000245	9.5	2.75	6 (hardwood), 8 (Softwood)	Yes
000242	9.5	3.25	10	Yes	
000243	12.7	3.5	10 (hardwood), 12 (Softwood)	Yes	
000244	9.5	2.5	6	No	
000284	9.5	2.75	6 (hardwood), 8 (Softwood)	No	
000283	9.5	3.25	8 (hardwood), 10 (softwood)	No	

POWERTOOL ACCESSORIES

We Cut Keys!

trend[®]
routing technology

POWERTOOL
ACCESSORIES

SNAPPY DRILL AND COUNTERBORE

For use with Snappy quick release system

For use with plug cutters to hide screws below the surface
TCT for use in abrasive materials

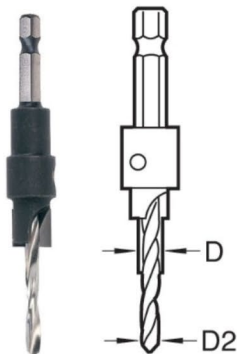

Product code:	D (mm)	D2 (mm)
000240	9.5	4.75
000282	12.7	4.75

SNAPPY SPARE DRILL BIT FOR COUNTERBORE

HSS

Drill diameter: 4.75mm

Overall length: 75mm



Product code: 000236

SNAPPY STUBBY AUGER BITS

For use with Snappy quick release system



Product code:	Diameter (mm)	Overall length (mm)
000277	13	105
000278	16	105
000279	19	105
000280	25	105
000281	32	105

SNAPPY PLUG CUTTERS

To suit Snappy quick release system



Product code:	Plug size (mm)	Outside diameter (mm)
000286	12.7	19
000266	9.5	15.75

POWERTOOL ACCESSORIES



POWERTOOL
ACCESSORIES

SNAPPY FLAT BITS

For use with Snappy quick release system



Product code:	Diameter (mm)	Overall length (mm)
000229	10	152
000230	12	152
000231	16	152
000232	20	152
000233	22	152
000234	25	152
000235	32	152

SNAPPY DRILL BIT GUIDE

For use with Snappy quick release system

Perfect for making centralised pilot holes when fitting ironmongery



Product code:	Drill diameter (mm)	Screw size
000250	2.0	3.5 (No 6)
000251	2.75	4.0 (No 8)
000252	3.5	5.0 (No 10)
000249	4.36	5.5 (No 12)

SNAPPY COUNTERSINK

For use with Snappy quick release system

For use on hard and softwoods

Diameter: 15.8mm

A: 49 degrees

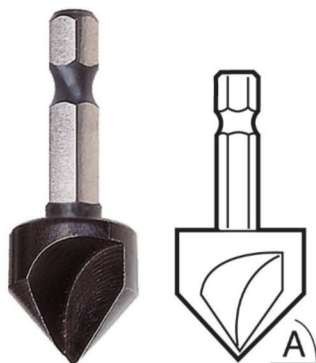

Product code: 000246

SNAPPY DRILL DEPTH SETTING COLLAR

For use with Snappy quick release system

Can adjust position to suit depth of dowel drilling

Contents: 6, 8, 10mm collars and hex key



Product code: 000241

POWERTOOL ACCESSORIES



POWERTOOL
ACCESSORIES



TREND BISCUITS



Product code:	Biscuit size	Pack size
000217	0	100
000218	10	100
000219	20	100

DOWELS



Product code:	Diameter (mm)	Length (mm)	Pack size
008586	6	30	50
008587	8	30	50
008588	10	35	50

TREND DAMAGED SCREW AND BOLT REMOVER SET

Screw sizes: No6 - No14
(3.5mm - 6.5mm)
Bolt sizes: M4 - M8



Product code: 000203

SNAPPY SQUARE DRIVE ADAPTOR

For use with Snappy quick release system
For use with drills or impact drivers



Product code:	Drive (inches)	Overall length (mm)
000270	1/4"	50
000271	3/8"	50

POWERTOOL ACCESSORIES



SNAPPY QUICK CHUCK

The heart of the Trend Snappy system

Converts a standard drill/driver into a Snappy quick release system

3/8 hex shank

Overall length: 56mm



Product code: 000268

SNAPPY MAGNETIC BIT HOLDER

For use with Snappy quick release system

High powered ring magnet and bit holder

Complete with PZ2 bit

Driving depth adjustment

Overall length: 62mm



Product code: 000261

SNAPPY MAGNETIC QUICK CHUCK

Accepts Snappy style fitting tools

Will hold woodscrews when used with insert bits

Small diameter: 15mm

Overall length: 60mm

Shank diameter: 1/4"



Product code: 000269

SNAPPY KEYLESS CHUCK

Converts quick chucks to standard parallel shank system

Allows for fast swaps between Snappy and standard accessories

Capacity: 6mm

Outside diameter: 38mm



Product code: 000257

SNAPPY MAGNETIC NUT DRIVERS



For use with Snappy quick release system

Product code:	Nut head size (mm)	Bolt thread size	Overall length (mm)
000264	7	M4	65
000265	8	M5	65
000262	10	M6	65
000263	13	M8	65

SNAPPY DRILL BITS



To suit Snappy countersinks

Product code:	Drill diameter (mm)	Overall length (mm)	Pack size
000274	2.0 (5/64)	52.5mm	10
000273	2.5 (3/32)	60mm	10
000275	2.75 (7/64)	68.5mm	10
000248	2.75 (7/64)	Extra long to suit drill bit guide	5
000272	3.25 (1/8)	71.5mm	10

POWERTOOL ACCESSORIES



POWERTOOL
ACCESSORIES



SNAPPY DRILL BITS - 10 PCE MULTI PACK		SNAPPY PZ2 INSERT BITS	
<p>To suit Snappy countersinks</p> <p>Contents: 2 x 2mm 2 x 2.5mm 2 x 2.75mm 2 x 3.25mm 2 x 3.5mm</p>		<p>20 pack</p> <p>Titanium nitride coated</p> <p>Length: 25mm</p>	
Product code: 000247		Product code: 000260	

SNAPPY ONE TOUCH BIT HOLDER	SNAPPY STANDARD MAGNETIC BIT HOLDER	SNAPPY MICRO-DIAMETER BIT HOLDER	
<p>High powered magnet</p> <p>Diameter: 10.3mm</p> <p>Overall length: 150mm</p>		<p>To suit Snappy quick release system</p> <p>To suit standard 25mm insert bits</p> <p>Diameter: 9.4mm</p> <p>Length in stock: 152mm</p>	
Product code: 000228		Product code: 000237	
		Product code:	Overall length (mm)
		000238	66
		000239	150

POWERTOOL ACCESSORIES



POWERTOOL
ACCESSORIES

SNAPPY INSERT BITS



Product code:	Drive	Overall length (mm)	Pack size
000259	PZ2	25	10
000258	PH2	25	10

SNAPPY GLASS DRILL BITS

To suit snappy quick release system
Perfect for drilling through glass, porcelain, ceramic tiles and mirrors

Not for use on toughened glass

Best performance when used with cooling aid



Product code:	Drill diameter (mm)
008826	6
008827	7
008828	8
008829	10

SNAPPY DOWEL DRILL



To suit Snappy quick release system

Product code	Drill diameter (mm)	Total length (mm)
000254	6	110
000255	8	117
000253	10	130

SNAPPY DRYWALL BITS - WITH DEPTH STOP

2 pack

Drive: PH2



Product code: 000276



JANITORIAL

Mitchells
Ironmongers

JANITORIAL



JANITORIAL

<p>GALVANISED MOP BUCKET</p>	<p>PLASTIC MOP BUCKET</p>	<p>COTTON SOCKET MOP HEAD</p>											
	<p>Colour may vary</p> 	<p>Requires 23mm handle</p> 											
<p>Product code: 002924</p>	<p>Product code: 009874</p>	<p>Product code: 002886</p>											
<p>SILK-FREE CLEANING RAGS - 10KG</p>	<p>TOILET ROLL</p>	<p>CLEANING FLUIDS</p>											
	<p>Pack of 36 2-ply</p> 	<p>5 litres</p> 											
<p>Product code: 002861</p>	<p>Product code: 002862</p>												
<p>CHANNEL BLOCKS</p>	<p>SMALL FORCE CUP PLUNGER</p>	<table border="1"> <thead> <tr> <th>Product code:</th> <th>Product</th> </tr> </thead> <tbody> <tr> <td>002863</td> <td>Bleach</td> </tr> <tr> <td>002864</td> <td>Detergent</td> </tr> <tr> <td>002865</td> <td>Multi-clean</td> </tr> <tr> <td>002866</td> <td>Pine disinfectant</td> </tr> </tbody> </table>		Product code:	Product	002863	Bleach	002864	Detergent	002865	Multi-clean	002866	Pine disinfectant
Product code:	Product												
002863	Bleach												
002864	Detergent												
002865	Multi-clean												
002866	Pine disinfectant												
<p>Weight: 2.5Kg</p> 	<p>Size: 75mm</p> 												
<p>Product code: 002870</p>	<p>Product code: 002890</p>												
<p>LARGE FORCE CUP PLUNGER</p>	<p>MASTER PLUNGER</p>	<p>MICRO PLUNGER</p>											
<p>Size: 120mm</p> 	<p>Size: 125mm</p> 	<p>Size: 100mm</p> 											
<p>Product code: 002891</p>	<p>Product code: 002892</p>	<p>Product code: 002893</p>											

JANITORIAL



JANITORIAL

<p>LAVATORY BRUSH AND HOLDER</p>	<p>SMALL WASTE PIPE CLEANER</p>	<p>LARGE WASTE PIPE CLEANER</p>																											
	<p>Corkscrew end and integrated handle</p> <p>Size: 1800mm x 6mm diameter</p> 	<p>Corkscrew probe and plastic handle</p> <p>Size: 10m x 9mm diameter</p> 																											
<p>Product code: 002958</p>	<p>Product code: 002516</p>	<p>Product code: 002531</p>																											
<p>DRAIN ROD SET - LOCKFAST</p>	<p>DRAIN ROD SET - UNIVERSAL</p>	<p>DRAIN ROD ACCESSORIES</p>																											
<p>Premium quality</p> <p>Includes: 10 x rods 2 x 12-inch straps 1 x 4-inch plunger 1 x 2-inch double worm screw</p> <p>Fitting type: lockfast</p> 	<p>Premium quality</p> <p>Includes: 10 x rods 1 x carry bag 1 x 4-inch plunger 1 x 4-inch drop scraper 1 x 2-inch double worm screw</p> <p>Fitting type: universal</p> 	<table border="1"> <thead> <tr> <th>Product code:</th> <th>Accessory</th> <th>Fitting type</th> </tr> </thead> <tbody> <tr> <td>002876</td> <td>Double worm screw</td> <td>Universal</td> </tr> <tr> <td>002879</td> <td>Double worm screw</td> <td>Lockfast</td> </tr> <tr> <td>002877</td> <td>4-inch plunger</td> <td>Universal</td> </tr> <tr> <td>002880</td> <td>4-inch plunger</td> <td>Lockfast</td> </tr> <tr> <td>002878</td> <td>6-inch plunger</td> <td>Universal</td> </tr> <tr> <td>002881</td> <td>6-inch plunger</td> <td>Lockfast</td> </tr> <tr> <td>002875</td> <td>4-inch drop scraper</td> <td>Universal</td> </tr> <tr> <td>002882</td> <td>16-inch Woodstock brush</td> <td>Universal</td> </tr> </tbody> </table>	Product code:	Accessory	Fitting type	002876	Double worm screw	Universal	002879	Double worm screw	Lockfast	002877	4-inch plunger	Universal	002880	4-inch plunger	Lockfast	002878	6-inch plunger	Universal	002881	6-inch plunger	Lockfast	002875	4-inch drop scraper	Universal	002882	16-inch Woodstock brush	Universal
Product code:	Accessory	Fitting type																											
002876	Double worm screw	Universal																											
002879	Double worm screw	Lockfast																											
002877	4-inch plunger	Universal																											
002880	4-inch plunger	Lockfast																											
002878	6-inch plunger	Universal																											
002881	6-inch plunger	Lockfast																											
002875	4-inch drop scraper	Universal																											
002882	16-inch Woodstock brush	Universal																											
<p>Product code: 002874</p>	<p>Product code: 002884</p>																												
<p>MULTIPURPOSE CLEANER SPRAY</p>	<p>CLEAR WINDOW AND MIRROR CLEANER SPRAY</p>																												
<p>Size: 750ml</p> 	<p>Size: 750ml</p> 																												
<p>Product code: 002869</p>	<p>Product code: 002868</p>																												
<p>TRIGGER SPRAY BOTTLE</p>	<p>MR MUSCLE</p>	<p>LARGE SCOURING PAD</p>																											
<p>Colour may vary</p> <p>Size: 1L</p> 		<p>Size: 90 x 140mm</p> <p>Pack of 10</p> 																											
<p>Product code: 002894</p>	<p>Kitchen : Bathroom: 009823 Kitchen: 009926</p>	<p>Product code: 009984</p>																											

JANITORIAL



JANITORIAL

JUMBO SPONGE



Product code: 002901

MIGHTY CLOTH



Sold as a pack of 5
Very absorbent general-purpose cloth

Product code: 009248

BATHROOM DRAIN UNBLOCKER

Size: 500ml



Product code: 009639

JEYES FLUID

Specialist outdoor cleaner
Cleaner and disinfectant
DEFRA approved
Sizes in stock:

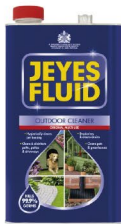

Product code: 1L: 002661
5L: 002872

WHITE CENTREFEED ROLL

Roll length: 150m
Available as singles or
in a pack of 6



Product code: 002955

RAT KILLER GRAIN BAIT

1 sachet kills
up to 4 rats

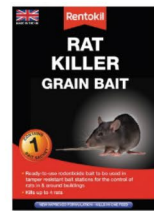

Product code: 002871

RAT TRAP



Product code: 002902

RAT CAGE

Size: 300 x 150
x 130mm



Product code: 002476

MOUSE TRAP

Box of 2



Product code: 002895

BIRD SPIKES - 10PK

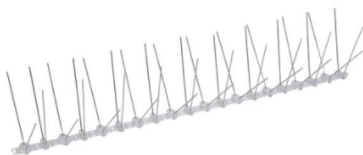

Width: 500mm
Spike length: 105mm
2 spike

Product code: 002477

ANT KILLER POWDER

Size: 150g
Not for use on soft
furnishings



Product code: 002899

ANT CONTROL SYSTEM



Twin pack

Product code: 002898

JANITORIAL



JANITORIAL

<p>XTRA TOUGH WEEDKILLER</p>	<p>GALVANISED WATERING CAN</p>	<p>LINE POST - 2.4M</p>
<p>Ideal for the control of annual and perennial weeds</p> <p>Contains glyphosphate</p> <p>Available as ready to use or concentrated</p> <p>Sizes in stock:</p> 		
<p>Product code: 1L: 002927 1L concentrate: 002951 3L: 002949</p>	<p>Product code: 009461</p>	<p>Product code: 003044</p>
<p>PLASTIC WATERING CAN - 9L</p>	<p>MINI GALVANISED DUSTBIN & LID</p>	<p>GALVANISED MINI INCINERATOR AND LID</p>
		
<p>Product code: 003993</p>	<p>Product code: 002904</p>	<p>Product code: 002925</p>
<p>GALVANISED DUSTBIN WITH LID</p>	<p>GALVANISED INCINERATOR AND LID</p>	<p>BLACK PLASTIC DUSTBIN WITH LID</p>
<p>Size: 80L - Size may vary depending on manufacturer</p> 	<p>Size: 80L - Size may vary depending on manufacturer</p> 	<p>Size: 80L</p> 
<p>Product code: 002915</p>	<p>Product code: 002917</p>	<p>Product code: 002916</p>
<p>BLACK COAL SCUTTLE</p>	<p>GALVANISED HOD</p>	<p>WINDSOR COMPANION SET</p>
		
<p>Product code: 002908</p>	<p>Product code: 002918</p>	<p>Product code: 002909</p>

JANITORIAL



JANITORIAL

<p>BLACK WATERLOO BUCKET</p>	<p>GALVANISED BUCKET</p>	<p>WATER CONTAINER</p>
	<p>Size: 12L</p> 	<p>Size: 25L</p> 
<p>Product code: 002907</p>	<p>Product code: 002914</p>	<p>Product code: 002929</p>
<p>WATER CONTAINER TAP</p>	<p>LITTER PICKER</p>	<p>HEAVY DUTY REFUSE SACK</p>
<p>Chamfered outlet spout - 23mm</p> <p>Dispenses at 5L per minute</p> <p>To suit 25L water container</p> 	<p>Size: 87cm</p> 	 <p>Size: 735 x 970mm Pack of 10</p>
<p>Product code: 009278</p>	<p>Product code: 002887</p>	<p>Product code: 002913</p>
<p>HEAVY DUTY RUBBLE SACK</p>	<p>BLACK REFUSE SACKS</p>	<p>WHEELIE BIN BAGS</p>
 <p>Size: 530 x 810mm Pack of 6</p>	 <p>Size: 18 x 29 x 39" 200G Box of 200</p>	 <p>Size: 30 x 46 x 54" 160G Box of 100</p>
<p>Product code: 009356</p>	<p>Product code: 002953</p>	<p>Product code: 002952</p>
<p>DUSTPAN AND BRUSH</p>	<p>FLUE BRUSH</p>	<p>BOILER AND FLUE BRUSH SET</p>
	<p>Sizes in stock:</p> 	 <p>Length: 480mm Diameters: 15mm, 50mm & 50 x 16mm</p>
<p>Product code: 002957</p>	<p>Product code: 4ft: 002919 6ft: 002920</p>	<p>Product code: 002492</p>

JANITORIAL



JANITORIAL

We Cut Keys!

<p>COAL SHOVEL</p> 		<p>GARAGE/TRACTOR FUNNEL</p> 		<p>FLEXIBLE STEEL FUNNEL</p> <p>Galvanised steel Funnel diameter: 150mm Shaft length: 240mm</p> 	
<p>Product code: 002526</p> <p>Size (mm): 100</p>		<p>Product code: 002889</p>		<p>Product code: 002555</p>	
<p>Product code: 002552</p> <p>Size (mm): 170</p>		<p>FUNNEL SET - 4 PCE</p> <p>Sizes: 50, 75, 100 & 120mm</p> 		<p>GRADUATED POURER</p> <p>Size: 1L</p> 	
<p>Product code: 002534</p> <p>Size (mm): 230</p>		<p>Product code: 002489</p>		<p>Product code: 002529</p>	
<p>MEASURING JUG</p> <p>Size: 1 Litre</p> 		<p>MEASURING JUG</p> <p>Size: 1.5 Litre</p> 		<p>LEVER TYPE OIL CAN</p> <p>Size: 500ml</p> 	
<p>Product code: 002535</p>		<p>Product code: 002498</p>		<p>Product code 007245</p>	
<p>RADIATOR BLEED KEY - 2 PACK</p> 		<p>4-WAY UTILITIES KEY</p> <p>Compatible with water, electric and gas service cabinets</p> 		<p>COMBINATION STOP COCK KEY</p> <p>Length: 970mm Fits most 1/2" and 3/4" stop cocks</p> 	
<p>Product code: 002558</p>		<p>Product code: 002561</p>		<p>Product code: 002562</p>	



JERRY CANS



Product code:	Colour	Size (L)
002931	Green	5
009645	Green	10
002937	Green	20
002944	Red	5
002932	Red	10
002939	Red	20
002943	Black	5
002933	Black	10
002935	Black	20

JERRY CAN SPOUT



Product code:	Colour
002938	Green
002940	Red
002936	Black

FUEL CANS



Product code:	Colour	Size (Litres)
002942	Green	5
002941	Black	5
002945	Red	5

JANITORIAL



JANITORIAL

HAND CREAM

Moisturising cream designed to improve the health of skin
Size: 96g

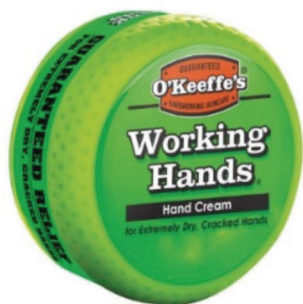

Product code: 002888

RED GEL HAND CLEANSER

Heavy duty beaded hand cleanser
For soiling's such as oil, grease, tar, and rubber
Size: 5L



Product code: 003417

SCREEN WASH - 5L



Ready mixed

Product code: 002928

DE-ICER SPRAY



Size: 500ml

Product code: 002697

SUN CREAM - SPF50+



Size: 250ml
Contains UVA and UVB agents to protect skin from burning and premature ageing

Product code: 003418



ACCESS

Mitchells
Ironmongers

ACCESS



ACCESS

DOUBLE EXTENSION LADDERS

Tested to EN 131-2
Max load capacity: 150Kg



Product code:	Closed height (m)	Open height (m)	Number of rungs
000396	2.93	4.90	10
000389	3.45	5.97	12
006958	4.04	7.14	14
000391	4.45	7.81	15
006298	4.95	8.88	17

TRIPLE EXTENSION LADDERS

Tested to EN 131-2
Max load capacity: 150Kg



Product code	Closed height (m)	Open height (m)	Number of rungs
000397	2.45	5.23	8
006249	2.93	6.92	10
000398	3.45	8.48	12

SWINGBACK STEP LADDERS

Tested to EN 131-2



Product code	Number of treads	Open height (m)
000379	5	1.01
006547	6	1.23
000380	7	1.44
000381	8	1.68
000377	10	2.13
000378	12	2.55

PLATFORM STEP LADDERS

Tested to EN 131-2



Product code	Number of treads	Open height (m)
000384	3	1.21
000395	4	1.43
000385	5	1.66
000386	6	1.87
000387	7	1.87
000388	8	2.31
000382	10	2.73
000383	12	3.18

ACCESS



GLASS FIBRE SWINGBACK STEP LADDER

Approved to the latest EN 131 standards

Non-conductive fibreglass stiles up to 30,000V



Product code:	Number of treads	Safe working height (m)
000374	6	2.59
000373	7	2.87
000375	8	3.15
000376	10	3.7

ROOF CRAWL LADDERS



Product code:	Closed length	Overall height (m)	Number of rungs	Extensions
000399	N/A	4.97	19	Single
000400	3.94	6.64	15 + 13	Double

TELESCOPIC LADDER

BEST SELLER

Certified to BS EN 131

12 tread

Closed height: 1.1m

Fully extended height: 3.77m

Dimensions may vary dependent on manufacturer



Product code: 009517

LADDER STAND-OFF



Product code: 000406

UNIVERSAL RIDGE HOOK



Product code: 000401

LADDER CLAMPS



Complete with padlocks

Product code: 000405

LADDER FEET

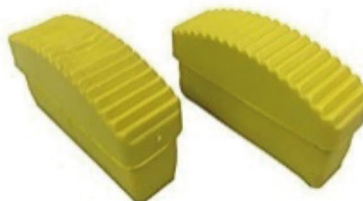

Product code:	Size (mm)
000402	58
000403	74
000404	85

ACCESS



ACCESS

STEP-UP PLATFORM



Capacity: 150Kg
Dimensions: 910 x 415 x 500mm
Certified to BS 2037

Product code: 000407

SQUARE HOP-UP



Capacity: 150Kg
Dimensions: 980 x 710 x 500mm
Certified to EN 14183:2003

Product code: 000408

MULTI-PURPOSE LADDER



Glassfibre - Tested to 30,000V
Stepladder height: 1.75m
Extension ladder length: 3.56m
Weight: 15.3kg

Product code: 009575

LYTEPOD PODIUM STEPS



Platform height: 1.225 - 1.475m
Overall height: 2.51m
Width: 0.67m
Weight: 43kg

Product code: 009574

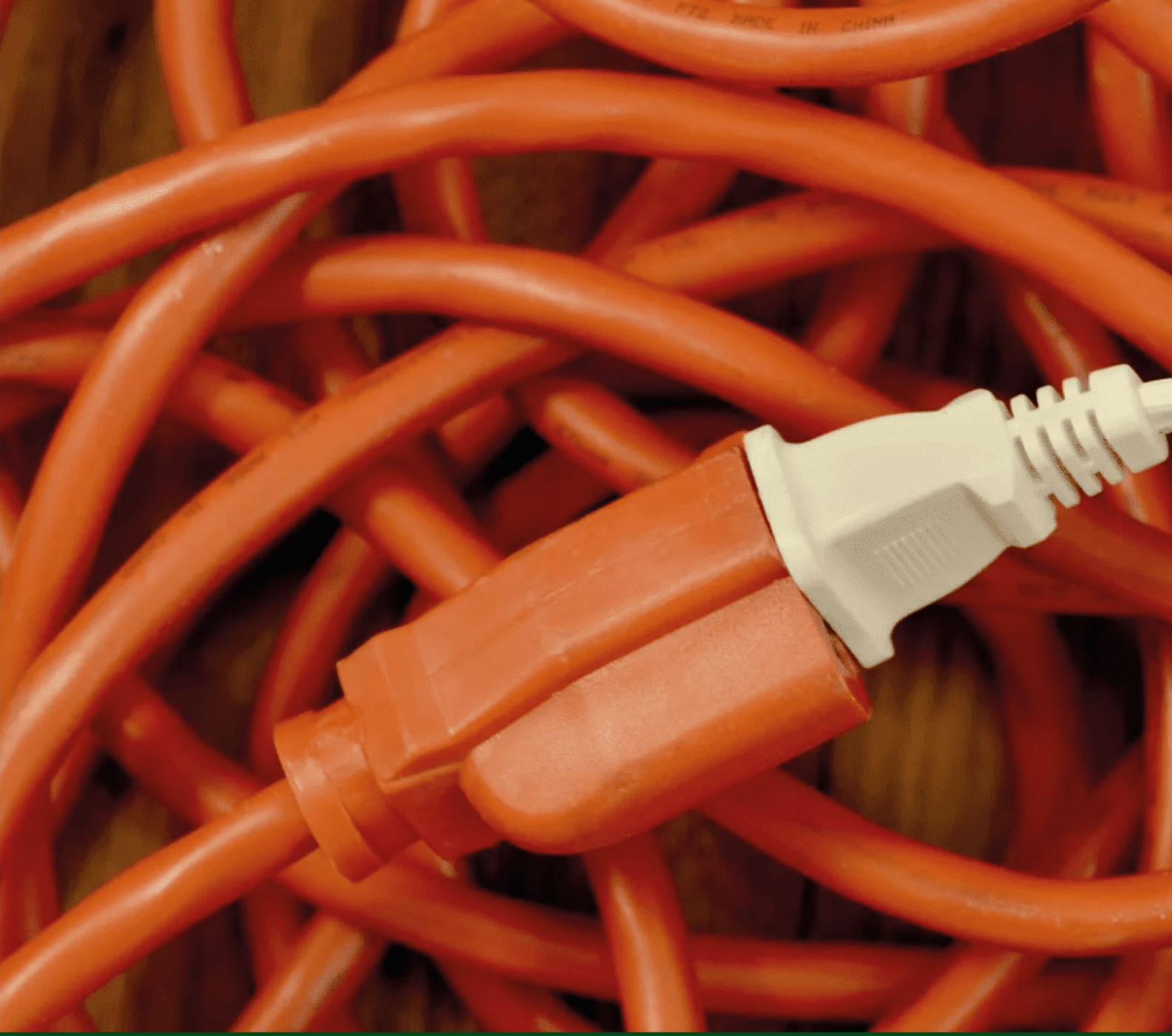

SITE ELECTRICAL

Mitchells
Ironmongers

SITE ELECTRICAL



SITE ELECTRICAL

We Cut Keys!

DURACELL BATTERIES



Product code:	Battery type	Pack size
002746	AAA	4
002747	AA	4
002745	9V	2
002749	C - LR14	2
002748	D2 - LR20	2

BUTTON CELL BATTERIES



Product code	Battery type	Pack size
009848	1.5V - LR44	4
002495	3V - CR2016	4
002509	3V - CR2025	4
002536	3V - CR2032	4

3KVA TRANSFORMER

Outlets: 2 x 16A
Cable: 1.8m/1.5mm/3 core
Fitted with 240V 13A plug
BS EN 61558-1



Product code: 002733

RCD PLUG

240V
Tripping speed: 40MS
RCD rating: 30MA
Plug: 13A



Product code: 002732

CABLE REELS



Product code	Length (M)	Voltage (V)	Outlets	Cable (mm)
002726	20m	240	4 x 13A	1.25mm
002725	25m	110	2 x 16A	1.5mm
002738	50m	240	4 x 13A	1.25mm
002737	50m	110	2 x 16A	1.5mm

DOMESTIC EXTENSION - 4 GANG



With neon indicator
3000W rating
Conforms to BS1363:1984

Product code: 008257

RCD SOCKET

240V
Tripping speed: 40MS
RCD Rating: 30MA
Plug: 13A



Product code: 002731

2 GANG FLY LEAD



13A/2 gang
Cable: 1.5mm
BS EN 50525-2-11

Product code: 002735

HEAVY DUTY 3 PIN PLUG

13A
Fused



Product code: 002752

SMOKE ALARM - TWINPACK



Ionisation smoke alarm
9V battery power
5-year warranty
Suitable for installations complying to BS 5839-6: 2013 Grade F
CE and quality Kitemark to BS EN 14604

Product code: 008256

SITE ELECTRICAL



SITE ELECTRICAL

4 GANG FLY LEAD

13A/4 gang
Cable: 1.5mm
BS EN 50525-2-11



Product code: 002736

POWER EXTENSION LEAD

110V/16A
Length: 14m
Cable: 1.5mm



Product code: 002734

4-WAY SPLITTER

110V



Product code: 006846

COUPLERS

16A
BS EN 60309
Voltages in stock:



Product code: 240V: 002742
110V: 002740

PLUGS

16A
BS EN 60309
Voltages in stock:



Product code: 240V: 002741
110V: 002739

FUSES

4 pack
Amps in stock:



Product code: 13A: 002751
5A: 002750

FESTOON KIT - LED

Power: 100W
110V
Length: 22m
Bulb fitting: ES



Product code: 002743

FESTOON HANGING HOOKS



Sold individually

Product code: 002729

LED FESTOON BULBS

Power: 10W
800 lumens
110V
Fitting: ES



Product code: 002730

FESTOON CAGE



Product code: 002728

RECHARGEABLE WORK LIGHT

BEST SELLER

Power: 20W
1400 lumens
3-6 hours use after charge
USB cable included



Product code: 009518

TWIN HEAD TELESCOPIC WORK LIGHT - LED

Power: 20W
110V
1200 lumens per head



Product code: 002727

SITE ELECTRICAL



SITE ELECTRICAL

LED WIDE BEAM HEAD LIGHT

120 lumens
Complete with
3 x AAA batteries



Product code: 009561

ELITE LED HAND TORCH

250 lumens
Beam of light up to 100m
3 x AAA batteries included



Product code: 009520

LED MAGNETIC SWIVEL TORCH

220 lumens
Main body has a ratcheting base,
allowing the torch to be angled
Magnetic base
3 x AAA batteries included



Product code: 009521

STALL CLIPS

4 pack



Product code: 009956

LED PREMIUM TORCH

400 lumens
Supplied with 2 x D batteries
10W high performance LED
Waterproof grade IP54
Beam distance: 300m
Complete with: Batteries, wrist
strap, belt loop, spare O ring,
button cover & storage pouch



Product code: 009321

HEAVY DUTY JUMP LEADS

Suitable for larger vehicles with a
battery start up power of 600A
Length: 3.6m



Product code: 002507

SITE ELECTRICAL



SITE ELECTRICAL

CABLE ACCESS KIT - 13 PCE

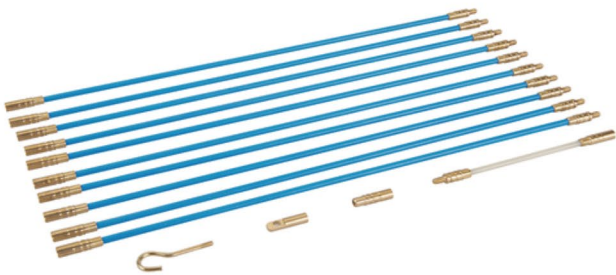

For gaining access to wire and cables under floorboards, ceiling ducts, wall cavities and trunking
Includes hook end, ring end and flexi-extender
Sizes in stock:

Product code: 330mm: 002521 1000mm: 002520

BELL WIRE CABLE CLIPS



Box of 100
Designed for securing and tidying a wide range of cabling types to wood, compressed board and masonry.
To fit 1.0mm

Product code: 010053

ROUND CABLE CLIPS



Box of 100
Designed for securing and tidying a wide range of cabling types to wood, compressed board and masonry

Product code: 6mm: 010054 9mm: 010055

FLAT & TWIN CABLE CLIPS



Box of 100
Designed for securing and tidying a wide range of cabling types to wood, compressed board and masonry.
To fit 10.0mm

Product code: 010056



WORKWEAR AND PPE

Mitchells
Ironmongers

WORKWEAR AND PPE



WORKWEAR & PPE

SNICKERS CRAFTMANS WINTER JACKET

Wind and water resistant
All round performance jacket
Colour: Black



Product code:

Size

005570

S

005571

M

005572

L

005573

XL

005574

XXL

SNICKERS ALL-ROUND INSULATED JACKET

Insulated work jacket for cold environments with 37.5 technology



Product code:

Size

003195

M

003196

L

003197

XL

SNICKERS RAIN JACKET

Completely waterproof
PU Coated
Conforms to EN 343



Product code:

Size

009393

M

009321

L

009141

XL

SNICKERS TOOL VEST

Provides durable and reliable tool-carrying functionality as well as plenty of options for practical storage



Product code:

Size

009379

M

009341

L

009354

XL

WORKWEAR AND PPE



WORKWEAR & PPE

SNICKERS LOGO HOODIE

BEST SELLER



Raised collar hoodie offering great warmth

Product code:	Size	Colour
005558	M	Grey
005561	M	Yellow
005564	M	Dark Blue
005559	L	Grey
005562	L	Yellow
005565	L	Dark Blue
005560	XL	Grey
005563	XL	Yellow
005566	XL	Dark Blue

SNICKERS CLASSIC LOGO HOODIE



Cotton-polyester blend with brushed inside.
 Logo made using two techniques, embroidery (Snickers) and print (Workwear)
 Thumb grip at cuffs
 Kangaroo pocket

Product code:	Size	Colour
010101	M	Black
010102	L	Black
010103	XL	Black
010104	M	Red
010105	L	Red
010106	XL	Red
010107	M	Green
010108	L	Green
010109	XL	Green

SNICKERS CRAFTSMAN HOLSTER POCKET SHORTS

Manufactured from durable rip-stop fabric
 Features Cordura reinforcements, holster pockets and phone compartment



Product code:	Colour	Waist (inches)
003074	Black	30
003075	Black	31
003076	Black	33
003077	Black	35
003078	Black	36
003079	Black	38
003080	Black	39
003081	Black	41

WORKWEAR AND PPE



WORKWEAR & PPE

RIP-STOP WORK SHORTS

Holster pockets
65% Polyester: 35% Cotton
Colour: Grey/Black



Product code:	Waist (inches)
003375	30
003373	32
003374	34
003376	36
003377	38

SNICKERS DURATWILL HOLSTER POCKET TROUSERS



Built to withstand everyday use and provide working comfort

Product code:	Colour	Waist (inches)	Length (inches)
003088	Black	31	30
003089	Black	33	30
003090	Black	35	30
003091	Black	36	30
003092	Black	38	30
003082	Black	30	32
003083	Black	31	32
003084	Black	33	32
003085	Black	35	32
003086	Black	36	32
003087	Black	38	32
003094	Black	31	35
003095	Black	33	35
003096	Black	35	35
003097	Black	36	35
003098	Black	38	35
003106	Black/Grey	31	30
003107	Black/Grey	33	30
003108	Black/Grey	35	30
003109	Black/Grey	36	30
003110	Black/Grey	38	30
003099	Black/Grey	30	32
003100	Black/Grey	31	32
003101	Black/Grey	33	32
003102	Black/Grey	35	32
003103	Black/Grey	36	32
003104	Black/Grey	38	32
003111	Black/Grey	31	35
003112	Black/Grey	33	35
003113	Black/Grey	35	35
003114	Black/Grey	36	35
003115	Black/Grey	38	35

WORKWEAR AND PPE



WORKWEAR & PPE

We Cut Keys!

SNICKERS CRAFTSMAN HOLSTER POCKET TROUSERS - RIP-STOP



Built to withstand everyday use without compromising on working comfort

Product code:	Colour	Waist (inches)	Length (inches)
003123	Black	30	30
003124	Black	33	30
003125	Black	35	30
003126	Black	36	30
003127	Black	38	30
003116	Black	30	32
003117	Black	31	32
003118	Black	33	32
003119	Black	35	32
003120	Black	36	32
003121	Black	38	32
003122	Black	39	32
003128	Black	31	35
003129	Black	33	35
003130	Black	35	35
003131	Black	36	35
003132	Black	38	35
003140	Steel grey/Black	30	30
003141	Steel grey/Black	33	30
003142	Steel grey/Black	35	30
003143	Steel grey/Black	36	30
003144	Steel grey/Black	38	30
003133	Steel grey/Black	30	32
003134	Steel grey/Black	31	32
003135	Steel grey/Black	33	32
003136	Steel grey/Black	35	32
003137	Steel grey/Black	36	32
003138	Steel grey/Black	38	32
003139	Steel grey/Black	39	32
003145	Steel grey/Black	31	35
003146	Steel grey/Black	33	35
003147	Steel grey/Black	35	35
003148	Steel grey/Black	36	35
003149	Steel grey/Black	38	35

WORKWEAR AND PPE



WORKWEAR & PPE

SNICKERS CANVAS HOLSTER TROUSERS

BEST SELLER



Built to offer protection and working comfort

Product code:	Colour	Waist (inches)	Length (inches)
003158	Brown	31	30
003159	Brown	33	30
003160	Brown	35	30
003161	Brown	36	30
003162	Brown	38	30
003151	Brown	30	32
003152	Brown	31	32
003153	Brown	33	32
003154	Brown	35	32
003155	Brown	36	32
003156	Brown	38	32
003157	Brown	39	32
003163	Brown	31	35
003164	Brown	33	35
003165	Brown	35	35
003166	Brown	36	35
003167	Brown	38	35

SNICKERS RUFFWORK TROUSERS



Holster pockets
Highly durable work trousers, ideal for demanding environments

Product code:	Colour	Waist (inches)	Length (inches)
003179	Grey/Black	31	30
006587	Grey/Black	33	30
003186	Grey/Black	35	30
003187	Grey/Black	36	30
006549	Grey/Black	33	32
003183	Grey/Black	35	32
003184	Grey/Black	36	32
003185	Grey/Black	38	32
003194	Brown/Black	31	30
005748	Brown/Black	33	30
003192	Brown/Black	35	30
003193	Brown/Black	36	30
003188	Brown/Black	33	32
003189	Brown/Black	35	32
003190	Brown/Black	36	32
003191	Brown/Black	38	32

WORKWEAR AND PPE



WORKWEAR & PPE

STANDARD HOLSTER POCKET WORK TROUSERS



Product code	Waist (inches)	Length	Colour
010063	28	S	Black
010064	30	S	Black
010065	32	S	Black
010066	34	S	Black
010067	36	S	Black
010068	38	S	Black
010057	28	R	Black
010058	30	R	Black
010059	32	R	Black
010060	34	R	Black
010061	36	R	Black
010062	38	R	Black
010075	28	S	Navy/Black
010076	30	S	Navy/Black
010077	32	S	Navy/Black
010078	34	S	Navy/Black
010079	36	S	Navy/Black
010080	38	S	Navy/Black
010069	28	R	Navy/Black
010070	30	R	Navy/Black
010071	32	R	Navy/Black
010072	34	R	Navy/Black
010073	36	R	Navy/Black
010074	38	R	Navy/Black
010087	28	S	Grey/Black
010088	30	S	Grey/Black
010089	32	S	Grey/Black
010090	34	S	Grey/Black
010091	36	S	Grey/Black
010092	38	S	Grey/Black
010081	28	R	Grey/Black
010082	30	R	Grey/Black
010083	32	R	Grey/Black
010084	34	R	Grey/Black
010085	36	R	Grey/Black
010086	38	R	Grey/Black

Durable polycotton fabric for high performance and maximum wearer comfort
 50+ UPF rated fabric to block 98% of UV rays
 Reflective piping for increased visibility
 12 Pockets for ample storage
 Free pair of kneepads included with this trouser
 Top-loading knee pad pockets for quick and easy access
 Gripper elasticated inner waistline helping keep upper body garments in place
 Side elastic waist for ultimate wearer comfort
 Adjustable hem to accommodate all leg lengths
 Swing away tool pockets

WORKWEAR AND PPE



WORKWEAR & PPE

<p>SNICKERS LOGO BELT</p>  <p>Fixed belt with non-scratch buckle</p> <p>Quick and easy lock system</p> <p>Size: 130cm</p> <p>Product code: 003170</p>	<p>SNICKERS LOGO BELT</p>  <p>One size</p> <p>Colour: Black/Grey</p> <p>Product code: 005986</p>	<p>SNICKERS ERGONOMIC BELT</p>  <p>One size</p> <p>Product code: 003199</p>
<p>SNICKERS WOOL FUSION MID SOCKS</p>  <p>Colour: Black/Grey</p> <p>Size: 43 - 45</p> <p>Product code: 003173</p>	<p>SNICKERS WOOL TECH HIGH SOCKS</p>  <p>Colour: Black/Grey</p> <p>Size: 43 - 45</p> <p>Product code: 003174</p>	<p>SNICKERS WOOL ALL-ROUND WORK SOCKS</p>  <p>Colour: Black</p> <p>Sizes in stock:</p> <p>Product code: 41 - 44: 003175 45 - 48: 003176</p>
<p>SNICKERS ELASTIC BRACES</p>  <p>One size</p> <p>Product code: 003198</p>	<p>SNICKERS CRAFTSMEN KNEE PADS</p>  <p>Lightweight design and flexible construction</p> <p>Product code: 003201</p>	<p>STANDARD KNEE PADS</p>  <p>To fit knee pad pockets</p> <p>Product code: 010094</p>
<p>SNICKERS KNEE PADS - D30 LITE</p>  <p>D30 material provides impact protection combined with a lightweight and ventilated design</p> <p>Product code: 003171</p>	<p>SNICKERS FLOOR LAYERS KNEE PADS</p>  <p>Colours: Black/Light grey</p> <p>Polyethylene beads ensure the pads keep their shape over time</p> <p>Product code: 003203</p>	<p>STRAP FITTING KNEE PADS</p>  <p>Hardwearing outer shell</p> <p>Adjustable straps</p> <p>CE Certified</p> <p>Product code: 010093</p>

WORKWEAR AND PPE



WORKWEAR & PPE

SNICKERS POWER CORE GLOVES

Tested to EN 388
Reinforced work gloves with reliable protection



Product code: 003177

SNICKERS POWER OPEN GLOVE

Tested to EN 388
Reinforced work gloves with reliable protection



Product code: 003178

SNICKERS BEANIE



Product code: 003169

SNICKERS WINTER HAT

Features padded polyester insulation and fur lining for warmth and comfort

Sizes in stock:



Product code: M: 009148
L: 009614

SNICKERS FLEXI HAMMER HOLDER



Metal hammer holder

Product code: 003200

MAGMA DRILL HOLSTER



Product code: 003949

PADDED TOOLBELT SET

Includes padded belt, tool pouch and drill holster



Product code: 010095

MAGMA CONTRACTOR'S ORGANISER



Product code: 003950

MAGMA MINI BAG

Size: 42 x 28 x 28cm



Product code: 003951

MAGMA MAXI BAG

Size: 55 x 33 x 30cm



Product code: 003952

MAGMA TECHNICIANS TOTE

Size: 30 x 39 x 29cm



Product code: 003955

WORKWEAR AND PPE



WORKWEAR & PPE

MAGMA TECHNICIAN'S RUCKSACK



Size: 38 x 42 x 25cm

Product code: 003953

MAGMA TECHNICIANS TOOL CASE



Size: 46 x 33 x 21cm

Product code: 003954

MAGMA ESSENTIAL TOOL POUCH



Product code: 003966

MAGMA BUILDERS TOOL POUCH



Product code: 003959

MAGMA NAIL POUCH



Product code: 003967

MAGMA ELECTRICIANS TOOL POUCH



Product code: 003960

MAGMA TOOL ROLL



Product code: 003961

MAGMA PRO WHEELED CASE

Dimensions:
430 x 300 x 470mm
Weight: 6.25kg



Product code: 008580

WORKWEAR AND PPE



WORKWEAR & PPE

We Cut Keys!

MAGMA CHISEL ROLL



Product code: 003962

MAGMA HAMMER LOOP



Product code: 003963

MAGMA TOOL TOTE



Size: 49 x 44 x 29cm

Product code: 003956

MAGMA TECHNICIANS VEST



Product code: 008978

MAGMA MOBILE PHONE HOLDER



Product code: 003964

POLYESTER/COTTON BOOT LACE



Sold as a pair
Length: 150cm

Product code:

HONEY NUBUCK BOOTS

Steel midsole and toe protection

Heat resistant to 300 degrees celcius

Slip resistant to BS EN ISO 20344:2004/A1:2007



Product code:

UK Size

003212

6

003213

7

003214

8

003215

9

003209

10

003210

11

003211

12

HONEY NUBUCK TRAINERS

Steel toe cap to EN ISO 20345:2004

Steel midsole
Heat resistant to 300 degrees celcius

Slip resistant to BS EN ISO 20344:2004/A1:2007



Product code:

UK Size

003219

7

003220

8

003221

9

003216

10

003217

11

003218

12

WORKWEAR AND PPE



WORKWEAR & PPE

BROWN NUBUCK SAFETY BOOT

Non-metallic toe-cap
to EN ISO 20345:2004

Non-metallic midsole protection
to EN ISO 20345:2004

Heat resistant to
300 degrees celcius

Slip resistant to
BS EN ISO 20344:2004/A1:2007



Product code:

UK Size

003251

7

003225

8

003250

9

003222

10

003223

11

003224

12

BLACK FULLY WATERPROOF SAFETY BOOT

Composite midsole and
toe cap protection

Anti-static

Heat resistant to
300 degrees celcius

Slip resistant to
BS EN ISO 20344:2004/A1:2007



Product code:

UK Size

003229

7

003230

8

003231

9

003226

10

003227

11

003228

12

BROWN FULLY WATERPROOF SAFETY BOOT

Composite midsole and
toe cap protection

Heat resistant to
300 degrees celcius

Slip resistant to
BS EN ISO 20344:2004/A1:2007



Product code:

UK Size

003235

7

003236

8

003237

9

003232

10

003233

11

003234

12

RIGGER BOOTS

Anti-static

Oil resistant

Steel midsole and
toe cap protection

Heat resistant to
200 degrees celcius

Slip resistant to
BS EN ISO 20344:2004/A1:2007



Product code:

UK Size

003241

7

003242

8

003243

9

003238

10

003239

11

003240

12

WORKWEAR AND PPE



WORKWEAR & PPE

BLACK HIMALAYAN FULLY WATERPROOF SAFETY BOOT

- Steel midsole and toe cap protection
- Oil resistant
- Anti-static sole
- Slip resistant to BS EN ISO 20344:2004/A1:2007
- Heat resistant to 300 degrees celcius



STANDARD BLACK WORK BOOTS

BEST SELLER

- Steel toe cap and midsole
- Antistatic
- Oil and acid resistant
- Anti-slip sole to BS EN ISO 20344:2004/A1:2007
- Heat resistant to 200 degrees celcius



Product code:

UK Size

003244

7

003245

8

003246

9

003247

10

003248

11

003249

12

Product code:

UK Size

006533

7

006534

8

006535

9

006536

10

006537

11

006538

12

BUCKBOOTZ HIGH VISIBILITY WATERPROOF SAFETY BOOT

- Anti-scuff toe protector
- Antistatic
- Composite toe cap
- Heat & oil resistant rubber outsole
- Non-marking soles
- Slip resistant - max test
- Water resistant uppers
- Sole - Buckz Viz rubber sole



CATERPILLAR BLACK LEATHER SAFETY BOOT

- Outsole slip resistant to EN ISO 20345 : 2011
- 200 joule toecap protection
- Steel toe and midsole
- Heat resistant to 300 degrees Celsius



Product code:

UK Size

006593

7

006954

8

006595

9

006596

10

006597

11

006599

12

Product code:

UK Size

008581

7

008582

8

008583

9

008584

10

008524

11

008525

12

WORKWEAR AND PPE



WORKWEAR & PPE

BLACK EVA RUBBER SAFETY SHOE

Steel midsole and toe caps

Anti-static

Oil resistant
Heat resistant to 300 degrees celcius

Slip resistant to BS EN ISO 20344:2004/A1:2007



Product code:

UK Size

003274

7

003275

8

003276

9

003271

10

003272

11

003273

12

BLACK ICONIC SAFETY SKATER SHOE

Steel midsole and toe cap

Slip resistant to BS EN ISO 20344:2004/A1:2007

Heat resistant to 300 degrees celcius



Product code:

UK Size

003280

7

003281

8

003282

9

003277

10

003278

11

003279

12

SAFETY WELLINGTONS

Steel toe cap and midsole
CE Certified

Anti-static

100% Waterproof

Slip resistant - SRC rated

Puncture resistant midsole

Oil and fuel resistant outsole

Height: 40cm



BUCKBOOTZ PREMIUM WELLINGTONS

Antistatic

Cold insulation certified to -17°C for 30 minutes

Detachable cushion insoles

Oil resistant rubber outsole

Slip resistant - max test

Steel anti-penetration midsole

Steel safety toe cap

Structured aerspenser honeycomb breathable lining

Waterproof

Sole - K3 Rubber Sole



HI-VIS TWO BAND AND BRACE VEST



Conforms to EN ISO 20471 class 2

Product code:

UK Size

003316

7

003317

8

003318

9

003319

10

003320

11

003321

12

003322

13

Product code:

UK Size

006591

7

006590

8

006588

9

006586

10

006585

11

006592

12

016592

13

Product code

Colour

Size

003288

Yellow

S/M

003287

Yellow

L/XL

003289

Yellow

XXL/3XL

006284

Yellow

4XL/5XL

003286

Orange

S/M

003285

Orange

L/XL

003284

Orange

XXL/3XL

003283

Orange

4XL/5XL

WORKWEAR AND PPE



WORKWEAR & PPE



HI-VIS TRAFFIC JACKET



Certifications:
 Railway standard RIS 3279-TOM (Orange only)
 EN 343 Class 3:1
 EN 342
 EN ISO 20471 class 3

H-VIS BOMBER JACKET



Certifications
 EN 343 Class 3:1
 EN 342
 EN ISO 20471 class 3
 Colour: Yellow

Product code:	Colour	Size
003292	Orange	S
003291	Orange	M
003290	Orange	L
003293	Orange	XL
003294	Orange	XXL
003295	Orange	XXXL
003298	Yellow	S
003297	Yellow	M
003296	Yellow	L
003299	Yellow	XL
003300	Yellow	XXL
003301	Yellow	XXXL

Product code:	Size
003304	S
003303	M
003302	L
003305	XL

WORKWEAR AND PPE



WORKWEAR & PPE

HI-VIS TRAFFIC TROUSERS



Certifications
Railway standard
RIS 3279-TOM (Orange only)
EN 343 Class 3:1
EN ISO 20471 class 1

EXECUTIVE HI-VISIBILITY VESTS

- Reflective tape for increased visibility
- Front zip opening for easy access
- Two lower patch pockets
- Phone and pen holder pocket
- D-ring for keys or ID cards
- Dual ID holder allows use of both portrait and landscape ID card display
- Radio loop for easy clipping of a radio
- Certified to EN ISO 20471 after 50 x washes
- Complies with RIS 3279-TOM for rail (orange only)
- CE certified



Product code	Colour	Size
003312	Yellow	S
003311	Yellow	M
003310	Yellow	L
003313	Yellow	XL
003314	Yellow	XXL
003315	Yellow	XXXL
003308	Orange	S
003307	Orange	M
003306	Orange	L
003309	Orange	XL

Product code	Size	Colour
008956	S	Yellow
008957	M	Yellow
008958	L	Yellow
008959	XL	Yellow
008960	XXL	Yellow
008961	XXXL	Yellow
008962	S	Orange
008963	M	Orange
008964	L	Orange
008965	XL	Orange
008966	XXL	Orange
008967	XXXL	Orange

WORKWEAR AND PPE



WORKWEAR & PPE



ZIP BOILER SUIT



Durable polycotton fabric
8 pockets for ample storage

Product code:	Colour	Size
003325	Black	S
003324	Black	M
003323	Black	L
003326	Black	XL
003327	Black	XXL
003330	Navy	S
003329	Navy	M
003328	Navy	L
003331	Navy	XL
003332	Navy	XXL

OX THERMAL GLOVES

BEST SELLER

Provide great warmth in cold conditions
Complete water resistance
Anti-slip sandy coating
Conforms to EN 388 and EN 511

Sizes in Stock:



**Product code: Large (9): 003419
XL (10): 006998**

STOCKINETTE KNIT WRIST GLOVE

Suitable as a liner for extra warmth
Size: XL (10)



Product code: 003420

PREMIUM WORK GLOVE

BEST SELLER

Secure handling in both wet and dry conditions
ANSI abrasion level 2
Conforms to EN 388:2016 and EN 420
Colour will vary depending on size
Sizes in stock:



**Product code: Large (9): 006999
XL (10): 003422 XXL (11): 003421**

STANDARD WORK GLOVE

CE Certified
Perfect for intricate tasks

ANSI cut level A1

Smooth PU Coating
Colour may vary depending on size
Sizes in stock:



**Product code: Large (9): 003424
XL (10): 003423 XXL (11): 003425**

LEATHER DRIVERS' GLOVE

CE Certified

Insulatex lined for added warmth and comfort

Size: XL (10)



Product code: 003427

PVC KNIT WRIST GLOVES

CE Certified

Fully coated for maximum liquid protection

ANSI abrasion level 3

12-gauge liner for dexterity

Size: XL (10)



Product code: 003428

WORKWEAR AND PPE



WORKWEAR & PPE

WELDERS GAUNTLET

CE Certified
Maximum EN407 burn behaviour resistance
Ideal for welding and metal handling
ANSI abrasion level 3
Size: XL (10)



Product code: 003429

CUT RESISTANT GLOVE

CE Certified
Level D cut resistance
Tested for both cut and heat protection
13-gauge liner for perfect fit
ANSI cut level 4
Size: XL (10)



Product code: 003430

CUT RESISTANT SLEEVES

Length: 18 inches
CE Certified
Level D cut resistance
ANSI cut level 4
Seamless 13-gauge liner



Product code: 003431

ANTI-VIBRATION GLOVE

CE Certified
Specially designed to resist the effects of vibration
For use with jack hammers, concrete breakers
10-gauge liner for dexterity
Size: XL (10)



Product code: 003432

HOUSEHOLD LATEX GLOVES

CE Certified
Water and oil resistant
Textured pattern for enhanced grip
Size: XL (10)



Product code: 003433

DOUBLED DIPPED PVC GAUNTLET

CE Certified
Sandy palm finish for enhanced grip
Chemical resistant gauntlet
Length: 45cm
Size: XL (10)



Product code: 003434

BLACK DIMPLED DISPOSABLE GLOVES

Powder-free
Textured inside to maximise grip
Good chemical resistance
Can be used with an inner glove
Suitable for people allergic to latex
Maximum level of dexterity according to CE standards
Box of 50
Size: L (9)



Product code: 003378

DISPOSABLE LATEX GLOVES

CE certified
GMO free
Manufactured from natural rubber
Boxes of 100
Sizes in stock



Product code: Large (9): 003379
XL (10): 003380

POWDER-FREE NITRILE DISPOSABLE GLOVE

CE Certified
Manufactured from synthetic nitrile rubber to eliminate the risk of allergic reactions to latex
Boxes of 100
Size: L (9)



Product code: 003381

ZEKLER PREMIUM YELLOW GLASSES

UV resistant
Scratch resistant lens
Anti-fog treated lens
Complies with EN 166 class 1F and EN 170



Product code: 003383

ZEKLER PREMIUM GREY GLASSES

UV400 protection
Scratch resistant lens
Anti-fog treated lens
Complies to EN 166 class 1FTN and EN 172



Product code: 003385

ZEKLER WELDING GLASSES

Welding filter
Protection against UV and IR
Scratch resistant lens
Conforms to EN 166 class 1F and EN 169 refractive index 3 or 5



Product code: 003387

WORKWEAR AND PPE



WORKWEAR & PPE

We Cut Keys!



<p>ZEKLER BLACK/GREY GLASSES</p> <p>UV400 protection Scratch resistant lens Anti-fog treated lens Complies with EN 166 class 1FN and EN 172</p>  <p>Product code: 003388</p>	<p>ZEKLER HYBRID SPECS</p> <p>Colour: smoke Polycarbonate lens Soft nose bridge and sealing edge that fits tight Includes adjustable neckband and detachable sidepieces UV400 HC/AF = scratch resistant and anti-fog treated lens Complies with EN 166, class 1FN and EN 172</p>  <p>Product code: 003386</p>	<p>HYBRID SPECS</p> <p>Comfort of spectacles with fit and seal of a goggle CE Certified 99% UV protection Anti-scratch coating Anti-fog coating 100% metal free Free spec cord Clear lens</p>  <p>Product code: 003390</p>
<p>CURVED SPECS</p> <p>CE Certified 99% UV protection Anti-scratch coating Adjustable length Clear lens</p>  <p>Product code: 003391</p>	<p>STANDARD SAFETY SPECS</p> <p>CE Certified 99% UV protection Anti-scratch coating Free spec cord Colours in stock:</p>  <p>Product code: Amber: 003394 Smoke: 003396 Clear: 003395</p>	<p>INDIRECT VENT GOGGLE</p> <p>CE Certified 99% UV protection Indirect ventilation Flexible PVC frame Ultra-lightweight</p>  <p>Product code: 003392</p>
<p>PANORAMIC GOGGLES</p> <p>CE Certified 99% UV protection Anti-scratch coating Anti-fog coating Indirect ventilation Single panoramic lens Excellent side protection</p>  <p>Product code: 003393</p>	<p>COMFORT MASK</p> <p>Pack of 50 Provides relief from non-toxic nuisance dusts Effective against pollen Non-certified</p>  <p>Product code: 003400</p>	<p>DISPOSABLE FLAT VALVED FACE MASK</p> <p>Protects against non-toxic dusts, fibres, and aqueous mists Conforms to EN 149 Sold individually FFP3</p>  <p>Product code: 003399</p>
<p>VALVED RESPIRATOR</p> <p>CE-CAT 3 FFP2 Protects against fine toxic dust, fumes, and water-based mist High performance exhalation valve to reduce heat and provide comfort Pack of 10</p>  <p>Product code: 003401</p>	<p>VALVED FOLD FLAT RESPIRATOR</p> <p>CE-CAT 3 Exhalation valve for lighter breathing resistance Nose clip for optimised fit FFP2 Pack of 20</p>  <p>Product code: 003402</p>	<p>FFP3 VALVED BLISTER PACK</p> <p>Pack of 2 Protects against a high concentration of dust, water-based mist and fumes CE-CAT 3 High performance exhalation valve to reduce heat and provide comfort Adjustable straps for secure fit</p>  <p>Product code: 003403</p>

WORKWEAR AND PPE



WORKWEAR & PPE

<p>COMBINATION FILTER PACK</p> <p>Pack of 4 To suit half mask Screw-in connection This anti-gas and anti-particle filter protects from organic and inorganic acidic gases and vapours, sulphur dioxide, ammonia, and its derivatives Class 1 filter for gases and class 3 for particles Protects against harmful substances, solvents, toxic particles, and micro-organisms CE-CAT 3</p>  <p>Product code: 003405</p>	<p>HALF MASK</p> <p>Provides a large field of vision Manufactured from non-allergenic TPE material Sweat port for hot and humid conditions Conforms to EN140 CE-CAT 3 Screw-in connection Filters sold separately Adjustable straps</p>  <p>Product code: 003404</p>	<p>OVERSHOES</p>  <p>Size: 40cm/16" Pack of 100</p> <p>Product code: 003411</p>	<p>TYVEK CLASSIC HOODED COVERALL</p> <p>Type 5/6 hooded coverall</p> <p>Conforms to EN 13034 type 6, EN 13982 type 5, EN 1073 (radioactive particulates), EN 1149-1 (Antistatic) and EN 14126</p> <p>Sold individually</p> <p>Sizes in stock:</p>  <p>Product code: XL: 003412 XXL: 003413</p>
<p>PU FOAM EAR PLUGS</p> <p>CE-CAT 3</p> <p>Sold in pairs or as a box of 200 pairs</p>  <p>Product code: 003408</p>	<p>ULTRA-FIT CORDED EAR PLUGS</p> <p>Comfortable and secure fit</p> <p>32dB of protection</p> <p>Sold in pairs or as a box of 50</p>  <p>Product code: 003407</p>	<p>EYE SAFETY STATION</p> <p>Can be wall mounted</p> <p>Contents: 2 x 500ml eye wash solution, 2 x no16 sterile pads</p>  <p>Product code: 003414</p>	
<p>FIRST AID KIT - 10 PERSONS</p> <p>Contents: 6 safety pins, 4 triangular bandages, 2 x eye pad sterile dressing, 6 x medium sterile dressing, 2 x large sterile dressing, 1 x pair of nitrile disposable gloves, 6 x saline cleansing wipes, 1 bag of wash-proof plasters, 1 guidance leaflet</p>  <p>Product code: 003415</p>	<p>WATERPROOF PLASTERS</p> <p>Pack of 100</p>  <p>Product code: 008653</p>	<p>BROW GUARD</p> <p>Elasticated headband</p>  <p>Product code: 003397</p>	
<p>COMFORT EAR PROTECTOR</p> <p>Contains broad foam cushions for comfort and high impact ABS cups</p> <p>CE-CAT 3</p> <p>Adjustable length</p> <p>Padded headband for comfort</p>  <p>Product code: 003410</p>	<p>CLASSIC EAR PROTECTOR</p> <p>Lightweight and robust CE-CAT 3 Adjustable length 100% metal free</p>  <p>Product code: 003409</p>	<p>CLEAR VISOR</p> <p>To suit brow guard Size: 200mm Conforms to EN166 1B 3</p>  <p>Product code: 003435</p>	

WORKWEAR AND PPE



WORKWEAR & PPE



SAFETY HELMET

CE-CAT 3
 Electrical properties (440V AC)
 Electrical insulation - conforms to 50365
 4 points plastic suspension harness
 Contains soft foam sweat band
 Colours in stock:



Product code: Yellow: 003437
White: 003436

PRO SAFETY HELMET

Extended peak to minimise glare
 4 points nylon webbing harness
 CE Certified
 Buckle size adjustment for easy fitting
 Soft foam sweatband included
 Colours in stock:



Product code: Yellow: 003440
White: 003439 Blue: 003438

CLIMBING HELMET

Vented helmet, adapted for working at heights
 6-point harness and buckle adjustment
 4 points chin strap included
 CE Certified
 Soft foam sweatband included
 Colour: Yellow



Product code: 003443

NYLON CHIN STRAP



Product code: 003441

FALL ARREST AND RESTRAINT HARNESS

Adjustable chest, waist, and thigh straps
 Conforms to EN 361 and EN358



Product code: 002485

BUMP CAP

CE Certified
 Conforms to EN 812
 Long peak for maximum protection against shock and light inner ABS shell and soft pad for shock absorption



Product code: 003442

SCREWGATE KARABINA

Forged alloy steel
 Max gate opening: 19mm
 100% proof loaded to 16kN
 Max breaking strength: 25kN
 Weight: 170g
 Conforms to EN362



Product code: 002487

ENERGY ABSORBING LANYARD

Size: 1.5m
 Conforms to EN 362 and EN355
 Attaches fall arrest harness to suitable anchorages



Product code: 002486



BAGGED AGGREGATES

Mitchells
Ironmongers

BAGGED AGGREGATES



BAGGED AGGREGATES

MULTI-PURPOSE COMPOST		GENERAL PURPOSE CEMENT		DECORATIVE BARK											
<p>Size: 40L</p> <p>Brand may vary</p> 	<p>Size: 25kg</p> <p>Weather-proof bag</p> <p>Brand may vary</p> 	<p>Brand may vary</p> <p>Size: 100L</p> 													
Product code: 000409		Product code: 000416		Product code: 000410											
POST FIX		ROCK SALT		BUILDING AGGREGATES											
<p>BEST SELLER</p> <p>20Kg bag</p> 	<p>Supplied in 20Kg bags</p> <p>Two types in stock:</p> <p>Brand may vary</p> 	<p>Supplied in 25KG bags</p> <p>Brand may vary</p> 													
Product code: 000415		Product code: White: 009364 Brown: 000417		<table border="1"> <thead> <tr> <th>Product code:</th> <th>Product</th> </tr> </thead> <tbody> <tr> <td>000413</td> <td>Yellow building sand</td> </tr> <tr> <td>000414</td> <td>Red building sand</td> </tr> <tr> <td>000412</td> <td>Sharp sand</td> </tr> <tr> <td>000411</td> <td>Ballast</td> </tr> </tbody> </table>		Product code:	Product	000413	Yellow building sand	000414	Red building sand	000412	Sharp sand	000411	Ballast
Product code:	Product														
000413	Yellow building sand														
000414	Red building sand														
000412	Sharp sand														
000411	Ballast														
GRAVEL	SLATE CHIPPINGS	COTSWOLD CHIPPINGS	WHITE CHIPPINGS												
 <p>25Kg bag</p>	 <p>25Kg bag</p>	 <p>25Kg bag</p>	 <p>25Kg bag</p>												
Product code: 10mm: 008886 40mm: 008165	Product code: 009361	Product code 009136	Product code: 007747												



CALOR GAS

Mitchells
Ironmongers

CALOR GAS



CALOR GAS

PROPANE 3.9KG



Product code: 000746

BUTANE 4.5KG



Product code: 000751

BBQ 5KG



Product code: 000757

CUBE 6KG



Product code: 010026

PROPANE 6KG



Product code: 000748

PROPANE LITE 6KG



Product code: 000749

BUTANE 7KG



Product code: 000752

PROPANE 13KG



Product code: 000743

BBQ 13KG



Product code: 000756

BUTANE 15KG



Product code: 000750

AUTOMOTIVE PROPANE 18KG



Product code: 000744

PROPANE 19KG



Product code: 000745

CALOR GAS



CALOR GAS

PROPANE 47KG



Product code: 000747

PRIMUS 2000



Product code: 000760

CAMPING GAZ 904



Product code: 000754

CAMPING GAZ 907



Product code: 000755

GAS SPANNER



Product code: 000776

CAMPING GAZ REGULATOR



Product code: 000774

PATIO/BBQ GAS REGULATOR



Product code: 000775

PROPANE GAS REGULATOR



Product code: 000770

BUTANE GAS REGULATOR



Product code: 000769

BUTANE CLIP-ON GAS REGULATOR



Product code: 000768

AUTO BLOW LAMP

Gas included
Flame temperature:
1750 degrees



Product code: 000767

BUTANE/PROPANE GAS CARTRIDGE

Sizes in stock:



Product code: 170g: 000762
350g: 000766

CALOR GAS



CALOR GAS

**We Cut
Keys!**

BUTANE GAS CARTRIDGES - 4 PK



Cartridge size: 227g

Product code: 000773

LPG HIGH PRESSURE GAS HOSE



Diameter: 8mm
Sold by the metre

Product code: 000779

PORTABLE GAS HEATER

**BEST
SELLER**



For use with the Calor Cube gas
Easy click bottle connection
2-year guarantee

Product code: 010025

CABINET HEATER



For use with 15Kg
Calor butane gas

Product code: 010024

From the Anvil[®]

Specialist Manufacturers of Ironmongery & Lighting

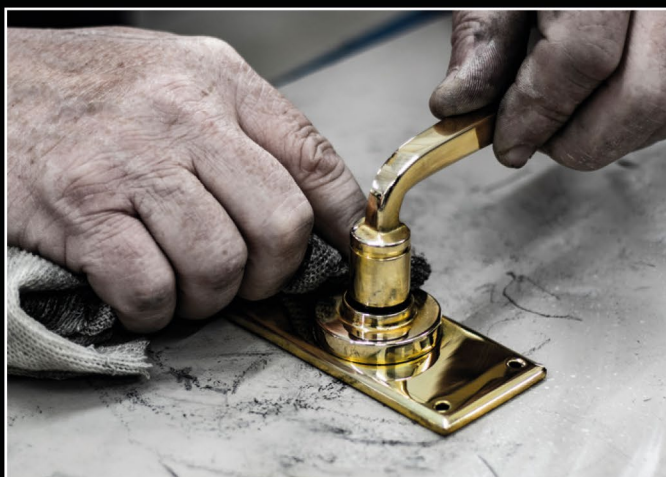

Your local **From The Anvil** stockist

Tel: **01623 650 065**
Email: **sales@mitchellsironmongers.co.uk**

© Copyright Mitchells Ironmongers Ltd. 2021

Mitchells Ironmongers Ltd, Kestral Road, Mansfield, Nottinghamshire, NG18 5FT
Web: www.mitchellsironmongers.co.uk
